

MEDIT Scan for Clinics



Revision 17
May 2024



Medit Link

Revision 17 (May 2024)

Contents

Medit Scan for Clinics	1
Introduction	1
Medit Scan for Clinics	1
Intended Use	1
Contraindications	1
Qualification of Operating User	1
Installation	2
System Requirements	2
System Requirements for Windows	2
Minimum System Requirements	3
Installation of Medit Scan for Clinics	4
Installation	4
Updates	4
Software Update	4
Firmware Update	4
Scanner Connection	7
Scanner Status	7
Hub Status	8
Pairing Manager	9
Switch & Scan	12
Scanner Calibration	14
Intra Oral Scanner Calibration	14
How to Calibrate (i500, i600, i700, i700 wireless)	15
How to Calibrate (i900)	19
Getting Started	23
User Interface	23
Overview	23
Title Bar	24
Main Toolbar	25
Form Information	25
Info Box	25

Scan Stages	26
Model View	26
Scan Information	27
Data Tree	27
Side Toolbar	28
Scan Stage Toolbar	28
Live View	28
Scan Depth	30
Settings	31
Program Preferences	32
General	32
Interface	32
Data Display	33
Scanning Assistance	33
Scanning Performance	35
Post-Processing	36
High-Resolution Data Processing	36
Scanner	37
Touch Gestures (i900 only)	38
On Battery Power (i700 wireless only)	38
When Plugged In	39
Smart Scan Review	39
Preparation Review	39
Distances	39
Tooth Reduction Depth	40
Basic Operation	41
3D Data Control	41
3D Data Control Using a Mouse	43
3D Data Control Using Mouse and Keyboard	43
3D Mouse Support	43
3D Data Control Using Scanner Buttons (i700/i700w)	44
3D Data Control Using Touch Interfaces (i900)	44
Scanning Operation	45
Start/Stop with Scan Button (unavailable with i900)	45
Start/Stop with Touch Band (i900 only)	45
Start/Stop by Lifting/Putting Scanner (i900 only)	45
Scanning Basics	46
Scanning Checklist	46
Practice Mode	47
Entering Practice Mode	48
Scanning Practice	53
Touch Interface Tutorial	55
Smart Arrow	56
Smart Scan Guide	59

Scan Stages	61
Stage Management	61
Stages Management	61
Scan Stages	62
Add/Remove Stages	63
Save as Default Workflow	65
Change Stage Order	67
Pre-Op for Maxillar/Mandible	69
Pre-Op for Maxilla Stage	69
Pre-Op for Mandible Stage	69
Additional Tool in Pre-Op Stage	69
Maxillar/Mandible	70
Maxilla Stage	70
Mandible Stage	70
Additional Tools in Maxillar/Mandible Stage	71
Scan Body	72
Maxillary Scan Body Stage	72
Mandibular Scan Body Stage	72
Additional Tools for Scan Body Stage	72
Replicate Existing Data	73
Edentulous Maxilla/Mandible	75
Edentulous Maxilla Stage	75
Edentulous Mandible Stage	76
Additional Tools for Edentulous Stage	76
Maxillary/Mandibular Denture	77
Maxillary Denture Stage	77
Mandibular Denture Stage	77
Occlusion	78
Occlusion Stage	78
Additional Tools for Occlusion Stage	79
Multi Occlusion	80
Occlusion Target for Maxilla/Mandible	84
Align with Occlusal Plane	85
Mandibular Movement	89
Face	96
Face Stage	96
Additional Tools for Face Stage	96
Additional Data	97
Additional Data Stage	97
Smart Scan Review	100
Smart Scan Reive Stage	100
Smart Scan Reive Report	101

Tools for Smart Scan Review	102
Smart Scan Review Process	103
Complete	107
Complete Stage	107
Tools and Functions.....	110
Scan Stage Tools	110
Basic Scanning Tools	110
High Resolution Scan	111
Import Scan Data	112
Filtering Tools	114
Smart Color Filtering	115
Smart Stitching	117
Advanced Tools	121
Main Toolbar Tools	122
Trimming Tools	122
Polyline Trimming	122
Brush Trimming	123
Manual Noise Trimming	124
Automatic Noise Trimming	125
Quick Trimming	125
Function Tools	126
Lock Area	128
Undercut Analysis	129
Undercut Analysis with Auto Direction	129
Undercut Analysis with Manual Direction	131
Swap Maxilla and Mandible	131
Result Preview	132
Margin Line	133
Smart Data Cleaning	137
Scan Replay	140
HD Camera	141
Register Abutments	143
Smart Shade Guide	149
Side Toolbar Tools	154
Case and Workflow Examples.....	156
Denture Scan	156
Full Denture	156
Acquire Edentulous Scan Data	157
Relined Denture Scan	159
Denture Replica	161
Implant Supported Denture	162
Pre-Op Scan	164

How to Utilize Pre-Op Scan	164
How to Utilize Pre-Op Scan With Trimming Tools	166
How to Delete Replicated Pre-Op Scan and Scan New Data	169
Impression Scan	173
How to Acquire Impression Scan	173
How to Utilize Impression Scan for Margins	176
How to Utilize Impression Scan for Post & Core Case	178
How to Utilize Impression Scan for Occlusion Case	179
Abutment Library Matching	181
How to Use Abutment Library Matching	182
Assign Abutment Library	182
Align Abutment Library	185
Scan Body Library Matching	187
How to Use Scan Body Library Matching	188
Assign Scan Body Library	188
Align Scan Body Library	191
Preparation Review	193
How to Use Preparation Review	194
Preparation Review Settings	194
Utilizing Preparation Review Tools	195

Medit Scan for Clinics

Introduction

Medit Scan for Clinics

Medit Scan for Clinics is a software program that provides a user-friendly working interface to digitally record topographical characteristics of teeth, and the surrounding tissues, using the scanner.

Intended Use

The system is a 3D dental scanner used to record the topographical characteristics of teeth and surrounding tissues digitally. The system produces 3D scans for computer-aided design and manufacturing of dental restorations.

The system is for patients who require 3D scanning for dental treatments, such as:

- Single Custom Abutment
- Inlays & Onlays
- Single Crown
- Veneer
- 3 Unit Implant Bridge
- Up to 5 Unit Bridge
- Orthodontics
- Implant Guide
- Diagnostic Model

The scanner can also be used for full mouth scans. However, factors such as intraoral conditions, the technician's level of expertise, and the prosthetic fabrication process can all affect the final result.

Contraindications

This scanner is not designed to acquire images of the internal structure of teeth or supporting skeletal structures.

Qualification of Operating User

This scanner should be used by trained dental professionals and dental laboratory technicians. The user of this scanner is solely responsible for determining whether or not this scanner is suitable for a particular patient case. The user is solely responsible for the accuracy, completeness, and adequacy of any data obtained by the scanner and the accompanying software. The user must verify the accuracy and adequacy of results for appropriate treatment. The system must be used in accordance with the user guide and the cautions. Additionally, the user should not modify or change the system. Improper use or handling of the system will void any warranty. For more information on how to use the system properly, please contact your local distributor.

Installation

System Requirements

System Requirements for Windows

	Windows		macOS
	Laptop	Desktop	Laptop/Desktop
CPU	Intel Core i7 - 13700H Intel Core i7 - 12700H AMD Ryzen 7 7735H AMD Ryzen 7 6800H	Intel Core i7 - 13700K Intel Core i7 - 12700K AMD Ryzen 7 7700X AMD Ryzen 7 5800X	M1 Pro (10-core CPU, 16-core GPU) M2 (8-core CPU, 10-core GPU) M2 Pro (10-core CPU, 16-core GPU)
RAM	32 GB		24 GB
Graphics	NVIDIA GeForce RTX 4060 (VRAM 8 GB or higher) NVIDIA GeForce RTX 3070 (VRAM 8 GB or higher) NVIDIA RTX A3000 (VRAM 8 GB or higher) * AMD Radeon is not supported		-
OS	Windows 10 64-bit Windows 11 (recommended for 12th Gen or Intel Core processors)		Monterey 12 Ventura 13

Minimum System Requirements

	Windows		macOS
	Laptop	Desktop	Laptop/Desktop
CPU	Intel Core i5 - 13500H Intel Core i5 - 12500H AMD Ryzen 5 7735HS AMD Ryzen 5 6600H	Intel Core i5 - 13400 Intel Core i5 - 12400 AMD Ryzen 5 7500 AMD Ryzen 5 5600	M1 (8-core CPU, 7-core GPU) M2 (8-core CPU, 8-core GPU)
RAM	16 GB		16 GB
Graphics	NVIDIA GeForce RTX 4050 (VRAM 6 GB or higher) NVIDIA GeForce RTX 3060 (VRAM 6 GB or higher) NVIDIA RTX A2000 (VRAM 6 GB or higher) * AMD Radeon is not supported.		-
OS	Windows 10 64-bit Windows 11 (recommended for 12th Gen or later Intel Core processors)		Monterey 12 Ventura 13

Note

Medit i500 is not supported on macOS.

Installation of Medit Scan for Clinics

Installation

Medit Scan for Clinics is installed as a package with Medit Scan for Labs when you install Medit Link.

Please refer to Medit Link > Installation > Installation on Windows or Installation on macOS for installation instructions.

Caution

The scanner may not function properly if you do not restart your PC after installation.

Updates

Software Update

When you run Medit Link, the program checks for updates. The latest version is automatically updated if you have an internet connection.

Medit Scan for Clinics and Medit Scan for Labs are updated to the latest version when a new Medit Link is installed.

Firmware Update

We recommend you keep the firmware version of your wireless hub up to date to utilize new features and improvements. You can still use the existing functions even if you do not immediately proceed with the firmware update.

The program automatically installs the latest firmware when a new update is available as follows:

- ① If you are using a wireless scanner, connect the wireless hub and the PC with a cable and check if your scanner is connected to the wireless hub. Connect the wireless hub and the PC with a cable.
- ② Run Medit Scan for Clinics.

- ③ The following dialog appears when new firmware is available.

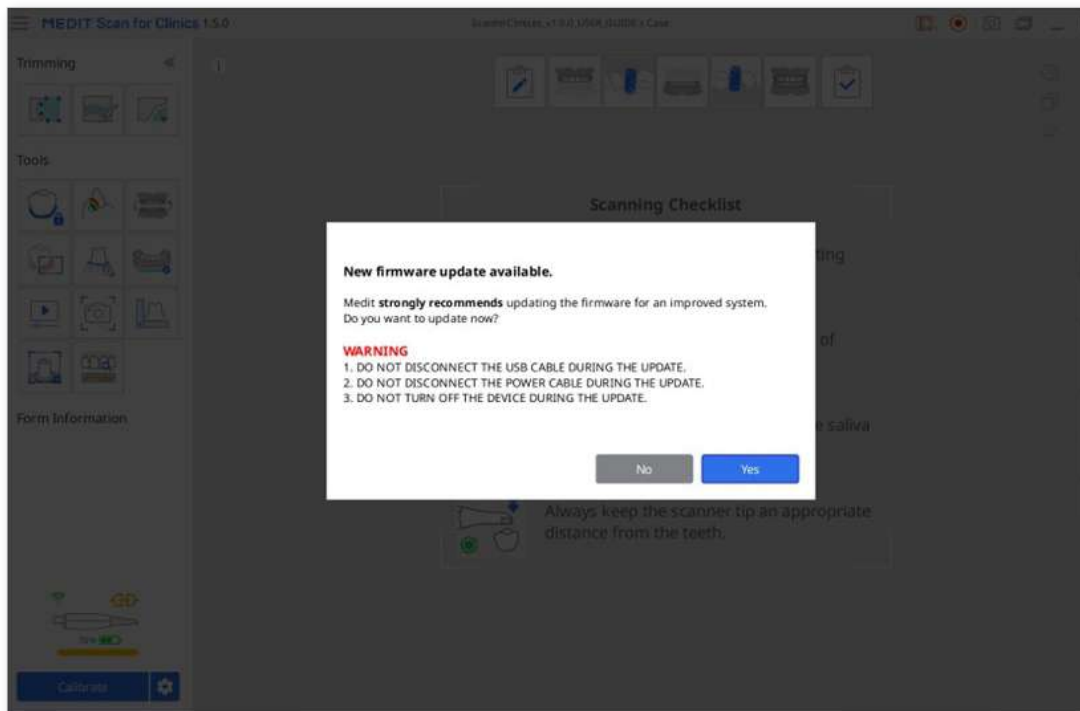

- ④ Click "Yes" to continue firmware updating.

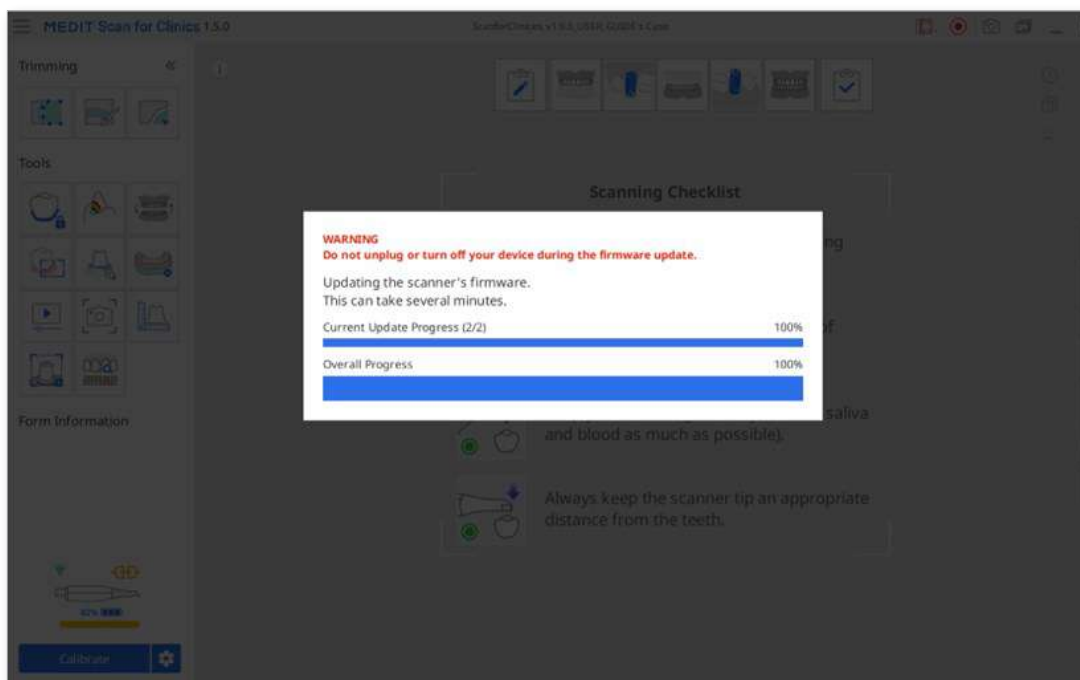

- ⑤ When the firmware is updated, the hub will try to connect the scanner again.

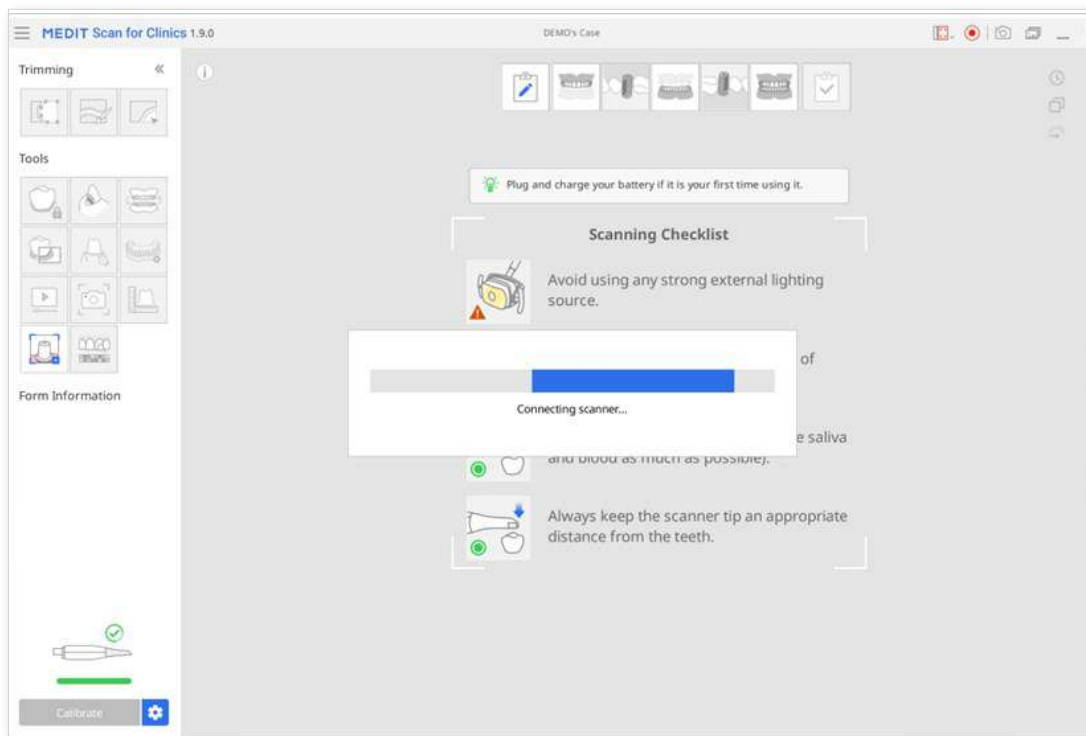

- ⑥ You can check your current firmware version on Menu > About > Firmware Version.

Note

The update can be stopped if the hub is disconnected from the local PC or the scanner has a low battery.

In this case, you can update firmware by reconnecting the hub to the PC and rerunning the program.

Scanner Connection

When you run Medit Scan for Clinics, you can check the scanner and wireless hub status at the bottom left corner of the screen.

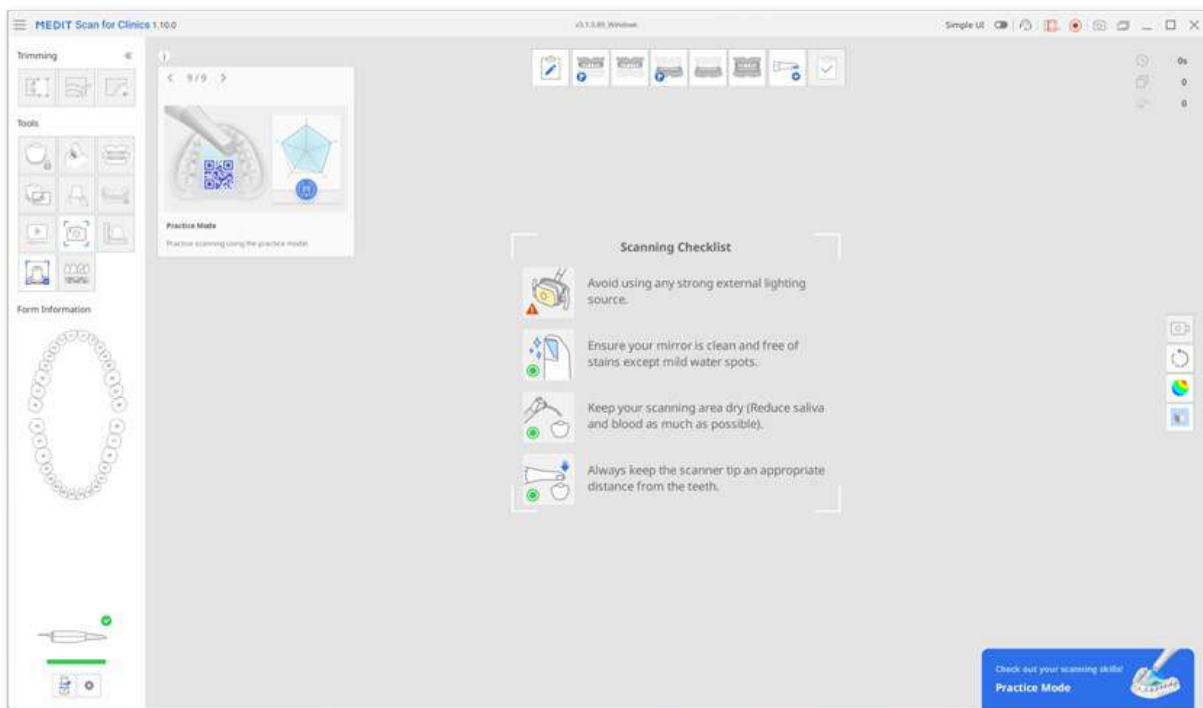

Scanner Status

The following are indications of the scanner status:

Status	Description	i500	i600	i700	i700	i900
Not Connected	The scanner is not connected.					
No Tip	The tip is not mounted.	N/A				
Connecting	The scanner is trying to connect.					
Rebooting	The scanner is rebooting.					
Calibration Required	The scanner needs to be calibrated.					

Ready	The scanner is ready for use.					
Scanning	The scanner is currently in the process of scanning.					
Sleep	The scanner is in sleep mode.		N/A	N/A		
Overheating	The scanner is overheated.					

Hub Status

When you use a wireless scanner, the status of the wireless hub is displayed as shown below:

Hub Connected	The hub is connected to a scanner.	
Connecting	The hub is connecting to the pc.	
Overheating	The hub is disconnected from a scanner.	

Pairing Manager

Note

This feature is available only for the i700 wireless.

- 1 Connect a wireless hub for i700 wireless and the following icon appears below the scanner status image.

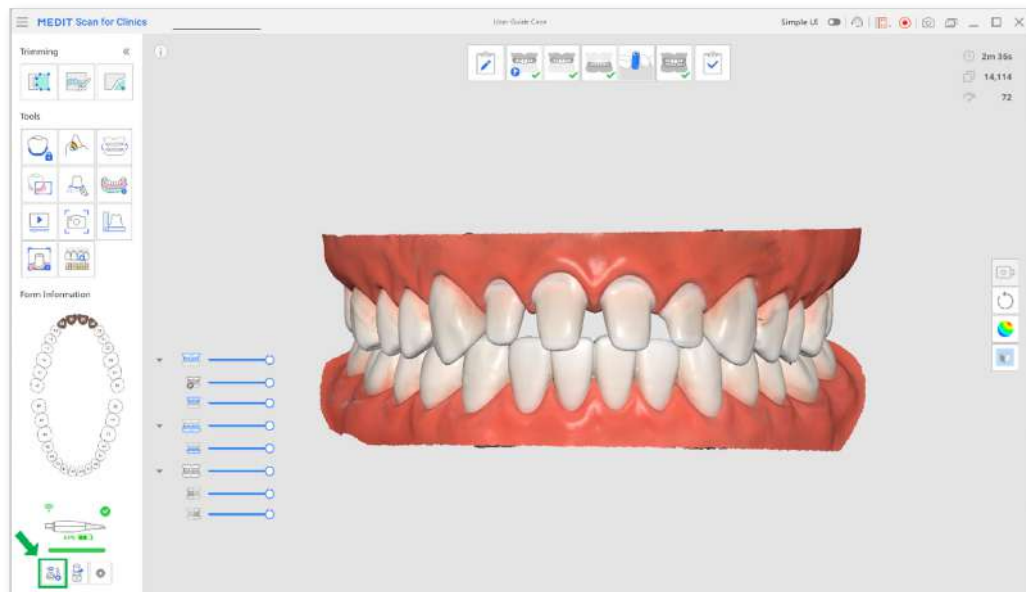

- 2 Click the "Pairing Manager" icon to show the following options.

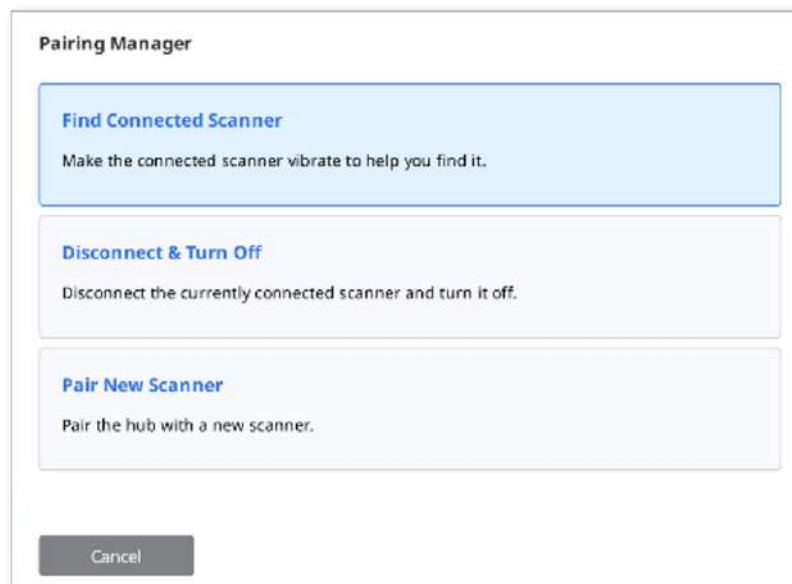

Find Connected Scanner	Make the paired scanner vibrate to help you find it.
Disconnect & Turn Off	Disconnect the currently paired scanner and turn it off.
Pair New Scanner	Pair the wireless hub with a new scanner.

- ③ Select the "Pair New Scanner" option.
- ④ Turn on the scanner and click "Next."

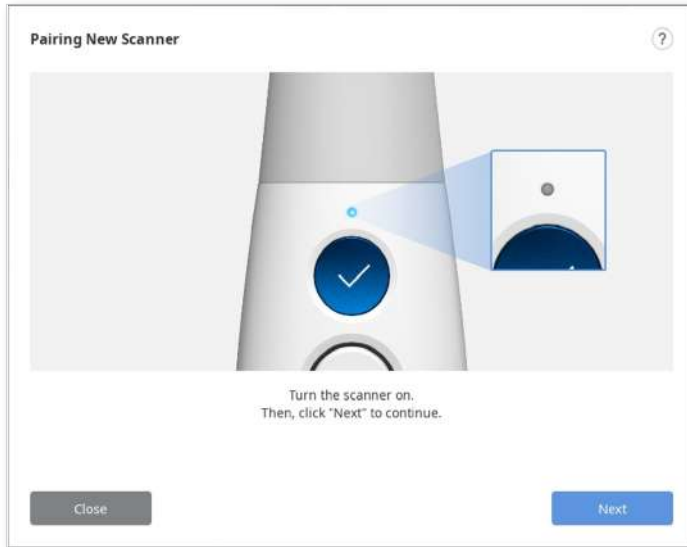

- ⑤ First, hold down the scanner's Control button, then press the Scan button at the same time. When the scanner's LED blinks quickly, release your finger from both buttons. Click the Pair button on the screen. The scanner starts to pair with the hub.

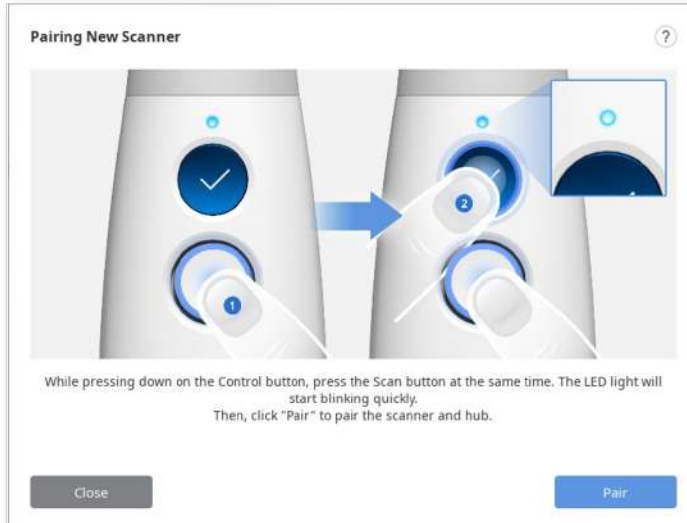

- ⑥ Try not to disturb the communication between the scanner and the hub while trying to pair. Be sure not to remove the scanner battery or disconnect the hub from your PC.

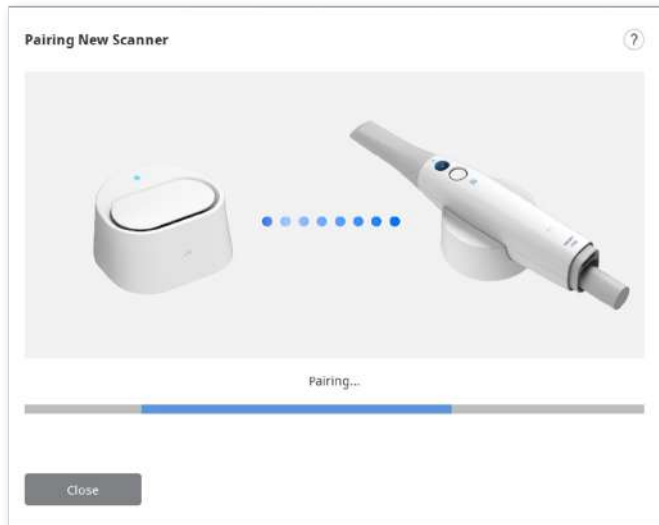

- ⑦ Click "Complete" when the "Pairing successful!" message appears.

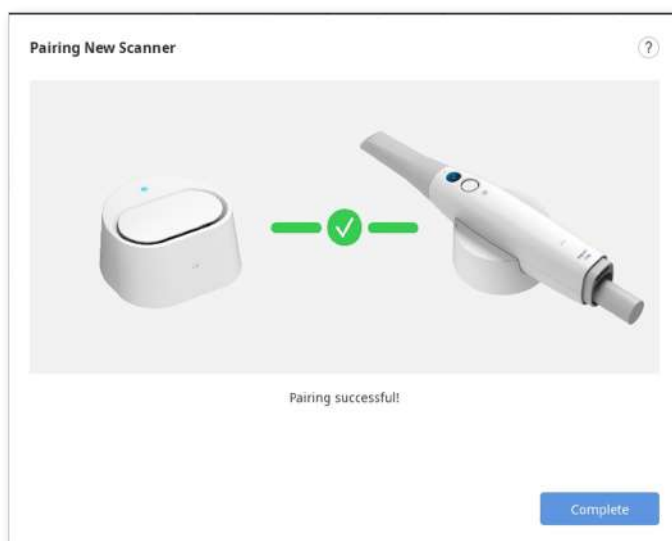

- ⑧ Check the scanner status at the bottom left.

⚠ Caution

You may see the failure message when the connection is unstable, or the scanner fails to pair with the hub. Then restart manual pairing from the beginning.

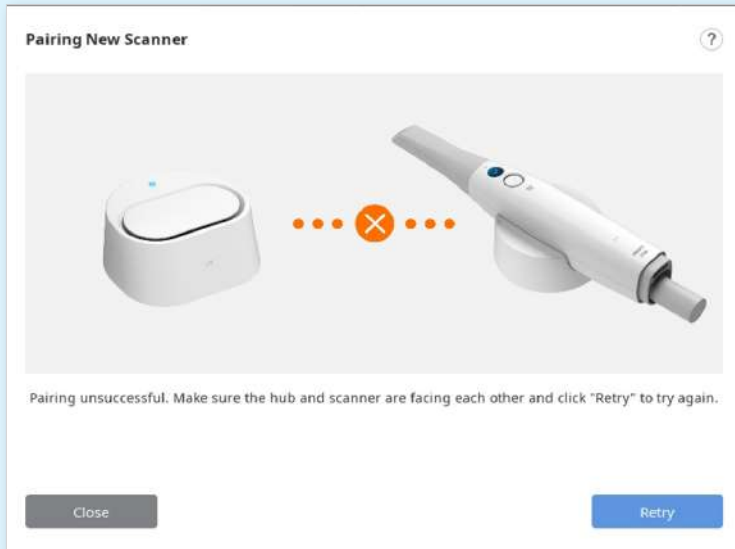

Switch & Scan

Switch & Scan is to register a single scanner to two or more wireless hubs and switch connections between hubs. This feature allows you to carry a scanner from room to room and connect to any wireless hub in your clinic.

First, you need to register the device information of your scanner and wireless hub by manual pairing. Unregistered scanners and wireless hubs cannot connect with each other, no matter how strong the connection signal is.

Note

This feature is available only for the i700 wireless.

1. Make sure your firmware is up to date before using the Switch & Scan feature.
2. If you connect with a new hub that has never connected to your scanner, manual pairing is required to register the scanner to the new hub.
3. Make sure both your scanner and the hub to connect with are turned on. You can connect the scanner and the wireless hub without running the Medit Scan for Clinics.
4. Press the center of the Control button for more than two seconds.
5. The scanner will vibrate briefly three times. That means you are ready to use Switch & Scan.
6. The scanner generates a short vibration when successfully connected to a wireless hub.
7. Run the program and start scanning.

Caution

- If you have multiple wireless hubs in an unclosed workspace, the scanner may be connected to a hub other than the one you want to connect to.
- If you try to connect between two wireless hubs, the scanner may be connected to a hub other than the one you want to connect to.
- If the scanner fails to connect, get closer to the wireless hub you want to connect to and try again to connect by pressing the center of the Control button for more than two seconds.

Scanner Calibration

Intra Oral Scanner Calibration

Note

It is recommended to calibrate the device periodically.

Go to Menu > Settings > Scanner, and configure the calibration period in Calibration Period (Days) option.

Calibration is recommended for proper scanning and performance of the device.

Please calibrate the scanner when:

- The quality of scan data has decreased as compared to the previous scans.
- The external conditions, such as device temperature, changed during use.
- It is already past the configured calibration period.

Caution

The calibration panel is a delicate component. Please do not touch it.

If the calibration fails, inspect the panel and contact the service provider if it is contaminated.

Please note that the accuracy of scan data increases if the temperature of the scanner during calibration is similar to that of while scanning.

Let your scanner warm up before calibration to reach the same temperature to the same temperature as during scanning.

How to Calibrate (i500, i600, i700, i700 wireless)

The following describes how to calibrate based on the i700. Other Medit intraoral scanners, except for the i900, can be calibrated in the same way. For i900, please refer to [How to Calibrate \(i900\)](#).

Note

The user can select "Next" or "Complete" by pressing the Scan button on the scanner.

- ① Turn on the scanner and connect the scanner to the software.
- ② Click the "Calibrate" icon at the bottom left corner of the program.

Note

You can just insert the scanner into the calibration tool to start calibration.
(unavailable with i500)



- ③ Prepare the calibration tool and click "Next" to start the calibration process.

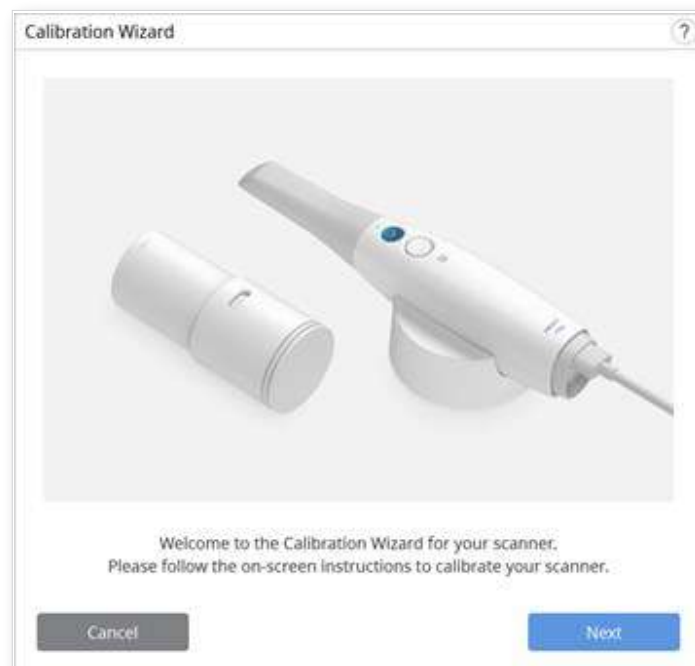

- ④ Set the dial of the calibration tool to position 1.

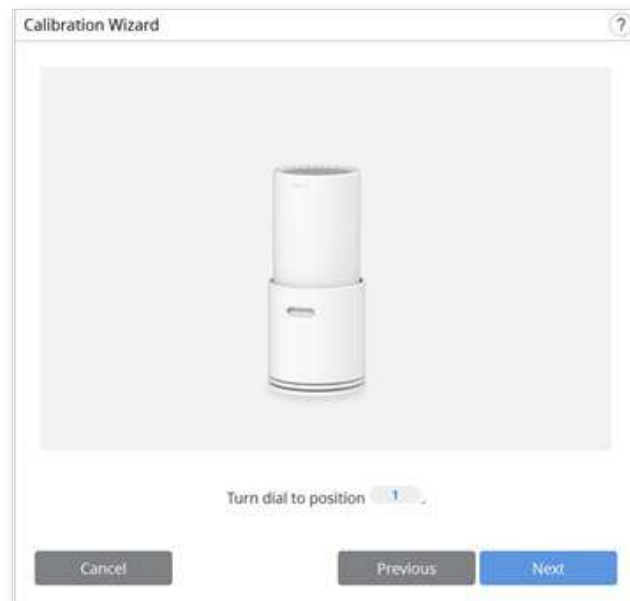

- ⑤ Insert the handpiece into the calibration tool.

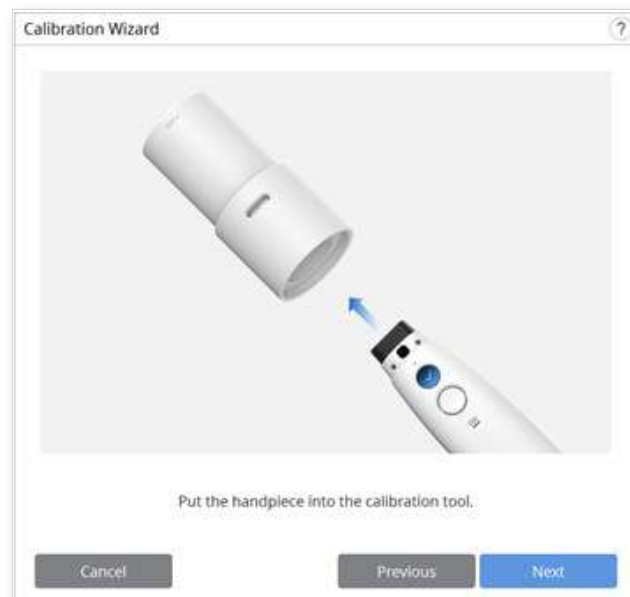

- ⑥ Click "Next" to start the calibration.

- ⑦ If the scanner's temperature is too low, pre-heating will be required to provide the best performance.

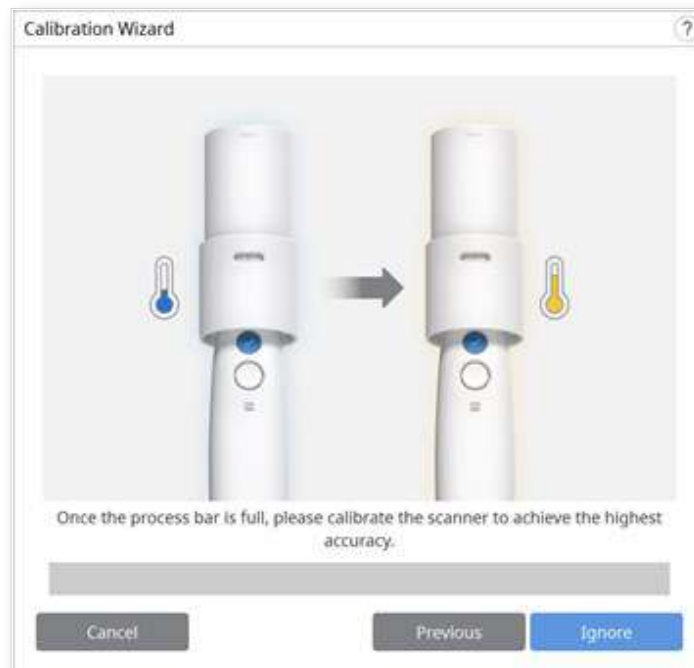

- ⑧ If the handpiece is mounted correctly, the system will automatically acquire the data at the correct position 1.

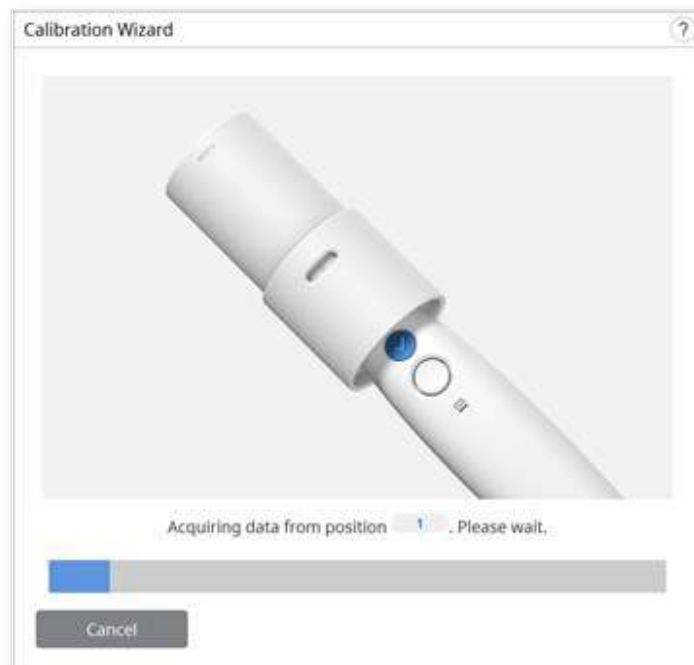

- ⑨ After completing data acquisition at position 1, turn the dial to the next position according to on-screen instructions.



- ⑩ Repeat the above process for positions 2 to 8 and the LAST.
- ⑪ After data acquisition at the LAST position completed, the calibration result will be displayed.

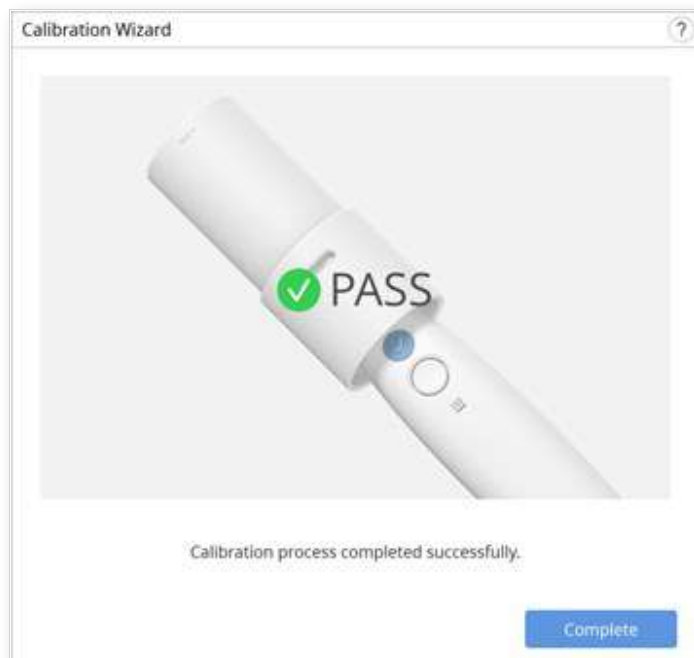

How to Calibrate (i900)

The following describes how to calibrate based on the i900. Please refer to [How to Calibrate \(i500, i600, i700, i700 wireless\)](#) for other scanners.

Note

The user can select "Next" or "Complete" by long-tapping on the Menu Button.

- ① Turn on the scanner and connect the scanner to the software.
- ② Click the "Calibrate" icon at the bottom left corner of the program to run the Calibration Wizard.

Note

You can just insert the scanner into the calibration tool to start calibration.



- ③ Prepare the calibration tool and click "Next" to start the calibration process.

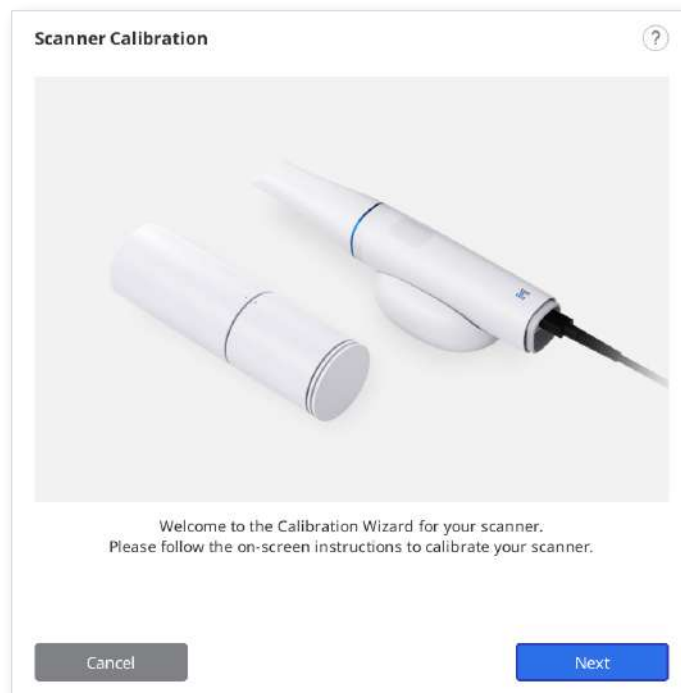

- ④ Set the dial of the calibration tool to the starting position.

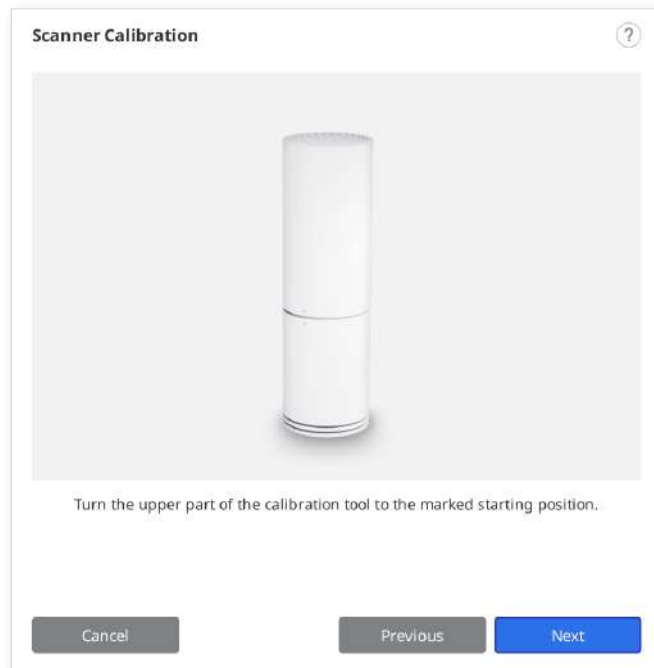

- ⑤ Insert the handpiece into the calibration tool.

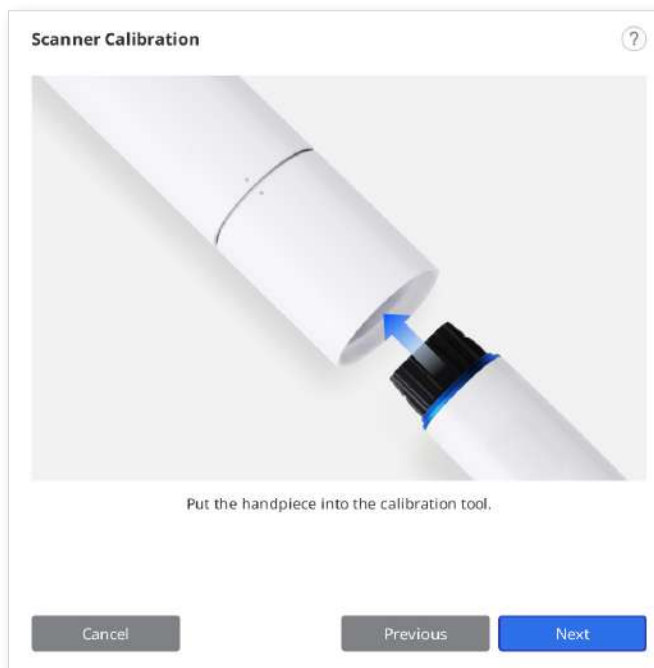

- ⑥ Click "Next" to start the calibration.

- ⑦ If the scanner's temperature is too low, pre-heating will be required to provide the best performance.

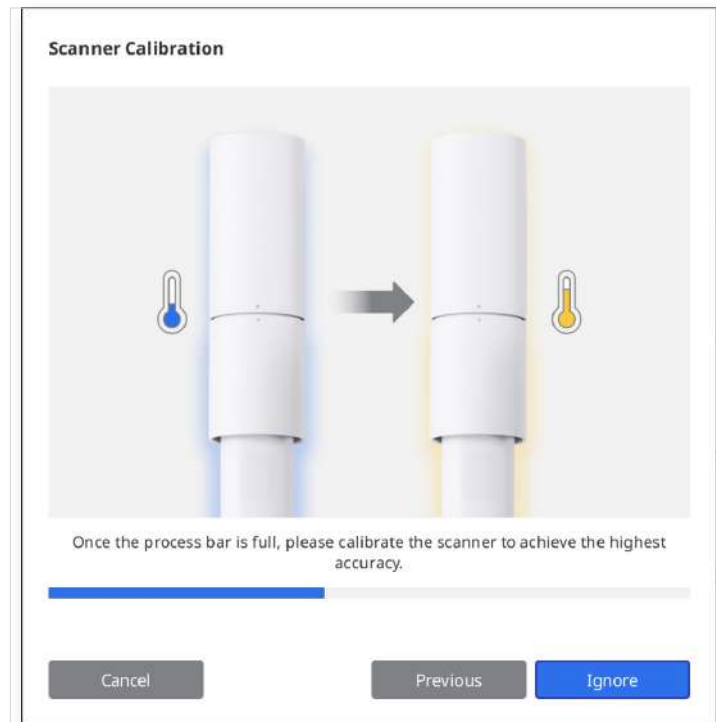

- ⑧ If the handpiece is mounted correctly, the system will automatically acquire the data.

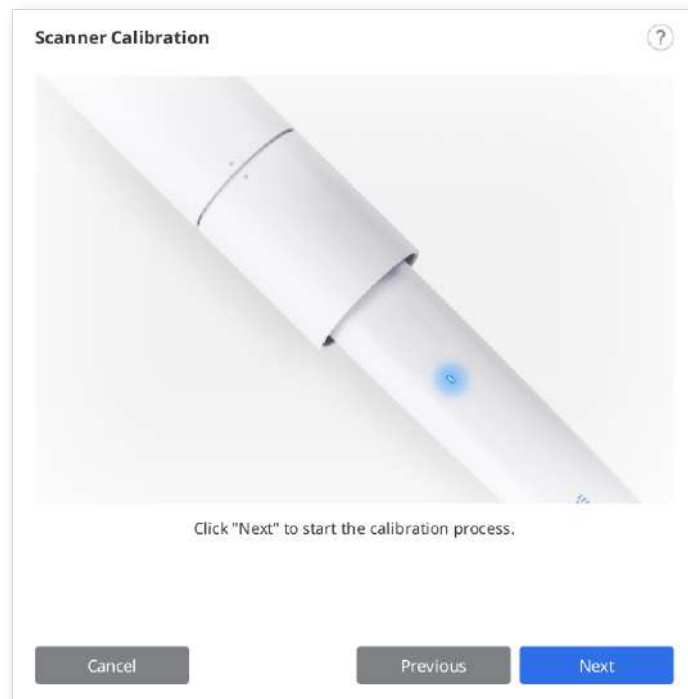

- ⑨ After completing data acquisition at the starting position, turn the calibration tool to the next position according to on-screen instructions.

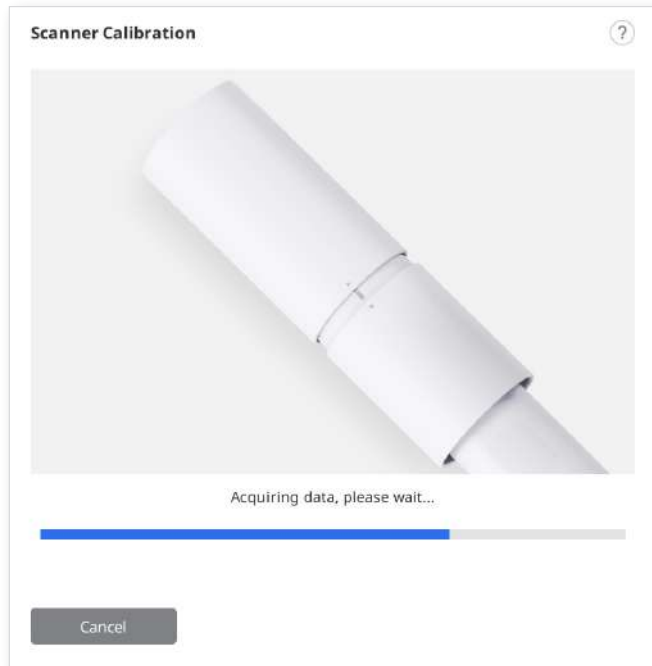

- ⑩ Repeat the above process to the last position.
- ⑪ After data acquisition at the last position is completed, the calibration result will be displayed.

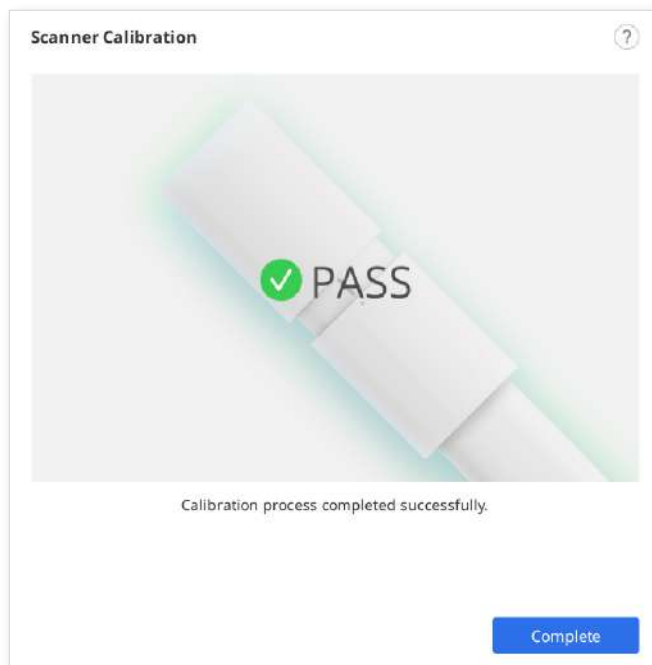

Getting Started

User Interface

Overview

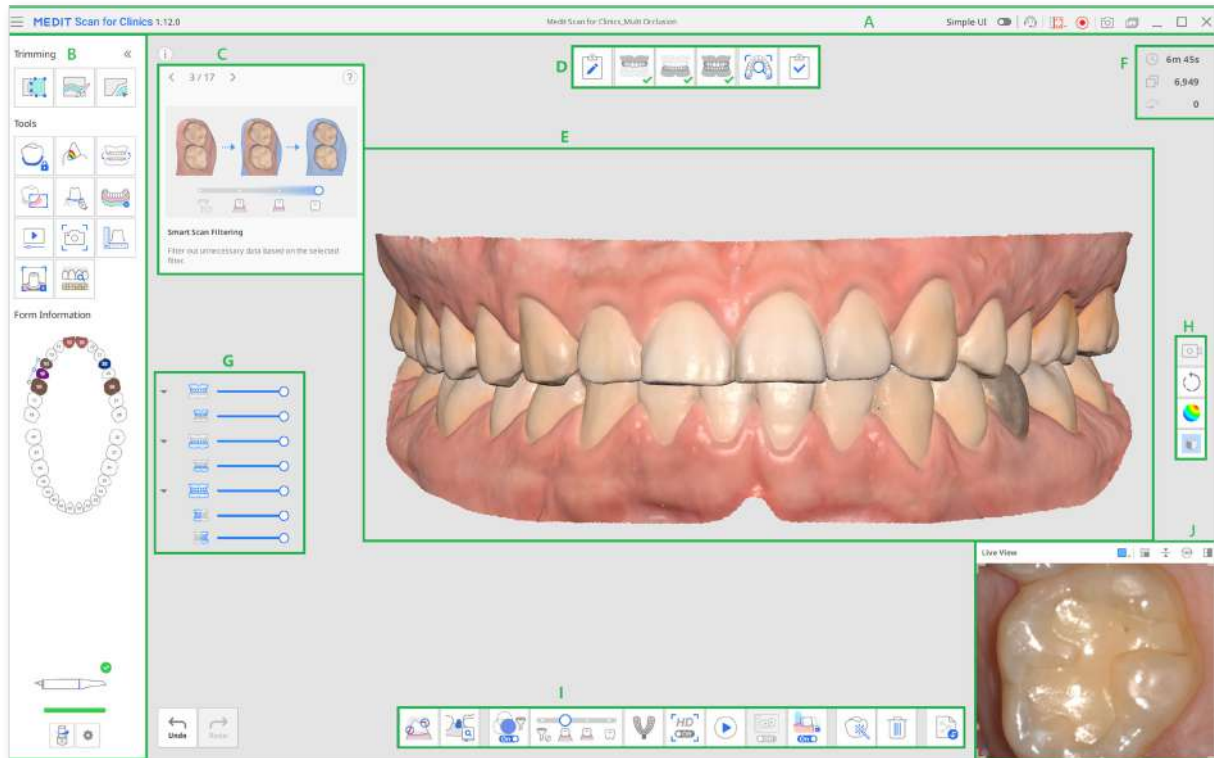







A	Title Bar	F	Scan Information
B	Main Toolbar	G	Data Tree
C	Information Box	H	Side Toolbar
D	Stages (Workflow)	I	Scan Stage Toolbar
E	Model View	J	Live View

Note





The title bar may look different on macOS, and the image can appear in different sizes according to the screen resolution.

Title Bar

The title bar consists of the following options.

	Menu	Provide basic program functions such as Save, Settings, User Guide, and About.
	Simple UI	A toggle button to switch to the simple user interface.
	Submit Support Request	Land on a Medit Help Center page to submit a support request.
	Select Video Record Area	Select which area of the screen to record the video. The user can record the entire window of the program or only the area where 3D data is displayed.
	Start/ Stop Video Recording	Start or stop video capturing. The captured video file can assist in communication between the patient, clinic, and laboratory.
	Screenshot	Capture the entire screen or only the 3D data display area of the scanning software. The captured image file can assist in communication between the patient, clinic, and laboratory.
	Screen Capture Image Manager	Manage captured images. Screenshots are automatically saved to Medit Link. The user can delete or save them to the local PC in JPG, JEP, PNG, and BMP format.

Clicking the "Menu" icon will show the following options:

	Save	Save all changes in the current case.
	Settings	See options for setting environment, such as scan options
	User Guide	Open the user guide.
	About	See application details, version number, and copyright information.

Main Toolbar

Please refer to Main Toolbar Tools for information on how to use the tools in the Main Toolbar.

Form Information

Form Information registered from Medit Link provides an overview of the teeth that need treatment.

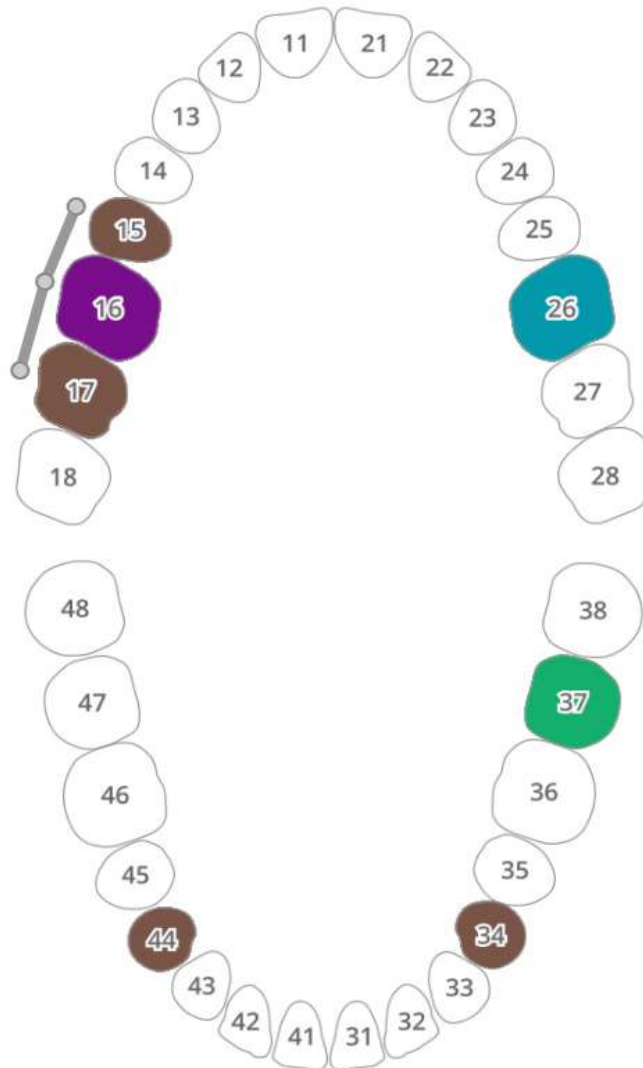

Info Box

Scanning and editing processes are accompanied by short explanations and visual aids to explain major functions and introduce the tools that can be useful at this stage.

For general scan stages, the information is displayed randomly to expose users to various functions.

For general scan stages, the information is displayed randomly to expose users to various functions.



Scan Stages



Please refer to [Stage Management](#) for more information about how to set the scanning workflow.

Model View

The scan data corresponding to the selected stage in the case is shown in the 3D data display area. You can also view the data acquired in the area in real time while scanning.

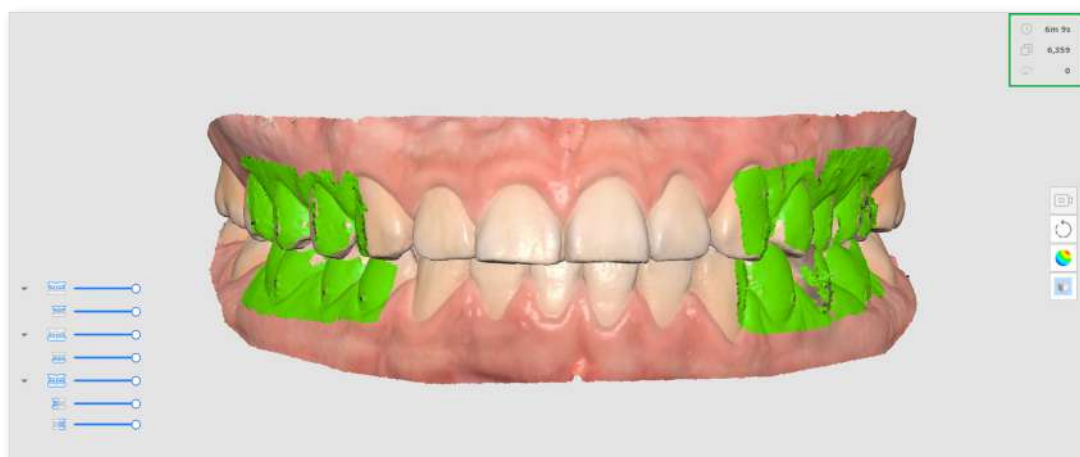
Scan Information



	Scan Time	Show the time taken to scan for each scan stage and all scan stages.
	Number of Frames	Show the number of images taken during scanning for each scan stage and all scan stages.
	Scan Speed	Show the current scan speed.

Data Tree

The data tree at the overview stage allows controlling the data display options.

- Right-click on the data tree to show the following options:

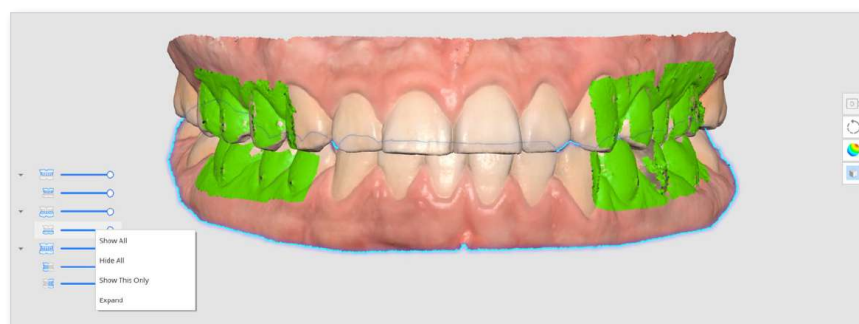

- Show All
 - Hide All
 - Show This Only
 - Expand/Collapse
- Use the slider to control the opacity of each data.
 - Hovering over the icon of each data will highlight the corresponding area. You can differentiate and examine the data you want to inspect.

Side Toolbar

Please refer to [Side Toolbar Tools](#) for more information about tools on the Side Toolbar.

Scan Stage Toolbar





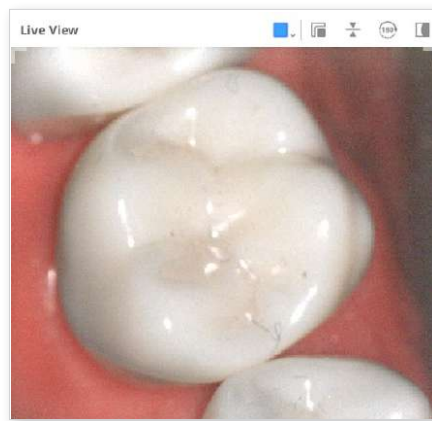

Please refer to [Scan Stage Tools](#) for more information about using tools that appear at the bottom of the screen for each stage.

Live View

The Live View window displays the 2D image obtained from the scanner and provides useful tools.



The following tools are provided on the title bar of the Live View window:

	Custom Scan Area	Adjust the area to acquire scan data. You can choose between the modes we provide or adjust as you want.
	Detach Live View Window	Detach the Live View window from the fixed position. The window size can be changed when the window is detached.
	Reset Live View Window	Bring the Live View window to the default position and size.
	Flip Image	Flip scan data upside down. This is useful when performing intraoral scanning from the top of the patient's head.
	Rotate 180°	Rotate the scan data by 180 degrees to match the direction of the teeth data on the screen to your viewpoint of the patient's teeth.
	Show/Hide Masking	Turn on or off the visibility of the unscannable area. The unscannable area is shown with blue masking.

Clicking the "Custom Scan Area" icon shows the following options to set the Live View window size:

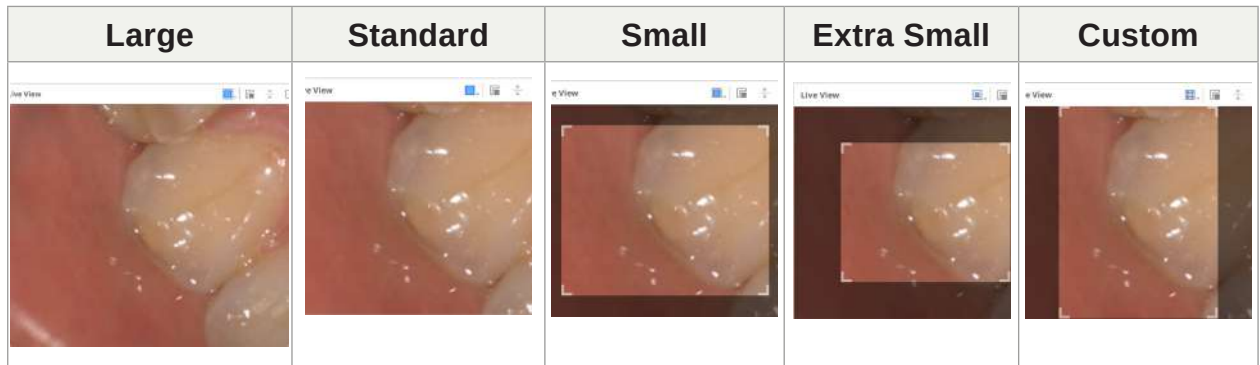

Clicking the "Show/Hide Masking" icon will show or hide the unscannable area as follows:

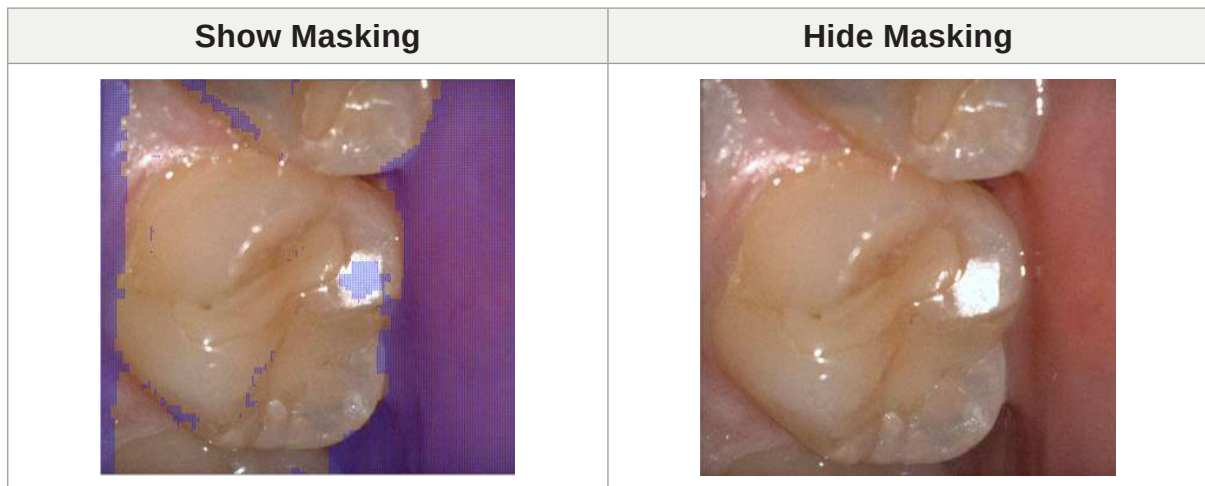

Scan Depth

The scan depth can be adjusted as follows according to the scanner type:

- i500: 12(mm)-21(mm)
- i600, i700, i700 wireless, i900: 12(mm)-23(mm)

A deeper scan depth can be applied to almost all general scanning works. A shallow scan depth is useful when filtering out noisy data, such as unnecessary soft tissues.

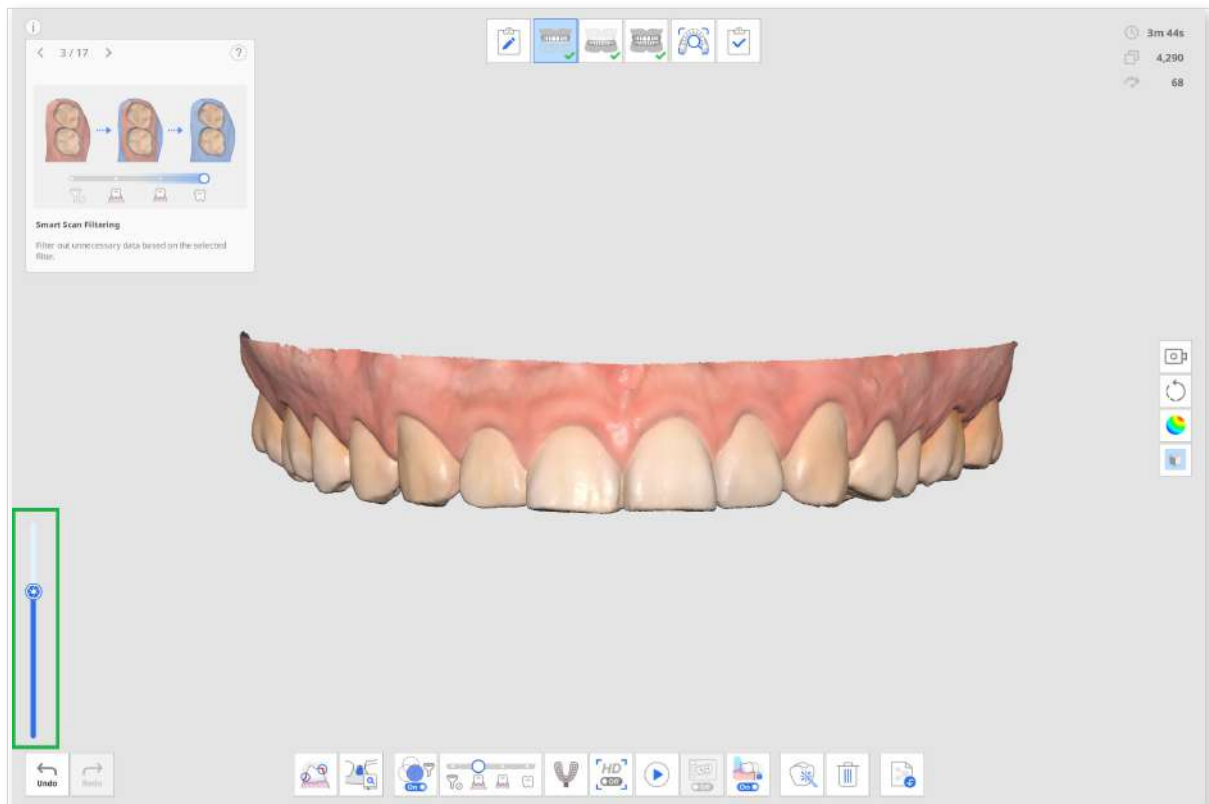

Settings

Go to Menu > Settings to open the Settings dialog for Medit Scan for Clinics.

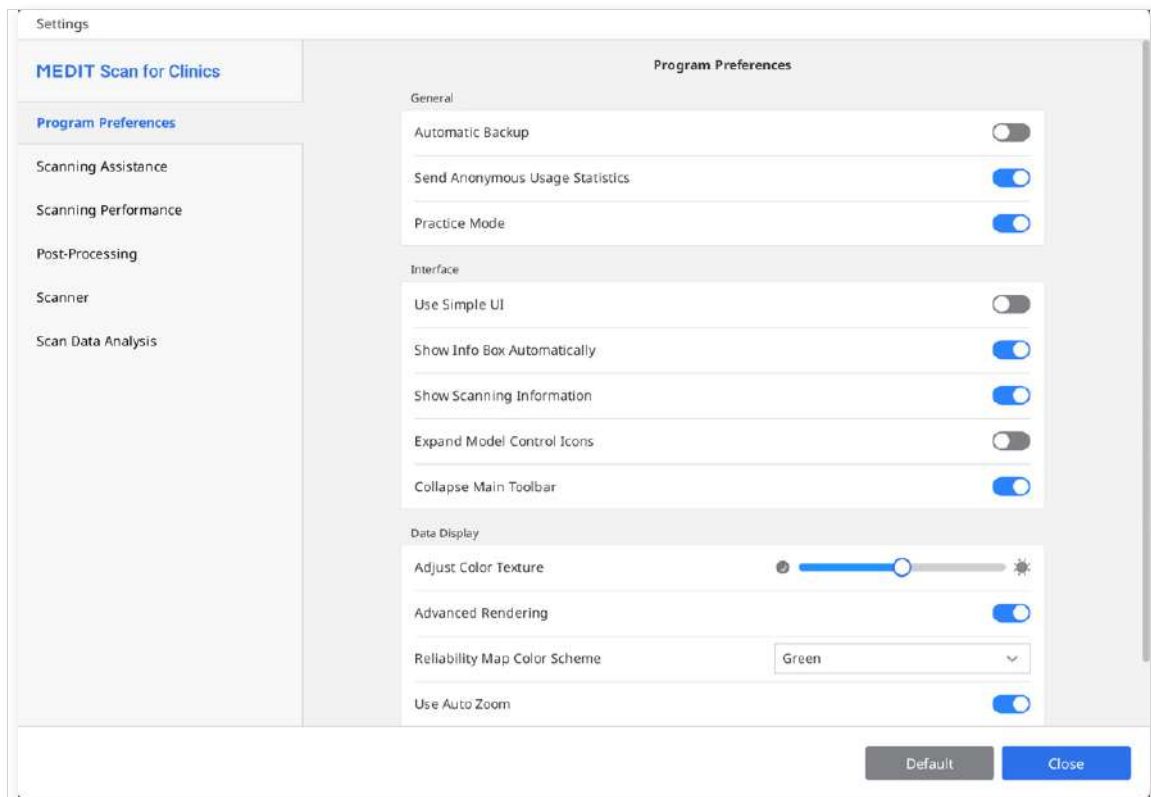

Note

When you click the "Default" button, all configured parameters will be reset to their default values.

Program Preferences

General

Automatic Backup	Save the current work temporarily. Backup data will be used for recovery if the program stops unexpectedly without saving.
Send Anonymous Usage Statistics	<p>Set whether to send anonymous usage statistics to Medit.</p> <p>Collecting Anonymous Statistics</p> <p>Medit is striving to constantly improve the product and user experience by collecting certain information such as:</p> <ul style="list-style-type: none"> • Hardware and software configurations, such as OS, graphics card, etc. • Patterns and trends in how our software is used, such as frequency and performance. • Diagnostic information. <p>The usage statistics will help the development team better understand user requirements and make improvements in future releases. We will never collect personal information, such as your name, company name, MAC address, or any other information related to personal identification. We cannot and will not reverse-engineer any collected data to find specific details concerning your projects.</p>
Practice Mode	<p>Provide scanning training for users using a practice model. When this option is enabled, the "Practice Mode" banner is displayed on the full screen when there is no acquired scan data.</p> <p>* Unavailable with i500</p>

Interface

Use Simple UI	When on, the program switches from the default interface to the simple interface. The simple interface provides minimum features to acquire and process scan data.	
Show Info Box Automatically	When on, the program automatically shows the information box in the top left corner of the window while working with the program.	
Show Scanning Information	Scan Time	Display the scan time for each stage or the total scan time.
	Number of Frames	Display the number of images taken by the scanner for each stage or the total number.
	Scan Speed	Display the current scan speed.

Expand Model Control Icons	When on, the 3D model control icons of panning, rotating, zooming, and zoom fit are added to the side toolbar.
----------------------------	--

Data Display

Adjust Color Texture	Adjust the brightness of the 3D model. The color of the 3D model will be optimized for the image acquisition software. When viewing data using other software, the resulting colors may be slightly different from the image acquisition software.
Advanced Rendering	Display vivid 3D data with advanced technology applied.
Reliability Map Color Scheme	Set the color of reliable data between Green, Blue, and Green/Yellow.
Use Auto Zoom	When on, the zoom magnification is automatically set according to the size of the current scan data.
Zoom Magnification	Set the zoom magnification manually when the "Use Auto Zoom" is disabled.

Scanning Assistance

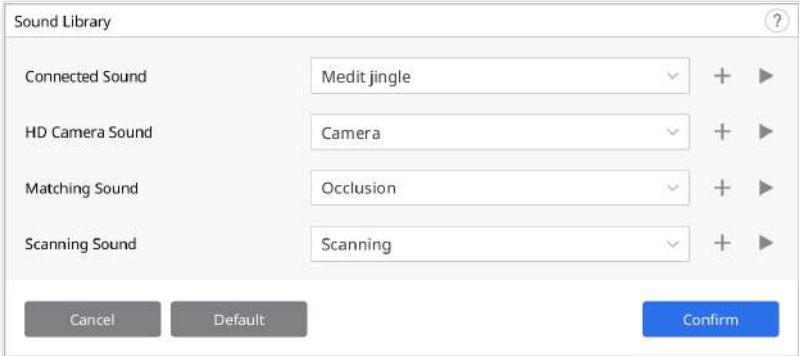
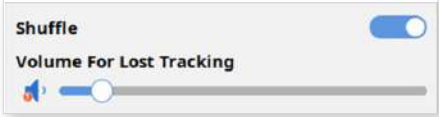
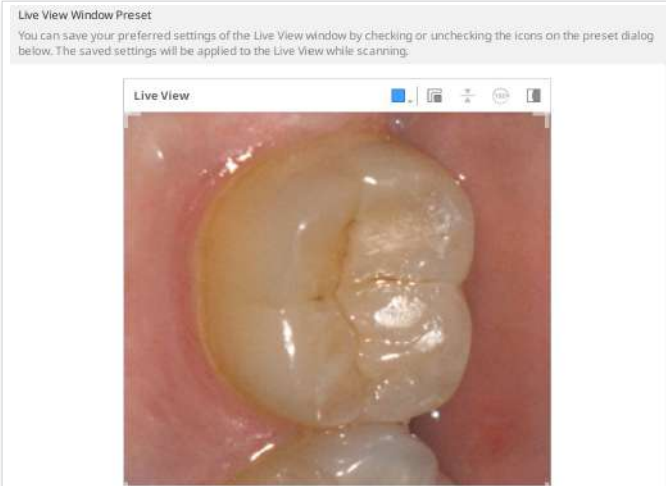

Smart Scan Guide	Identify any unusual actions during the scanning and provide relevant guidance.
Smart Arrow	Show blue arrows to demonstrate areas with low reliability based on the gathered scan data.
Warning for External Light (Beta)	Display a warning when an external light source affects the scan. * Unavailable with i900
Warning for Occlusal Data	When the user clicks "Complete" after scanning the data, the program checks the data and its alignment status acquired during the occlusion scan stage.
Enable Audio Feedback	Indicate the status of the scanner through different sounds.

<p>Sound Library</p>	<p>Select the sound file for audio feedback indicating the device status. Audio files in various formats, including .wav, .mp3, and .wma, can be added to the sound list.</p>  <p>For the scanning sound, additional options such as "Shuffle" and "Volume For Lost Tracking" are provided.</p> 
<p>Live View Image Stabilization</p>	<p>When on, automatic image stabilization is applied in the Live View during scanning to provide users with stabilized images with improved clarity and stability.</p> <p>* i900 only</p>
<p>Live View Window Preset</p>	<p>Define the default settings for the Live View window options, such as window size, detach/reset window, and show/hide masking.</p> <p>Once you change the settings in the preset window, the changes are applied to the Live View window that appears while you are acquiring the scan data.</p> 

Scanning Performance

Use GPU	Utilize this option to Improve overall computing performance using the GPU (graphics processing unit).
Prevent Scan Data Misalignment	Align scan data using additional information when acquiring scan data with the Smart Scan Filtering option on.
Extend Dynamic Range	Use peripheral data to assist in scanning difficult-to-scan areas.
Smart Stitching Interval	<p>Adjusts the interval to acquire new scan data for Smart Stitching.</p>  <p>When the Smart Stitching feature is on, you can acquire and save non-continuous areas as separate data, and the continuous areas will later be aligned as you acquire more data in between.</p> <p>A shorter smart stitching interval will start scanning for discontinuous data sooner. At the same time, a longer smart stitching interval will wait a bit longer for the user to acquire contiguous data before accepting discontinuous data.</p>
Use Glitch Filtering in Live View (Beta)	<p>Filter glitching image acquired while scanning. The results can be affected by the strength of the scanner connection signal.</p> <p>* i700w only</p>
Global Soft Tissue Filtering	Delete soft tissue and noise data. Global soft tissue filtering is conducted during scanning, when you move to another scan stage, and when you complete.
Active Noise Filtering (Beta)	Effectively remove noisy data acquired during scanning.
Prevent Occlusion Misalignment (Beta)	Check the direction of occlusion and mandibular data to prevent misalignment while acquiring occlusion data.
Metal Scan	Turn this option on to automatically apply parameters optimized for metal scans when metal prostheses, such as crowns, occupy more than a certain amount of scan area.

Post-Processing

Set File Size Automatically	Turn this option on to apply optimal file size for the scan data automatically.
File Size	<p>Adjust the size of the result file.</p>  <p>Setting the slider bar to the left makes the calculation faster and produces a smaller output.</p> <p>Users can determine the file size based on the intended use of the result file. Smaller result files are suitable for orthodontic cases.</p>
Optimize Occlusion Alignment	<p>When on, the program optimizes the occlusion alignment data.</p>  <p>Set the slider bar to the left to loosen the bite alignment of the maxilla and mandible, while setting the slider bar to the right tightens the bite alignment of the maxilla and mandible.</p>
Use Neighboring Colors for Filled Holes	Turn this option on if you want to fill in the empty spaces in scan data with the color of the adjacent data.
Clean Out Data Layering (Beta)	Identify and remove double-layering or multiple-layering areas automatically while optimizing scan data.
Use Background Processing	Process data in the background for stages where no data is acquired or manipulated.
Optimize After Occlusion Alignment	Automatically optimize the maxillary and mandibular data when occlusion alignment is complete. The optimized occlusal relationships allow you to preview the occlusal state of the final result data.
Optimize Scan Data Automatically	Optimize automatically during the process of obtaining scan data.

High-Resolution Data Processing

Apply to	Both SD and HD Scan Data	Apply high-resolution data processing to all the SD and HD scan data if HD data exists.
	HD Scan Data Only	Apply high-resolution data processing to HD data only.

<p>Apply to Prepared Teeth Data (Beta)</p>	<p>Turn this option on to let the program automatically detect the prepared teeth data and apply high-resolution data processing to the prepared teeth data.</p> <p>When this option is on, the tooth area for tooth numbers registered from Medit Link can be selected in the Smart Scan Review feature.</p> <p>Also, if margin lines are specified, the teeth with margins are processed as high-resolution data.</p>
--	---

Scanner

<p>Start Automatic Scan</p>	<p>The program automatically starts scanning when you enter the scan stages without you having to perform any actions to start the scan.</p> <p>When this option is off, you can start scanning by pressing the Scan button or, for i900, double-tapping the Touch Band.</p>
<p>Calibration Period (Days)</p>	<p>Set the calibration period of the scanner.</p>
<p>Initiate Scan with HD Scan</p>	<p>Set to start scanning in HD mode by default.</p>
<p>Scan Light</p>	<p>Set whether to use blue light or white light for scan light.</p>
<p>Minimum Scanner Temperature Notification</p>	<p>The scanner temperature is checked when the user starts scanning.</p> <p>If the scanner temperature drops below the minimum value, the scanner begins to preheat.</p> <p>* Unavailable with i500</p>
<p>Turn On UV Automatically</p>	<p>Set to turn on the UV light automatically when the scanner is connected or scanning stops.</p> <p>The UV light will be turned off automatically after the set time for the "UV Operation Time" option or when scanning starts.</p> <p>* Unavailable with i500, i600</p>
<p>UV Operation Time</p>	<p>Set the time duration for the "Turn On UV Automatically" option.</p> <p>* Unavailable with i500</p>

Turn On Vibration Feedback During Scanning	Notify users by vibrating the scanner in case of misalignment, etc. * Unavailable with i500, i600
Anti-Fogging Fan Mode	Select a fan mode between "Silent Mode" and "High-Performance Mode" to remove fogging from the mirror when the scanner temperature is low.
Scanning Experience	Select whether to display the scan data more smoothly or acquire scan data more rapidly. * i700, i700w, i900 only

Scan Button Actions

Double Click	Define the double-click action of the Scan button on the scanner. * Unavailable with i900
Triple Click	Define the triple-click action of the Scan button on the scanner. * Unavailable with i500, i900
Long Click	Define the long-click action of the Scan button on the scanner. * Unavailable with i900

Touch Gestures (i900 only)

Touch Interface Tutorial	Run the Touch Interface Tutorial dialog to practice how to use touch interfaces including Touch Band, Touch Pad, and Menu button.
Touch Band - Swipe Left	Define the swipe left action of the Touch Band on the scanner.
Touch Band - Swipe Right	Define the swipe right action of the Touch Band on the scanner.
Touch Pad - Double Tap	Define the double tap action of the Touch Pad on the scanner.
Menu Button - Long Tap	Define the long tap action of the Menu Button on the scanner.

On Battery Power (i700 wireless only)

Change to Sleep Mode After	The scanner enters sleep mode when not used for the entered number of minutes.
Turn off Scanner After	The scanner is turned off when not used for the entered number of minutes after entering sleep mode.

When Plugged In

Change to Sleep Mode After	The scanner enters sleep mode when not used for the entered number of minutes. * i900 only
Turn off Scanner After	The scanner is turned off when not used for the entered number of minutes when plugged in. * Unavailable with i500

Scan Data Analysis

Smart Scan Review

Enable Smart Scan Review Stage	Turn this option on to show the Smart Scan Review stage in the workflow.
Align with Occlusal Plane When Entering Smart Scan Review Stage	Turn this option on to align the data to the occlusal plane when entering the Smart Scan Review stage before starting the data review.
Check Tooth Reduction Depth for Preparation Review	Turn this option on to check tooth reduction depth when using the Preparation Review feature in the Smart Scan Review stage.
Check Distance to Antagonist for Preparation Review	Turn this option on to check the distance to the antagonist when using the Preparation Review feature in the Smart Scan Review stage.
Check Distance to Adjacent for Preparation Review	Turn this option on to check the distance to the adjacent when using the Preparation Review feature in the Smart Scan Review stage.

Preparation Review

Distances

Set the values below as a criterion to determine if the tooth reduction was done properly. The set values are also used as a reference for Smart Scan Review.

Minimum Distance to Antagonist (mm)	Set the minimum value for distance to the antagonist.
Minimum Distance to Adjacent (mm)	Set the minimum value for distance to the adjacent.

Tooth Reduction Depth

Set the values below as a criterion to determine if the tooth reduction was done properly. The set values are also used as a reference for Smart Scan Review.

Apply Uniform Tooth Reduction	<p>Enable this to apply uniform tooth reduction depth as a reference for all directions.</p> <ul style="list-style-type: none">• When on, the "Minimum Reduction Depth (mm)" will be applied to all directions.• When off, the "Labial/Buccal (mm)," "Palatal/Lingual (mm)," "Interproximal (mm)," and "Occlusal (mm)" will be applied to each direction.
Minimum Reduction Depth (mm)	Set the minimum value for tooth reduction depth for all directions.
Labial/Buccal (mm)	Set the minimum value for the labial/buccal reduction depth.
Palatal/Lingual (mm)	Set the minimum value for the palatal/lingual reduction depth.
Interproximal (mm)	Set the minimum value for the interproximal reduction depth.
Occlusal (mm)	Set the minimum value for the occlusal reduction depth.

Basic Operation

3D Data Control

Medit Scan for Clinics supports three data control modes: Rotate, Pan, and Zoom.

- Zoom

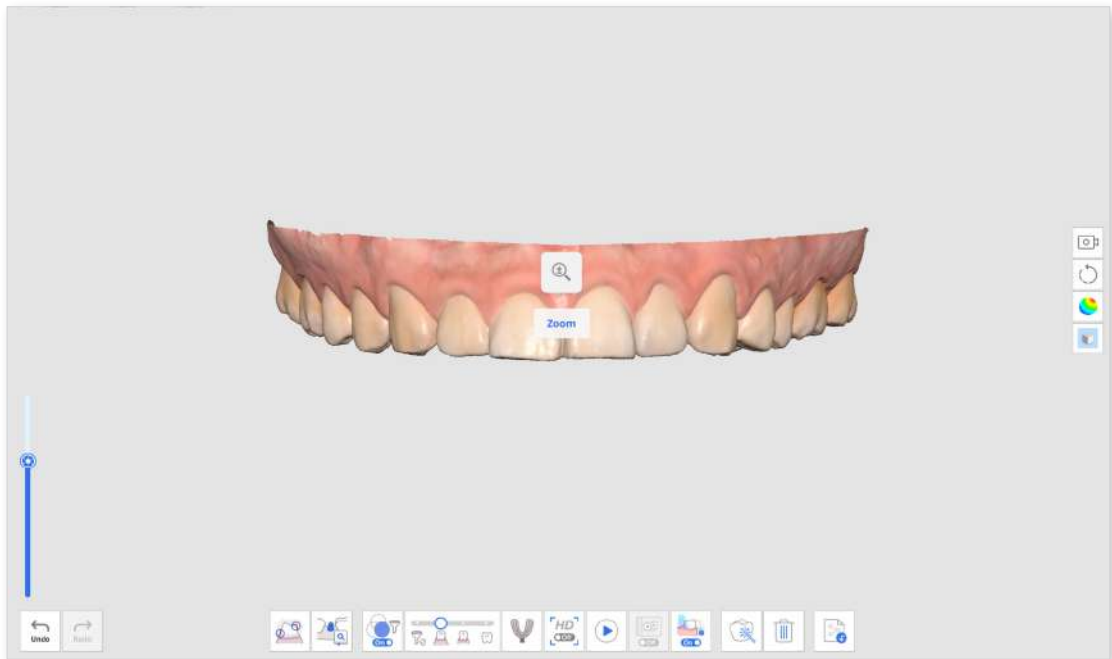

- Rotate

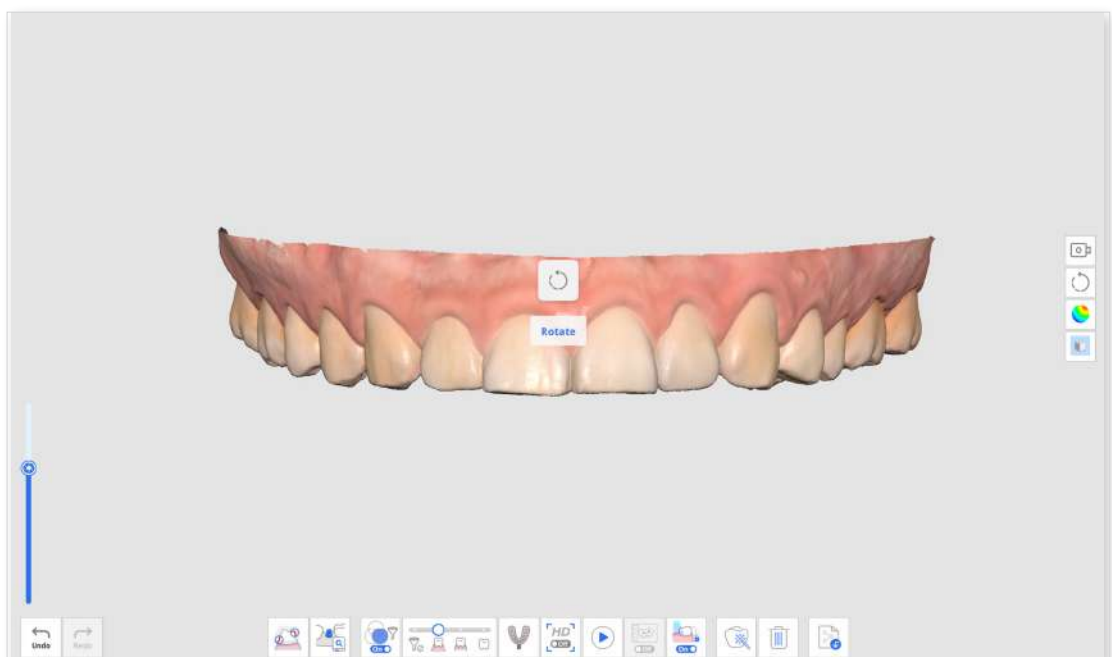



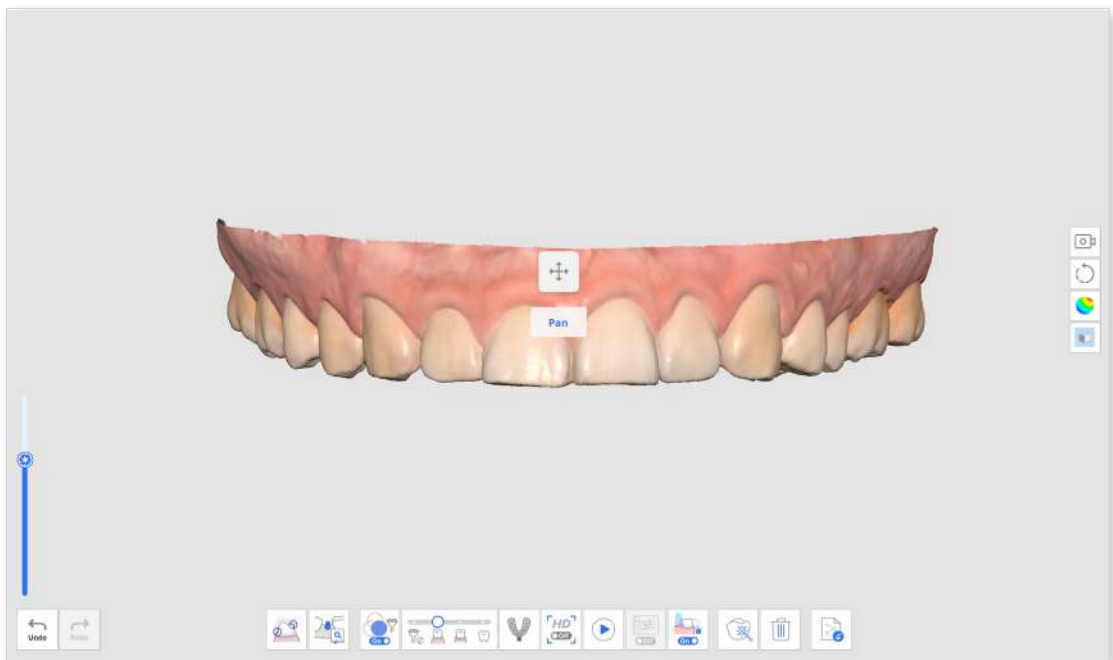

- Pan

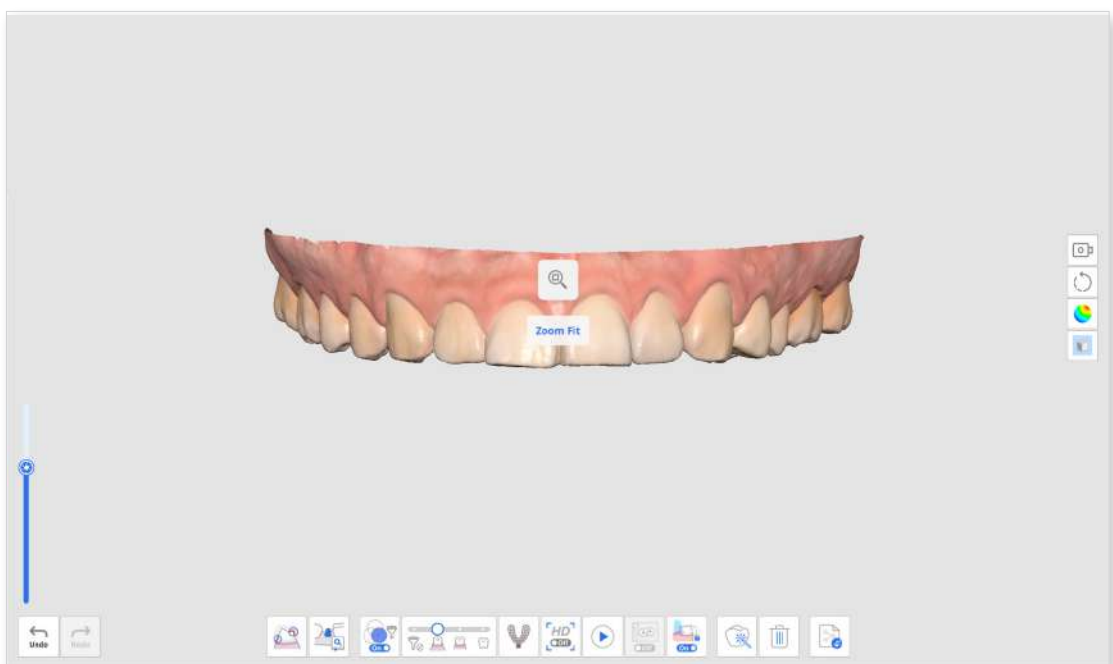



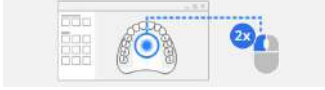









- Zoom Fit: Double-click the Control button to align the data at the center of the screen.



3D Data Control Using a Mouse

	Image	Description
Zoom		Scroll the mouse wheel.
Zoom Focus		Double-click on the data.
Zoom Fit		Double-click on the background.
Rotate		Drag the right button.
Pan		Drag the mouse wheel.

3D Data Control Using Mouse and Keyboard



	Windows		macOS	
Zoom				
Rotate				
Pan				

3D Mouse Support



Medit Scan for Clinics supports using a 3Dconnexion 3D mouse.

3D input device development tools and related technology are provided under license from 3Dconnexion. © 3Dconnexion 1992 - 2013. All rights reserved.

3D Data Control Using Scanner Buttons (i700/i700w)

	Image	Description
Switch Data Control Mode		Single-click on the Control button.
Zoom Fit		Double-click on the Control button.
Zoom		Press up/down on the Control button.
Rotate		Press up/down/left right on the Control button.
Pan		Press up/down/left/right on the Control button.

3D Data Control Using Touch Interfaces (i900)

	Image	Description
Switch Data Control Mode		Short-tap on the Menu Button.
Zoom Fit		Double-tap on the Menu Button.
Zoom		Tap and drag up/down on the Touch Band.
Rotate		Tap and drag up/down/left/right on the Touch Band.
Pan		Tap and drag up/down/left/right on the Touch Band.

Scanning Operation

Start/Stop with Scan Button (unavailable with i900)

You can start or stop the scan by pressing the Scan button on the scanner.



Start/Stop with Touch Band (i900 only)

You can start or stop the scan by double-tapping the touch band on the scanner.



Start/Stop by Lifting/Putting Scanner (i900 only)

You can get ready to scan by just lifting your scanner or stop scanning by putting it on the cradle.

Note

This feature is only available when the “Start Automatic Scan” option is enabled on Settings > Scanner.

Scanning Basics

Scanning Checklist

If no scan data has been acquired yet, the main screen displays the scanning checklist.



Before initiating the scan, carefully review the following precautions:

- Avoid using any strong external light source.
- Ensure the mirror is clean and free of stains.
- Maintain dryness in the scan area, minimizing saliva and blood presence as much as possible.
- Always maintain an appropriate distance between the scanner tip and the teeth.

Practice Mode

Practice mode is intended to help users to learn how to perform correct scans using a practice model.

You can scan the QR code attached to the practice model to download sample data, or if you've already downloaded it, you can retrieve and use the saved sample data.

Data acquired in practice mode is not saved when you exit the mode.

Note

- Go to Settings > Program Preferences > General and enable the "Practice Mode" option to display the practice mode banner.
- The Practice Mode banner only appears on full screen when there is no scan data acquired.
- The Practice Mode is not available with the i500.



The Practice Mode provides three training levels, each with different score criteria.

- Beginner: A level for novice users of an intraoral scanner.
- Intermediate: A level for intermediate users who are familiar with using an intraoral scanner.
- Advanced: A level for experienced users who want to reach the highest level beyond the intermediate level.

The acquired scan data will be deleted if the difficulty level is changed during scanning.

Entering Practice Mode

- ① Prepare the practice model that is included in the scanner package. Please contact your local service provider for additional purchases.
- ② Run Scan for Clinics and click the "Practice Mode" banner on the bottom right side of the screen.

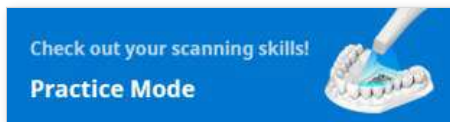

- ③ Follow the instructions presented on the screen.



- ④ Click "Download Data" to download sample data of your practice model from the server.

Note

You can also use the practice model data stored on your computer if you have already downloaded it. In this case, select the serial number that matches the one on your practice model.

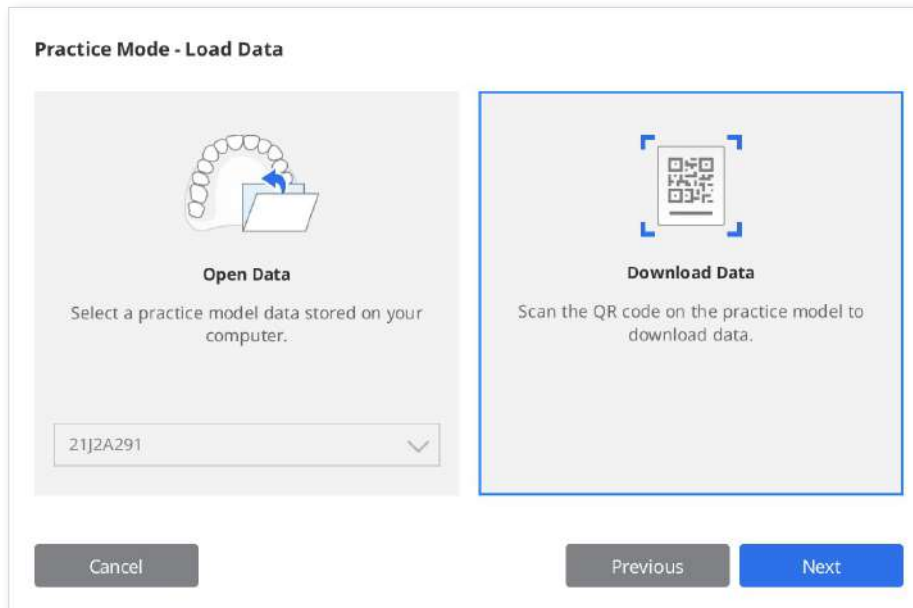

- ⑤ Scan the QR code with your scanner.
- ⑥ When the camera turns on, it will recognize the QR code. You can enter the serial number on the sticker if the QR code has been damaged.

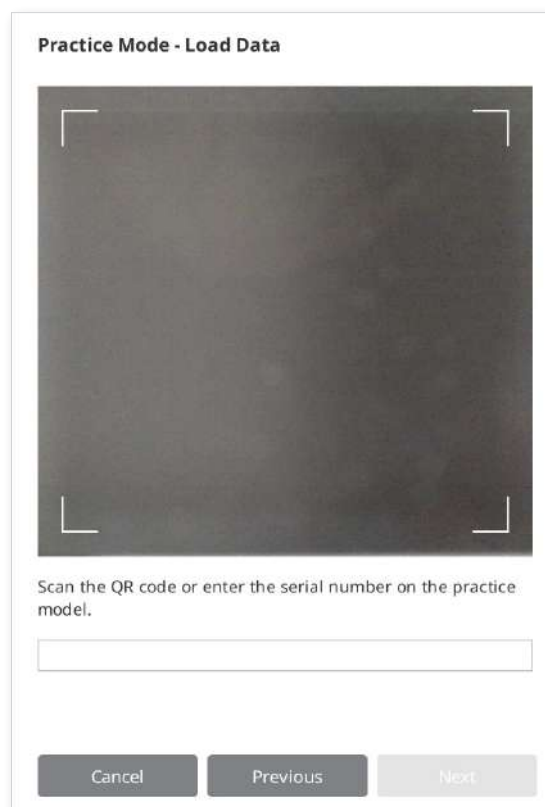

- ⑦ Click "Next" once the serial number is validated.

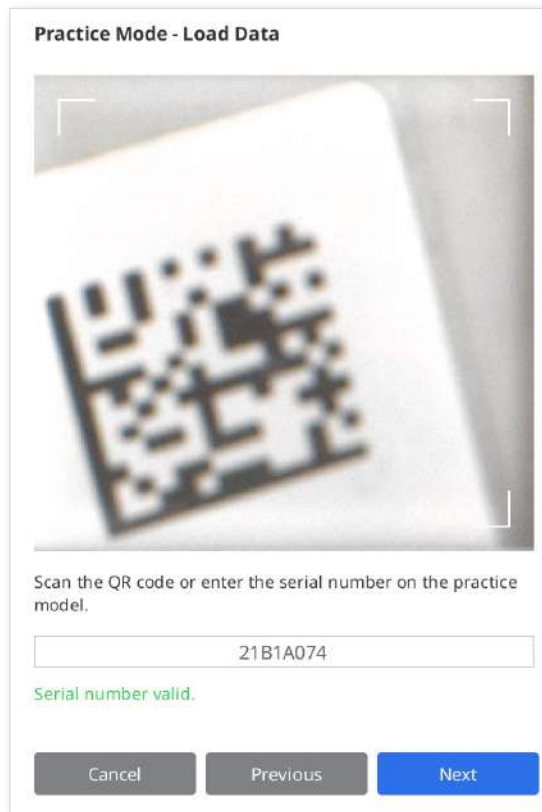

- ⑧ An information video on how to scan the practice model will be displayed during the download.

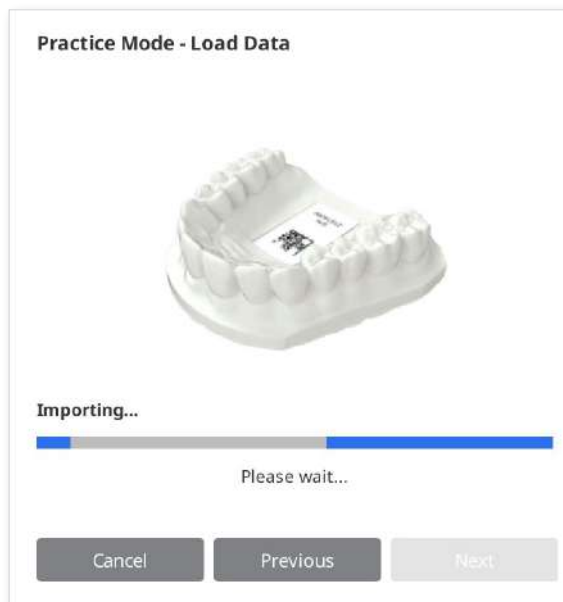

- ⑨ When the download is complete, click "Next" to select a level.

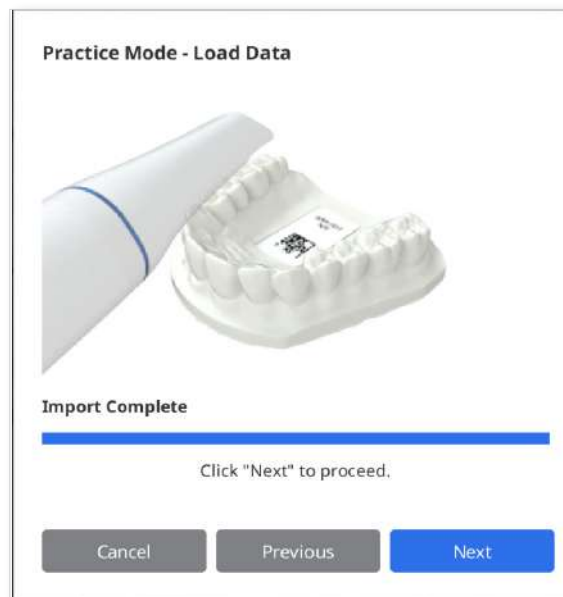



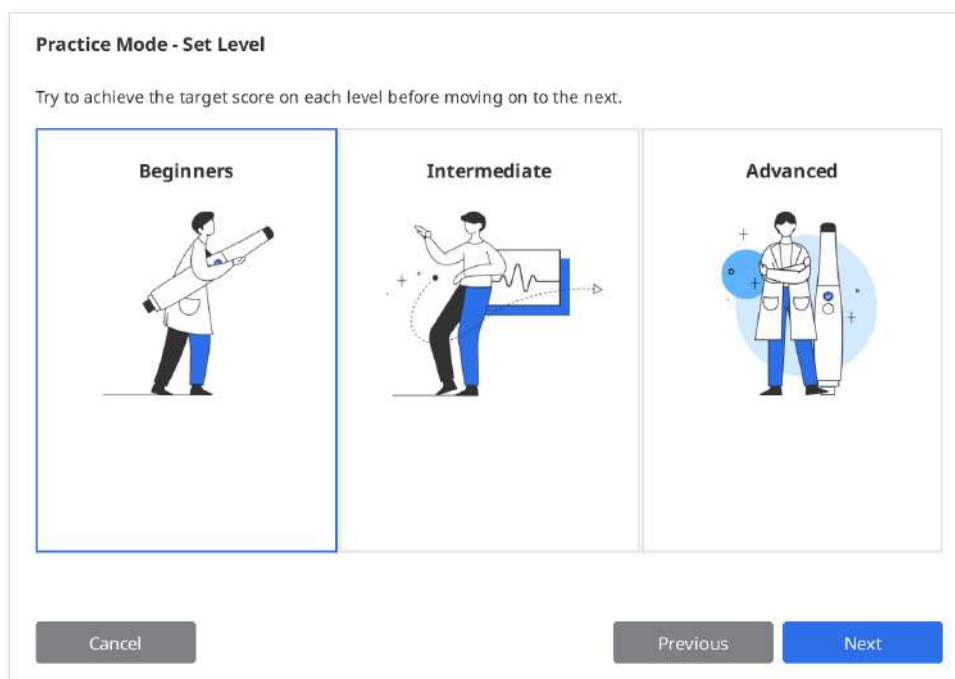

- ⑩ Select a difficulty level between the "Beginner," "Intermediate," and "Advanced," and click "Next."



- ⑪ Check the goals you need to achieve for the selected difficulty level and click "Next" to start your scanning practice. You can click "Previous" to go back and change the difficulty level.

Practice Mode - Set Level

				
Scan Time	Progress Rate	Data Reliability Ratio	Number of Major Holes	Matching Rate
2m 0s ↓	100 %	90 % ↑	2 ↓	90 % ↑

Do you think you can scan as accurately as possible within the target scan time above?
If not, don't worry! Practice makes perfect.

You can practice acquiring accurate data by following the scanning guidelines provided in Practice Mode and learn how to remove major holes and improve your data reliability by acquiring additional data.

Also, we provide you with the resulting data to review the reliability of your data based on the acquired sample data.

Scanning Practice

- ① Click the "Scan" button to start once the downloaded sample data is displayed on the screen.

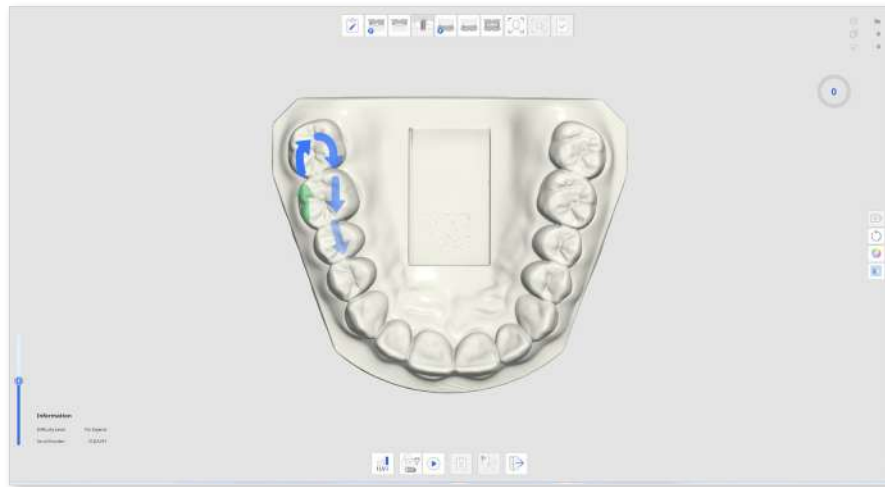

- ② Follow the instructions and directions of the arrows to scan the practice model.
- ③ Check the scan information and progress while acquiring data for your effective scanning practice.

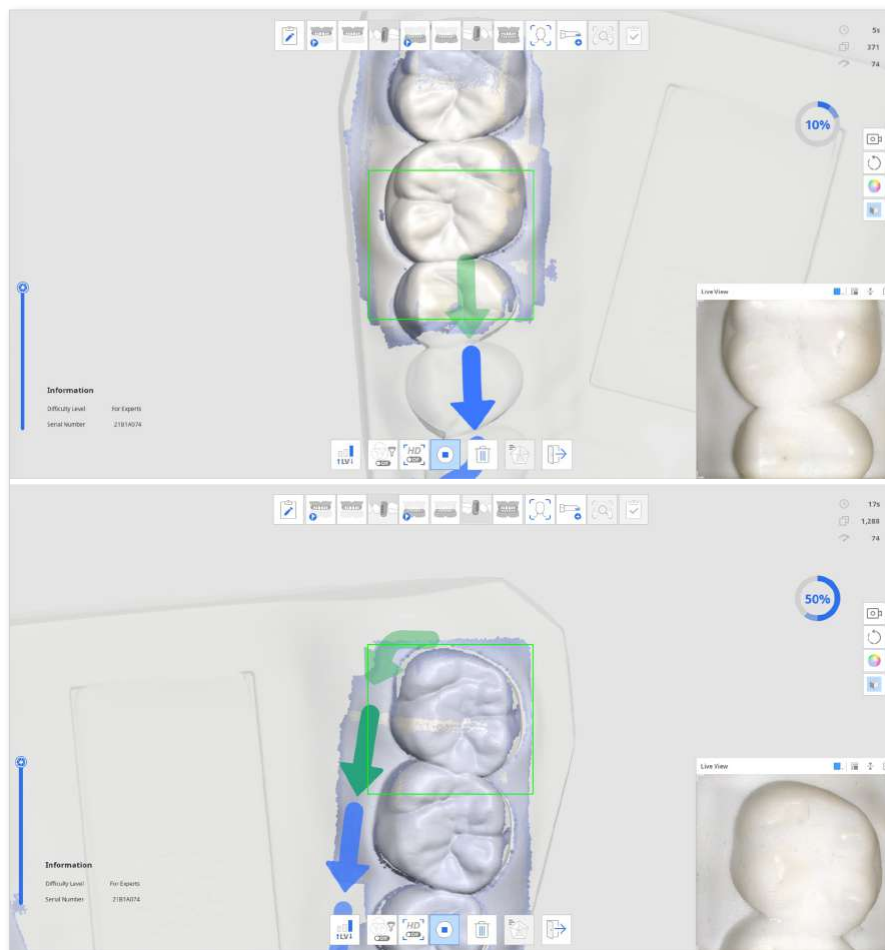

- ④ When a certain amount of scan data is acquired, the progress turns into a check mark, and the "Check Practice Mode Results" icon at the bottom is enabled.



- ⑤ Click the "Check Practice Mode Results" icon to check the score.

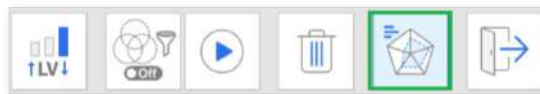

- ⑥ The score will be based on the selected difficulty level, scan time, progress rate, data reliability ratio, etc.

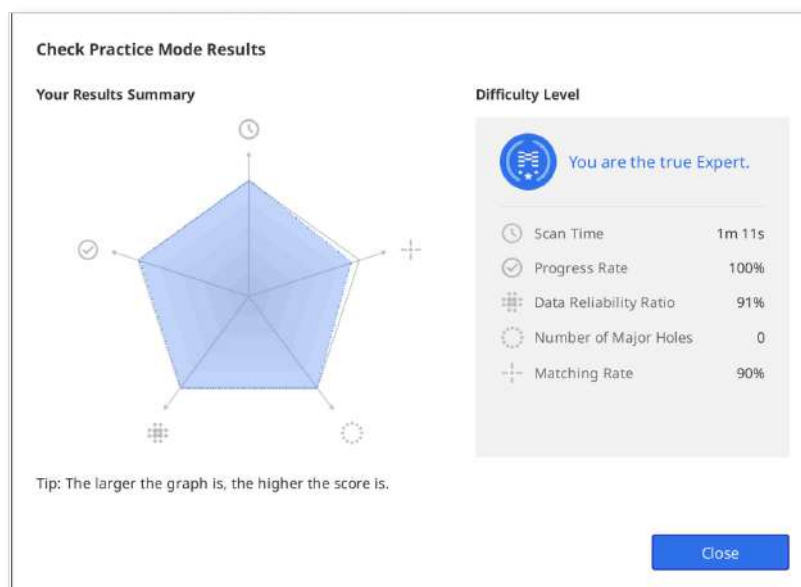

- ⑦ You can conduct additional scans after viewing the results and check the results again based on the data after additional scanning.

Touch Interface Tutorial

The following Touch Interface Tutorial dialog appears when the program connects with the i900 scanner for the first time.

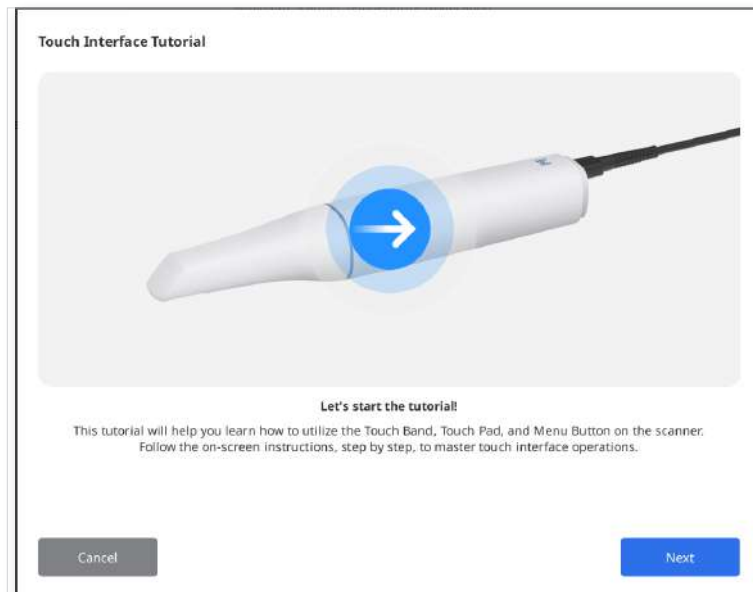

Follow the instructions in the dialog to learn how to utilize the Touch Interface so that you can scan with minimal mouse and keyboard interaction.

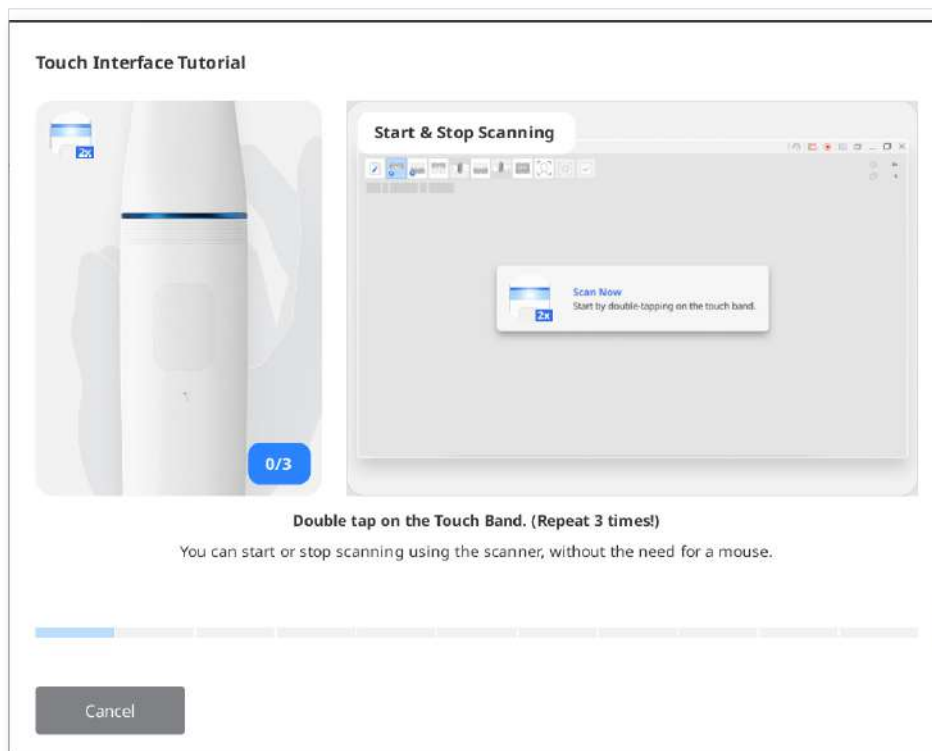

Note

To rerun the tutorial, go to Settings > Scanner and click the "Run" button next to the "Touch Interface Tutorial" option.

Indication During Scanning

The color of the rectangular box that appears during scanning indicates the scan status.

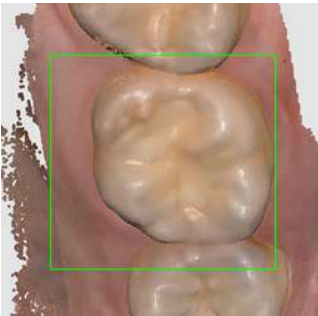
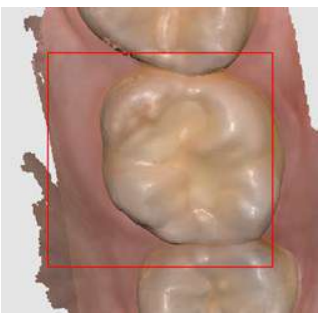
	
Scanning and tracking are proceeding normally.	Lost tracking while scanning. You need to reposition the scanner tip to scan continuously from where you left off.

Smart Arrow

The Smart Arrow indicates areas of low reliability on the acquired scan data.

When you stop scanning, a blue arrow points to the area with insufficient reliability. The arrows disappear when data reliability improves with additional scanning.

This function is only supported in the scan stages:

- Pre-Op for Maxilla
- Pre-Op for Mandible
- Maxilla
- Mandible
- Smart Scan Review

- ① Scan data in one of the supported scan stages.
- ② When the scan stops, blue arrows will appear to indicate areas with low data reliability.



③ Check the scan data by reviewing the marked areas. You can inspect the area in closer detail by selecting the "Reliability Map" or "Texture On + Reliability Map" for Model Display Mode.

- Texture on



- Texture Off

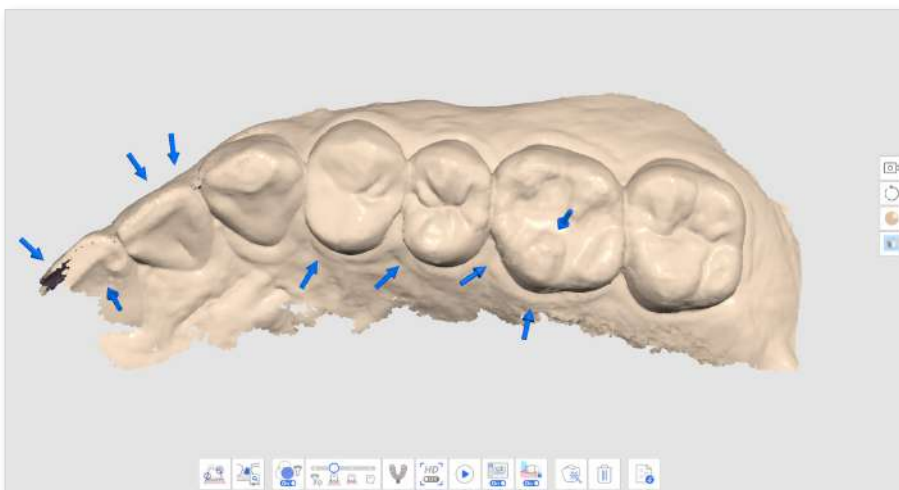

- Reliability Map

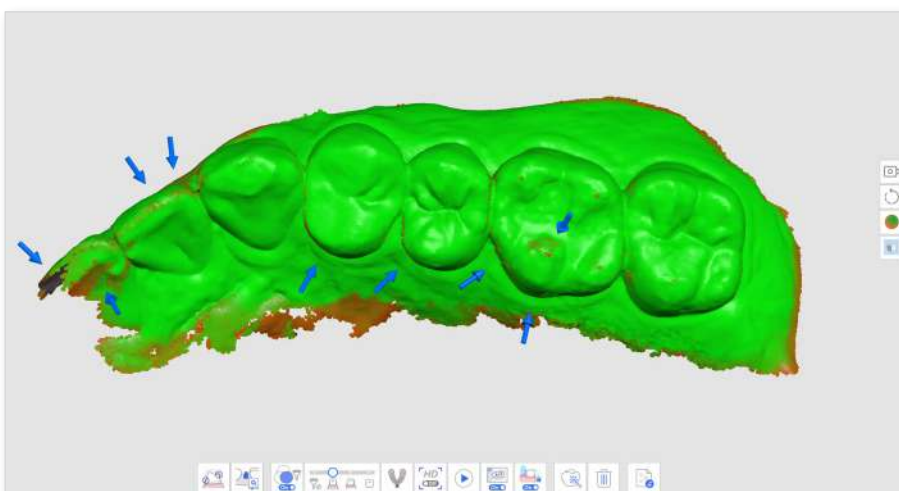

- Texture on+ Reliability Map

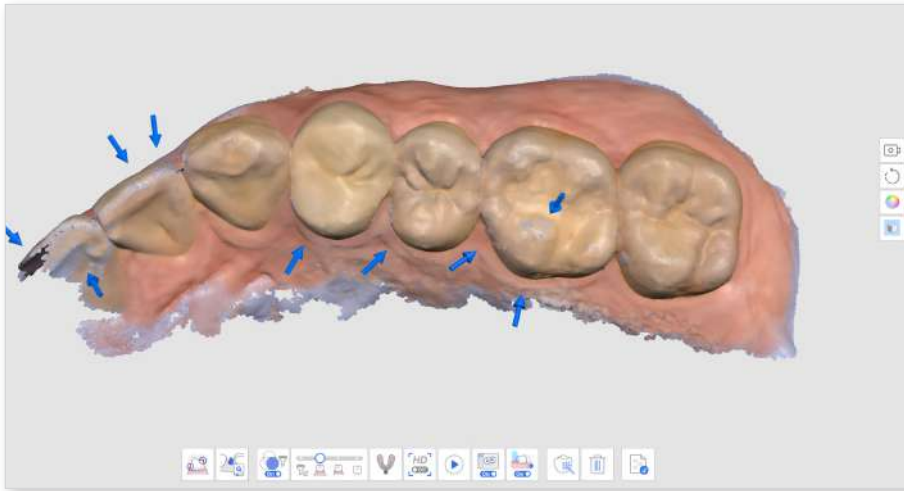

- ④ Scan additional data to fulfill the lacking areas. Move the scanner in multiple directions and scan data from various angles to improve data reliability.
- ⑤ The arrow disappears when enough reliable data is acquired.
- ⑥ Scan thoroughly to remove all arrows around your areas of interest (for example, if creating a restoration, focusing on margins and adjacent teeth) and move on to the next scan stage.

Smart Scan Guide

The Smart Scan Guide identifies any unusual actions during the scanning and provides appropriate guidance. The message automatically disappears after a period of time or if the situation is resolved.

- When there is too much data filtered out while scanning using Smart Scan Filtering

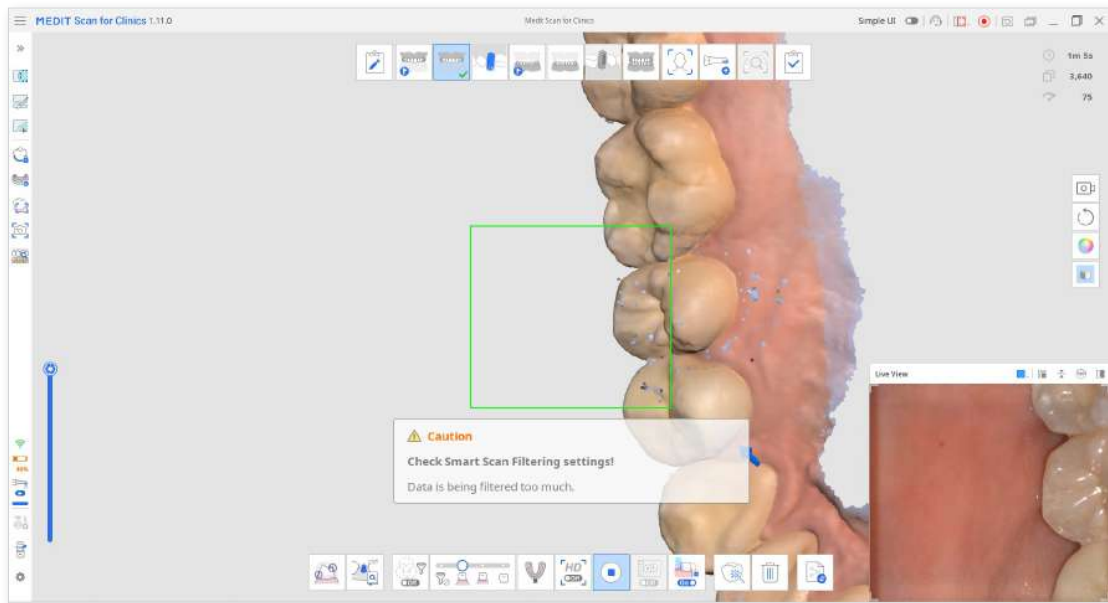

- When the scan is inconsistent, and the scan continues from a new place (when Smart Stitching is turned off)

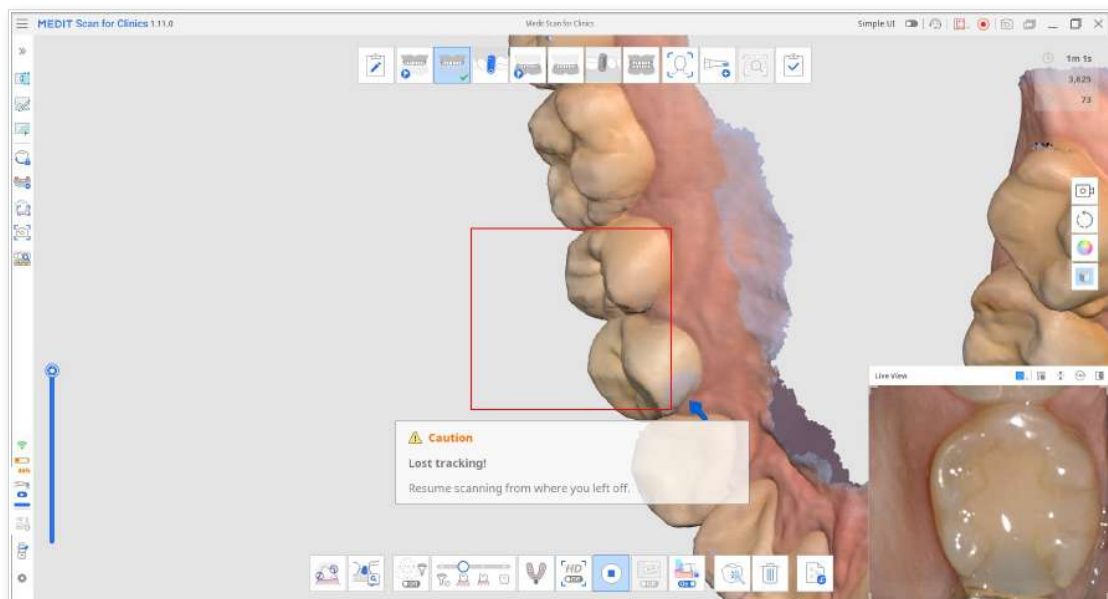

- When the scanner is not close enough to the teeth

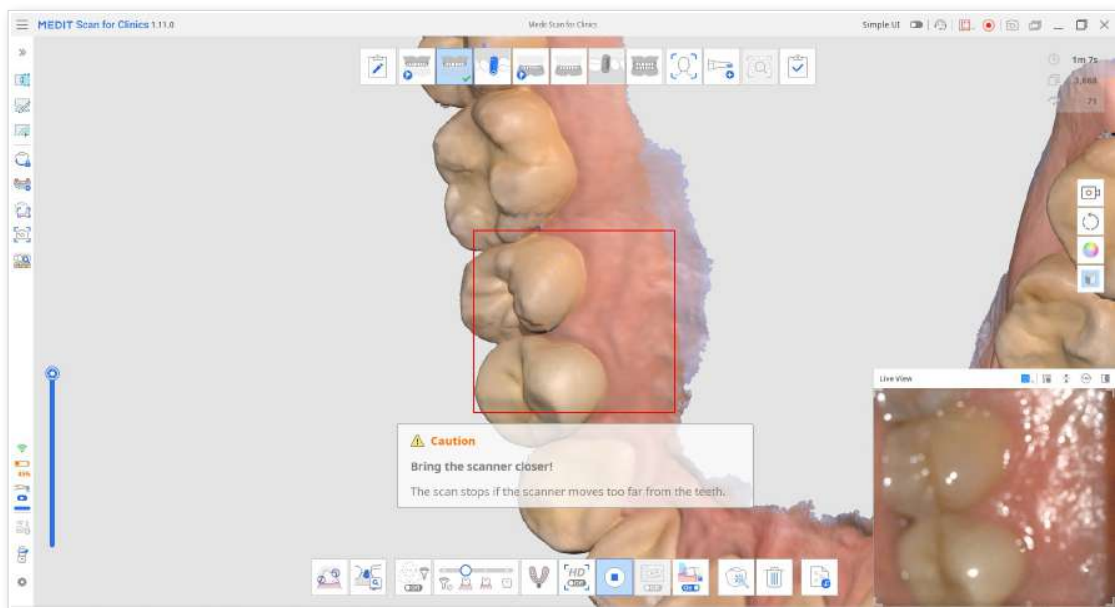

When the scan stops, additional guides are provided in the Info Box in the top left corner.

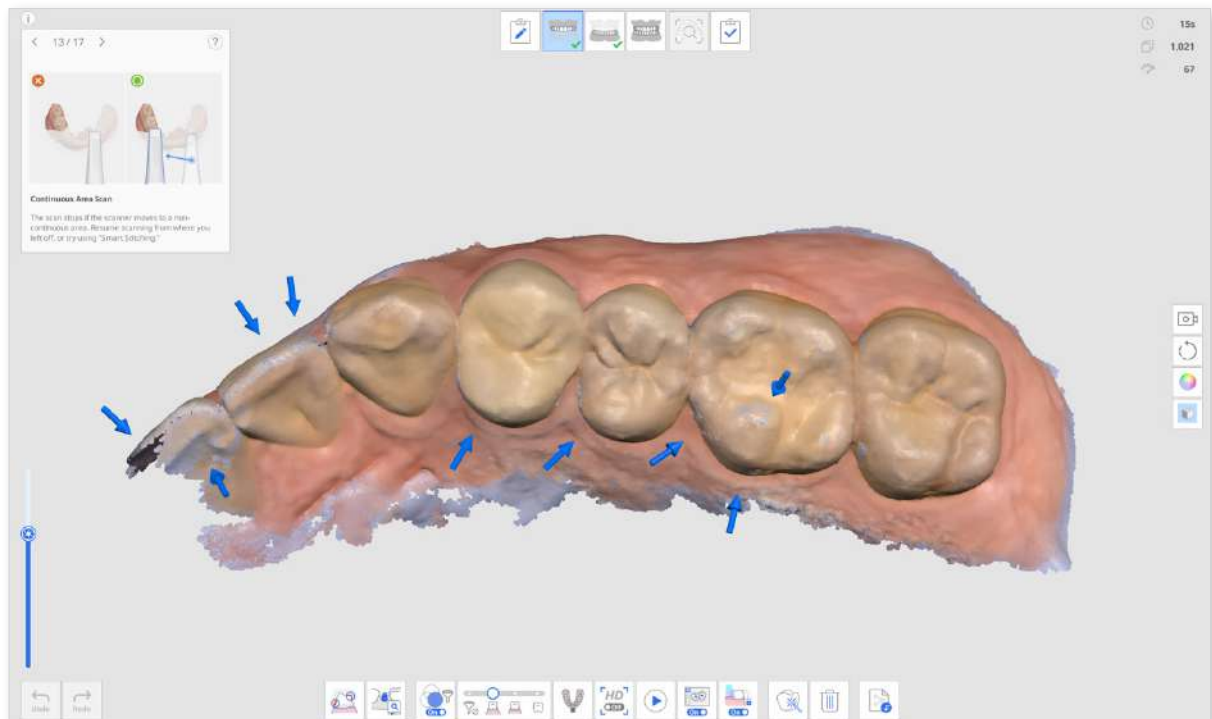

Scan Stages

Stage Management

Stages Management

Scan for Clinics offers Maxilla, Mandible, and Occlusion as default scan stages.



The Stage Management icon allows users to add or delete the stages to/from their workflow and change the order regardless of the form information registered in Medit Link.



In the Stage Management dialog, you can configure your workflow by adding or removing stages.

Note











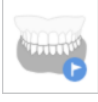

- You cannot change the order of the Face and Additional Data stages in the workflow.



- You cannot change the order of the Smart Scan Review stage, but you can remove the stage on Settings > Scan Data Analysis > Smart Scan Review.
- You cannot change the order of the Complete stage or remove it.

Scan Stages

The following scan stages can be set in the Scan Management stage:

	Pre-Op for Maxilla	Acquire a 3D image of the pre-op for the maxilla.
	Pre-Op for Mandible	Acquire a 3D image of the pre-op for the mandible.
	Maxilla	Acquire a 3D image of the maxilla.
	Maxillary Scan Body	Acquire a 3D image of the scan body of the maxilla.
	Mandible	Acquire a 3D image of the mandible.
	Mandibular Scan Body	Acquire a 3D image of the scan body of the mandible.
	Edentulous Maxilla	Acquire a 3D image of the edentulous maxilla.
	Maxillary Denture	Acquire a 3D image of the maxillary denture.
	Edentulous Mandible	Acquire a 3D image of the edentulous mandible.
	Mandibular Denture	Acquire a 3D image of the mandibular denture.
	Occlusion	Acquire a 3D image of the occlusion alignment.
	Face	Acquire 3D data of the teeth, mouth, nose, etc.
	Additional Data	Acquire additional data for the scanning process. You can scan patients' existing restorations, temporary restorations, etc.

Note

- The Maxillary/Mandibular Denture stage is available when Full Denture, Replica Denture, or Implant Supported Denture is specified in the form information on Medit Link.
- The Edentulous Maxilla/Mandible stage is available when Full Denture or Implant Supported Denture is specified in the form information on Medit Link.

Add/Remove Stages

- ① Click the Stage Management icon.



- ② The Stage Management dialog appears.
- ③ Click the stages you want to add from the list in the right section.

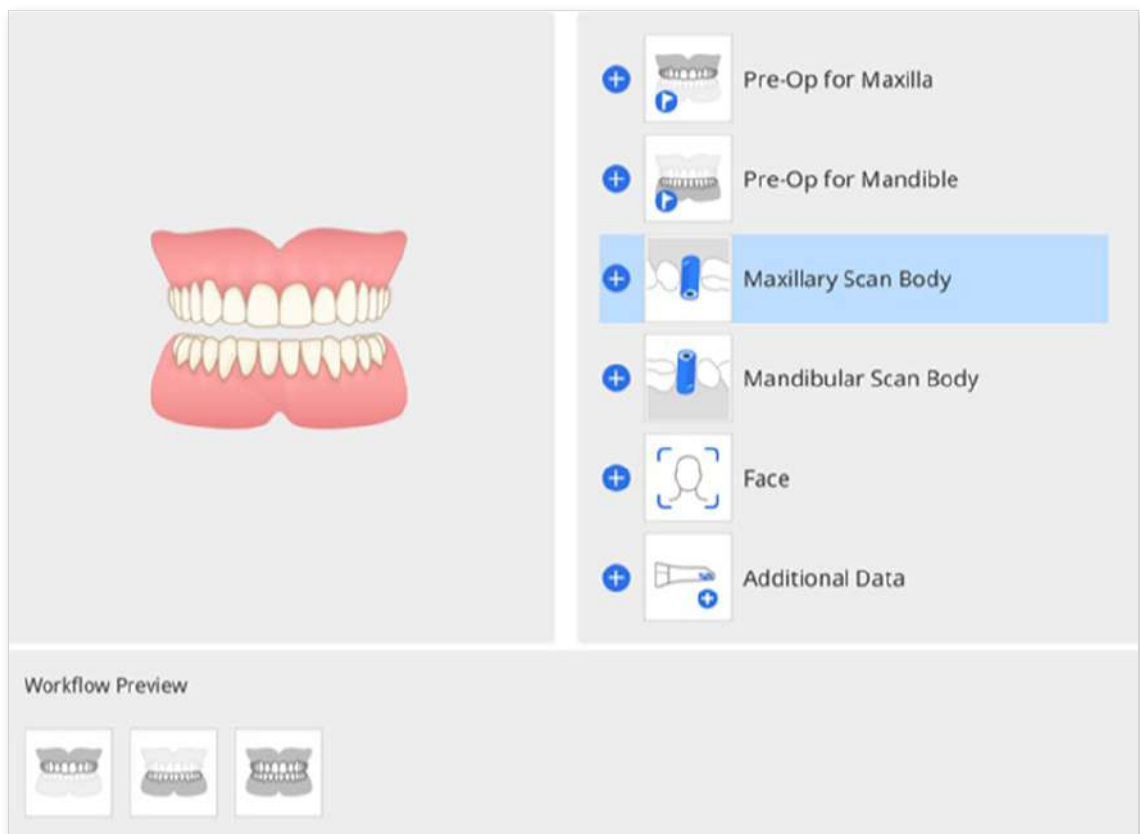

- ④ The selected stage is added to the Workflow Preview section at the bottom.

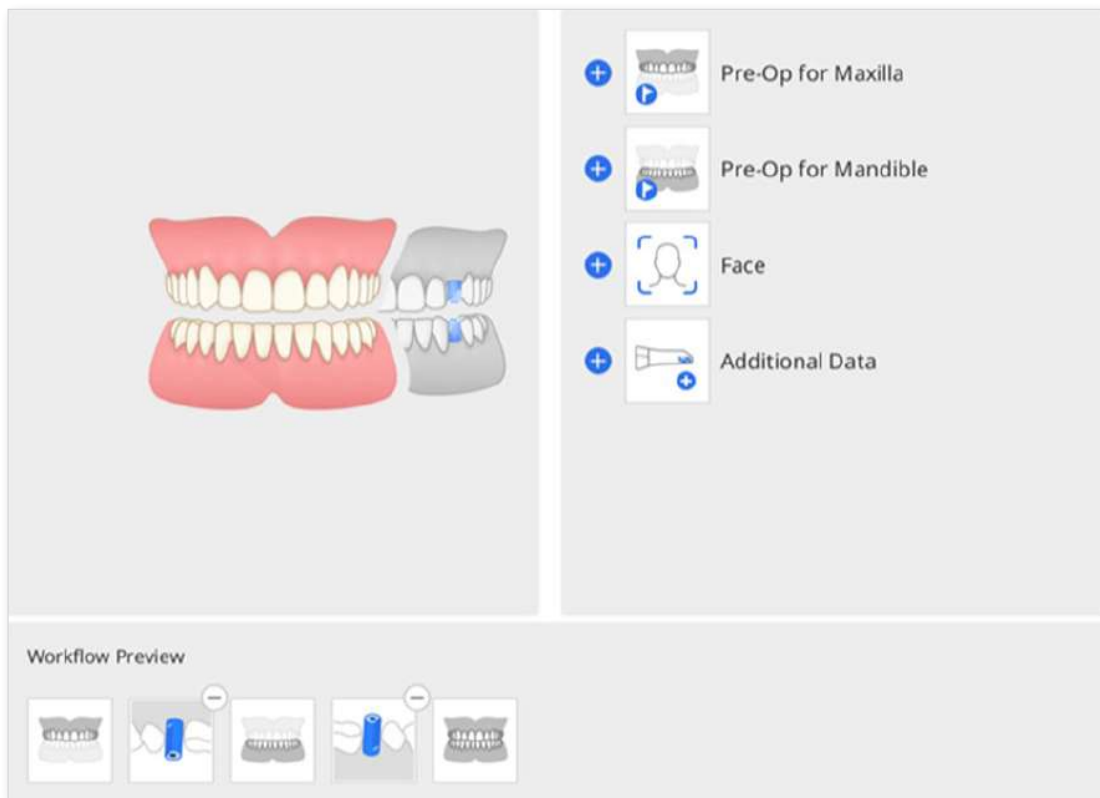

- ⑤ You can change the order of stages in the workflow by dragging the stage icons in the Workflow Preview. Clicking ⊖ in the upper right corner of the stage icon will delete the stage from the workflow.



- ⑥ Click "OK" to save the changed workflow.
- ⑦ The Stage Management dialog disappears, and the stage icons at the top of the screen update according to the changed workflow.



Save as Default Workflow

- ① Click the Stage Management icon to run the Stage Management.

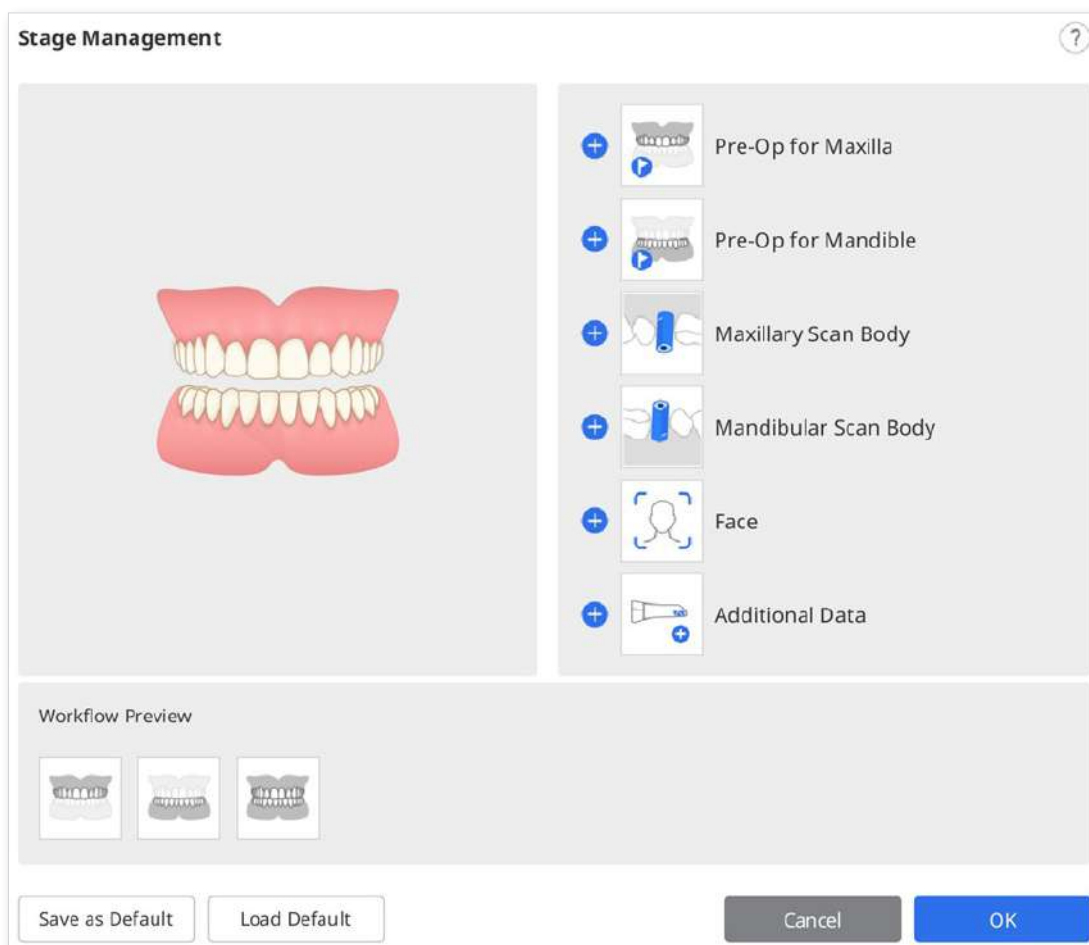

- ② Add the desired stages from the stage list to the Workflow Preview.

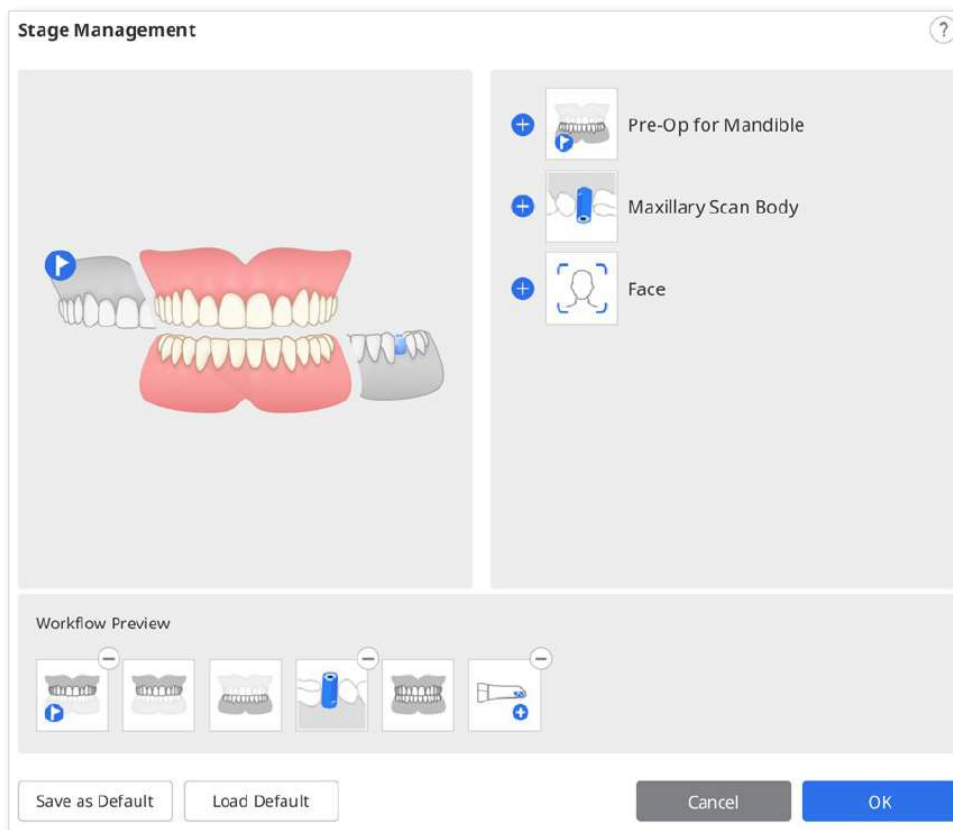

- ③ Click "Save as Default" at the bottom to save the changed workflow.

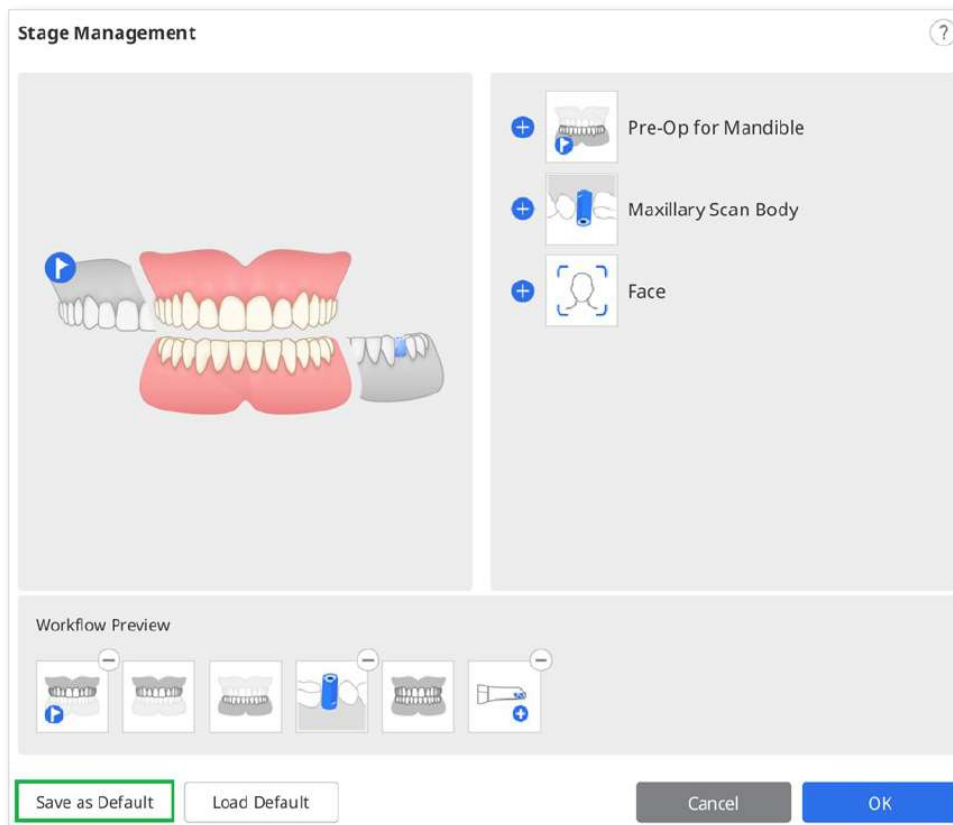

- Click "Confirm" to continue.



- The default scan stages are displayed at the top of the screen when you open a new case.



Change Stage Order

You can move a stage icon to the desired position where blue bars appear.

Let's say you want to stage a Mandible stage to the frontmost position.

- Check the stage icons at the top of the screen.

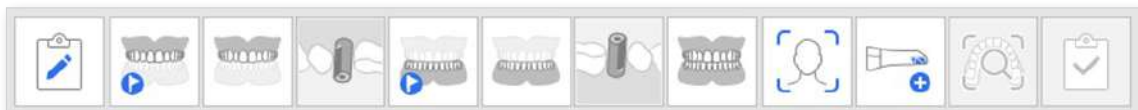

- ② Click and drag the Mandible stage icon. Then, the blue bar appears where the scan stage can be moved.

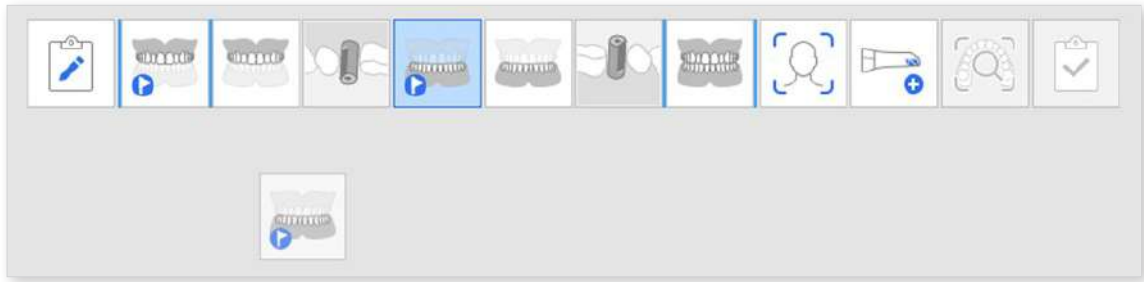

- ③ Move the scan stage to the desired location.



- ④ Once changed, the program will continue to start with the changed order from then on.

 **Note**

The Scan Body stage moves along with the Mandible/Maxilla stage.

For example, if you drag the Mandible stage to the left most position, the Mandibular Scan Body stage moves with it, as shown below.



Pre-Op for Maxillar/Mandible

Pre-Op for Maxilla Stage

	Acquire a 3D image of the pre-op for the maxilla.
---	---

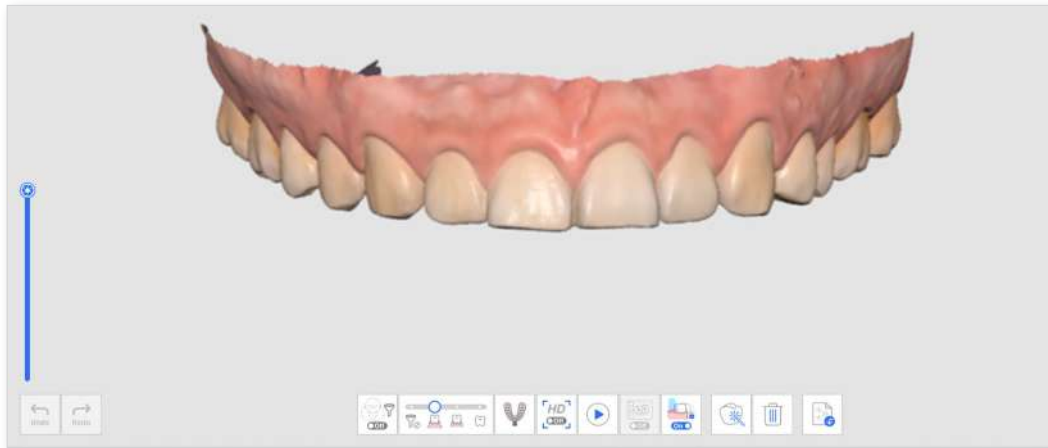

Pre-Op for Mandible Stage

	Acquire a 3D image of the pre-op for the mandible.
---	--

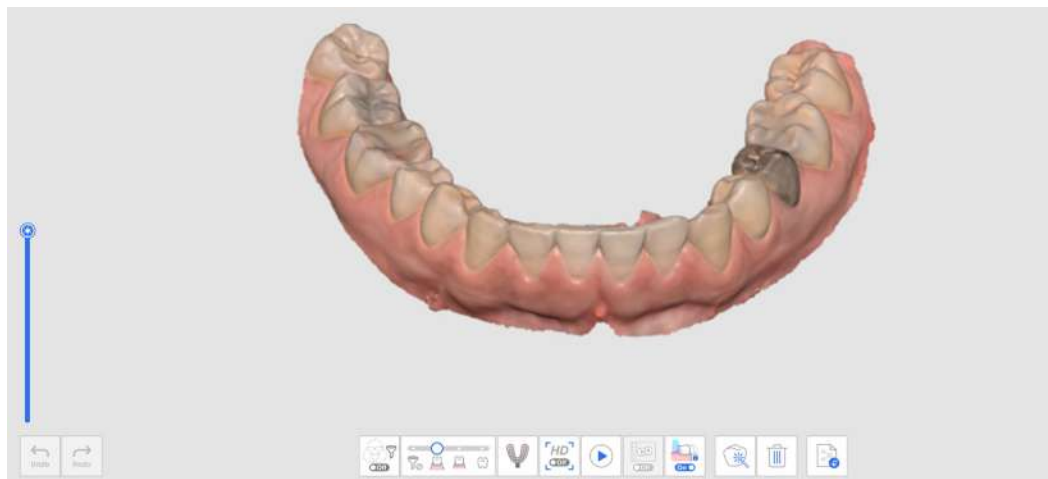

Additional Tool in Pre-Op Stage

Please refer to [Scan Stage](#) Tools for more information about how to use tools that appear at the bottom of the screen for each stage.

	Impression Scan	Acquire impression data and align it with intraoral scan data in real time.
---	-----------------	---

Maxillar/Mandible

Maxilla Stage

	Acquire a 3D image of the maxilla.
---	------------------------------------



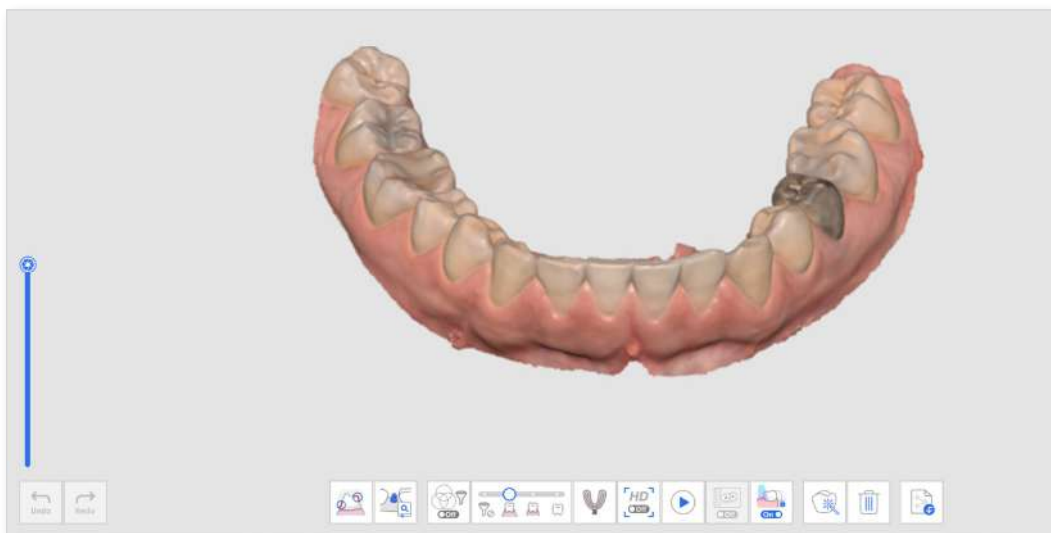

Mandible Stage

	Acquire a 3D image of the mandible.
---	-------------------------------------



Additional Tools in Maxillar/Mandible Stage

Please refer to [Scan Stage Tools](#) for more information about using tools at the bottom of the screen.

	Impression Scan	<p>Acquire impression data and align it with intraoral scan data in real time.</p> <p>* Refer to Case and Workflow Examples > Impression Scan for a detailed description of how to use the tool.</p>
	Abutment Library Matching	<p>Manage custom abutment libraries. This library data is aligned automatically with the scan data, minimizing the need to scan difficult-to-reach areas. The library data can be shared for further processes, such as design.</p> <p>* Refer to Case and Workflow Examples > Abutment Library Matching for a detailed description of how to use the tool.</p>
	Preparation Review	<p>Check the prepared tooth data with insertion path and distance measurements.</p> <p>* Refer to Case and Workflow Examples > Preparation Review for a detailed description of how to use the tool.</p>

Scan Body

Maxillary Scan Body Stage



Acquire a 3D image of the scan body of the maxilla.

Mandibular Scan Body Stage



Acquire a 3D image of the scan body of the mandible.



Additional Tools for Scan Body Stage

Please refer to [Scan Stage Tools](#) for more information about using tools at the bottom of the screen for each stage.

	<p>Scan Body Library Matching</p>	<p>Manage custom scan body libraries. This library data is aligned automatically with the scan data, minimizing the need to scan difficult-to-reach areas. The library data can be shared for further processes, such as design.</p> <p>* Refer to Case and Workflow Examples > Scan Body Library Matching for a detailed description of how to use the tool.</p>
	<p>Replicate Existing Data</p>	<p>Replicates existing maxilla/mandible data.</p>

Replicate Existing Data

- ① Acquire data in the Maxilla or Mandible stage.

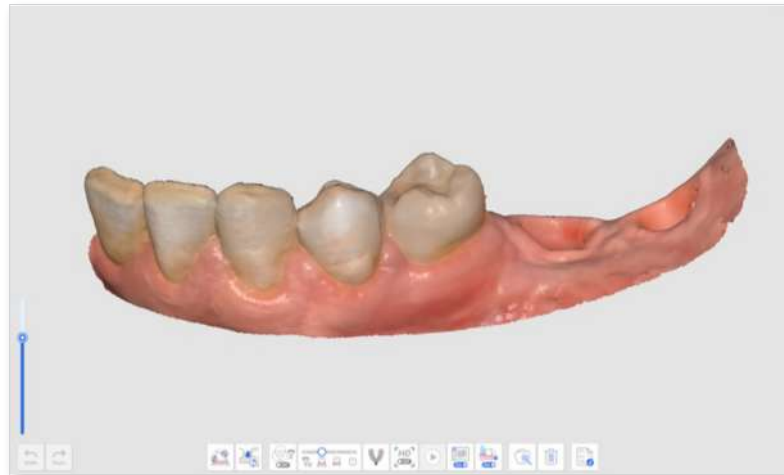

- ② Move to the Scan Body stage and click the "Replicate Existing Data" icon at the bottom.



- ③ The data in the Maxilla or Mandible stage is replicated in the Scan Body stage. The number of frames is updated after copying the data.



- ④ You can remove data with trimming tools in the area where the scan bodies will be placed.

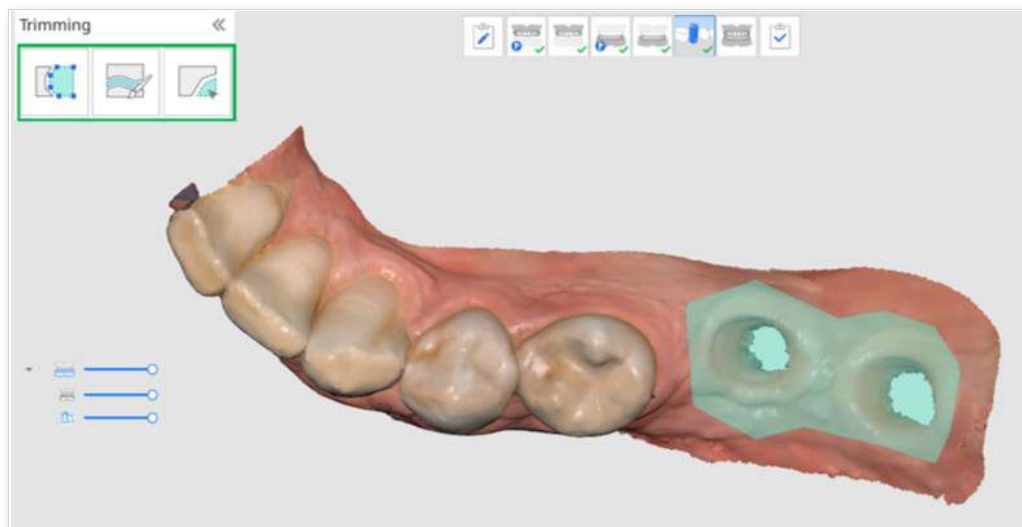

- ⑤ Mount the scan bodies on the maxilla or mandible and acquire the scan body data.



Edentulous Maxilla/Mandible

Note

- The Edentulous Maxilla/Mandible stage appears when Full Denture or Implant Supported Denture is registered in the form information on Medit Link.
- The Edentulous Maxilla/Mandible stage appears instead of the Maxilla/Mandible stage when you add the Denture stage in the Stage Management after running Medit Scan for Clinics from the Arch tab on the Medit Link.

Edentulous Maxilla Stage



Acquire a 3D image of the edentulous maxilla.



Edentulous Mandible Stage

	Acquire a 3D image of the edentulous mandible.
---	--



Additional Tools for Edentulous Stage

Please refer to Scan Stage Tools for more information about how to use tools that appear at the bottom of the screen for each stage.

	Relined Denture Scan	Scan the fitting surface of the relined denture, which will be utilized as an edentulous scan. This helps reproduce the edentulous environment for the optimal denture manufacturing process.
---	-----------------------------	---

Maxillary/Mandibular Denture

Note

The Maxillary/Mandibular Denture stage appears when the Medit Link form is registered as a Full Denture or Implant Supported Denture.

When running Medit Scan for Clinics after selecting Arch in Medit Link, you can add the Maxillary/Mandibular Denture stage to the workflow from Stage Management.

Maxillary Denture Stage



Acquire a 3D image of the maxillary denture.



Mandibular Denture Stage



Acquire a 3D image of the mandibular denture.



Occlusion

Occlusion Stage





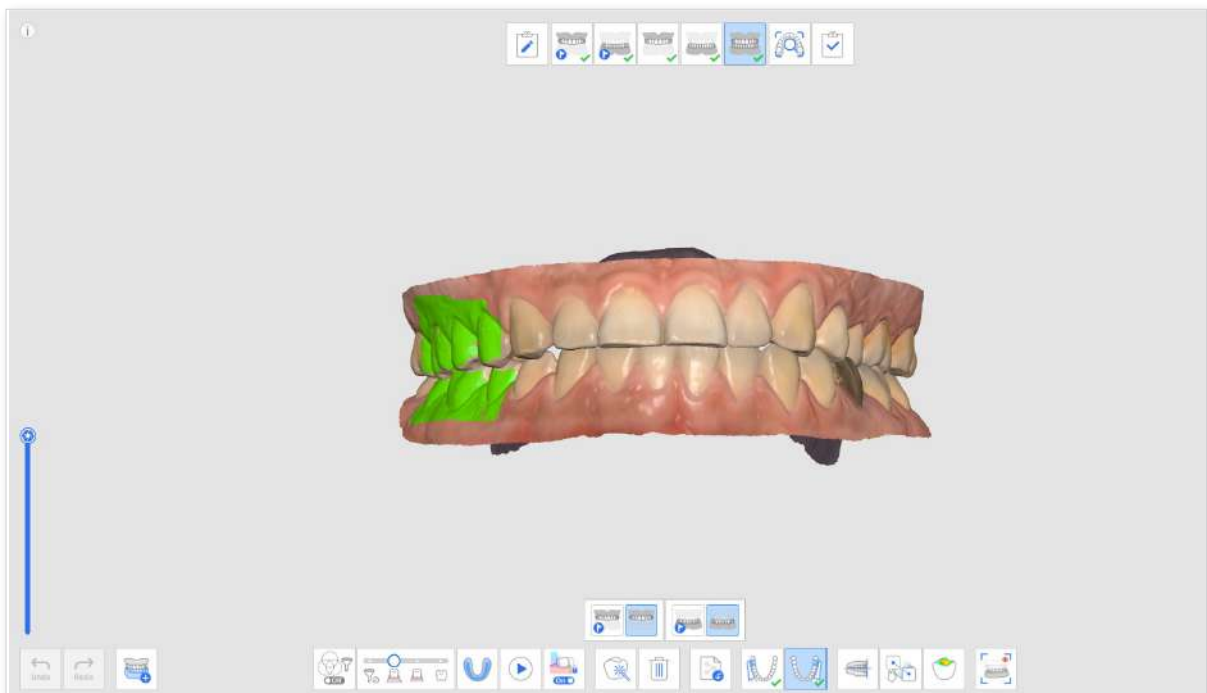









Acquire the 3D image of the occlusion.



Additional Tools for Occlusion Stage

Please refer to Scan Stage Tools for more information about how to use tools that appear at the bottom of the screen for each stage.

	Multi Occlusion	Reproduce various types of occlusion scan data and alignment. Only available on Occlusion scan stage.
	Impression Scan	Acquire impression data and align it with intraoral scan data in real time.
	Occlusion Target for Maxilla	Choose between the pre-operation maxilla and maxilla data for occlusion alignment.
	Occlusion Target for Mandible	Choose between the pre-operation mandible and mandible data for occlusion alignment.
	First Occlusion	Acquire a first scan data for occlusion alignment.
	Second Occlusion	Acquire a second scan data for occlusion alignment. The second occlusion is often acquired on the opposite side of the first occlusion.
	Align with Occlusal Plane	Move the data location to the occlusal plane that is comparable with exocad.
	Manual Alignment	Align the scan data manually using user-defined points.
	Detach Maxilla	Detach the maxilla and move it back to the prealignment position.
	Detach Mandible	Detach the mandible and move it back to the pre-alignment position.
	Detach Occlusion Data	Detach first and second occlusion data and move them back to the pre-alignment position.
	Detach All	Detach all data and move it back to the prealignment position.

	<p>Mandibular Movement</p>	<p>Record and simulate patients' actual mandibular movement when occlusion is aligned.</p>
---	----------------------------	--

Multi Occlusion

The Multi Occlusion Group function in the occlusion scan stage can reproduce various occlusion scan data and alignments. Multiple occlusion patterns can be acquired in patients with large or irregular tooth movements. Various occlusions can be created and managed in the case, such as centric relation for the edentulous patient, open bite for the production of a mouthpiece, protrusive occlusion for the production of snoring prevention appliance, and centric occlusion for patient treatment in clinics.

The "Multi Occlusion Management" dialog enables you to conduct the following functions:

- Add Occlusion Group
- Delete Occlusion Group
- Change Name

You can create up to 5 occlusion groups, and the scanned data for the selected occlusion group is displayed on the screen. You can freely select the target for occlusion in each group.

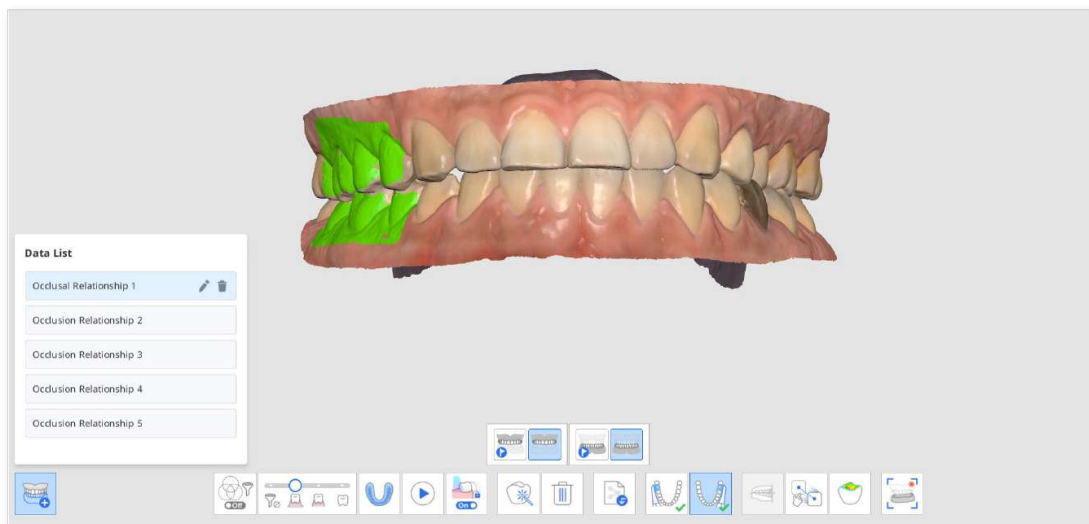

Note

Since scan data of the same maxilla and mandible is reproduced according to the alignment of each occlusion group, this function is not available if scan data of different maxilla and mandible is required.

- ① Acquire maxillary and mandibular data in the Maxilar and Mandible stages.
- ② Move to the Occlusion stage.



- ③ Click the "Multi Occlusion Group" icon at the bottom to open the Data List.

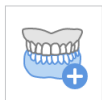

- ④ The existing occlusion scan data will be assigned as Occlusal Relationship 1. You can add, delete, or rename the occlusion groups in the Data List.



- ⑤ Perform the first and second occlusion scans, and align the scan data of the maxilla, mandible, and occlusion.

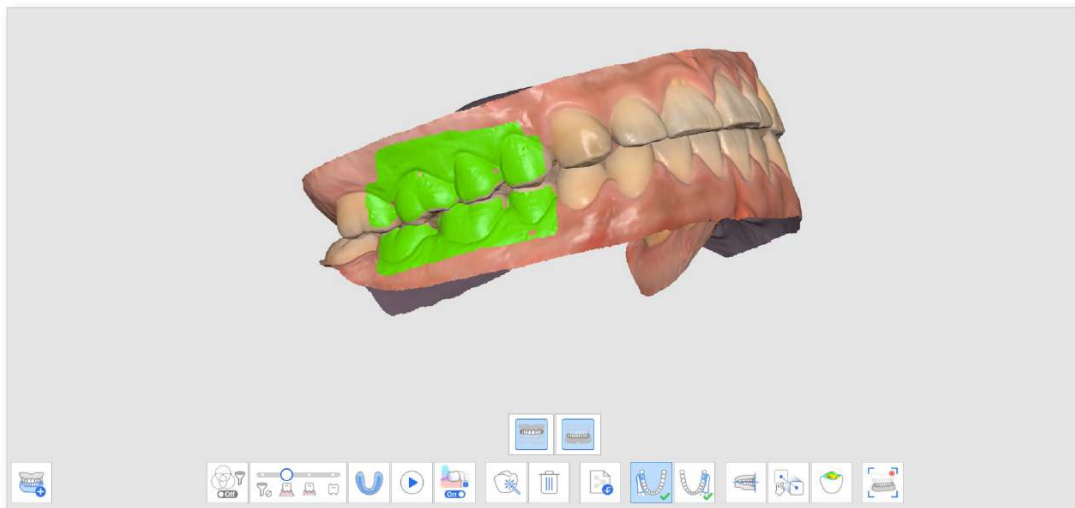
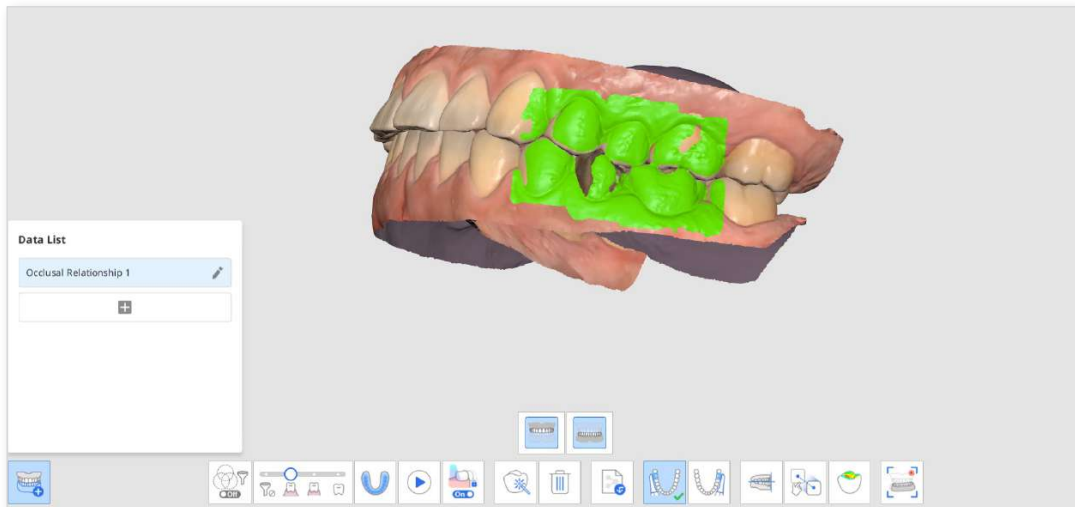

- ⑥ Click "Add" to create a new occlusion group.

- ⑦ Enter the first occlusion scan after the new occlusion group is created.

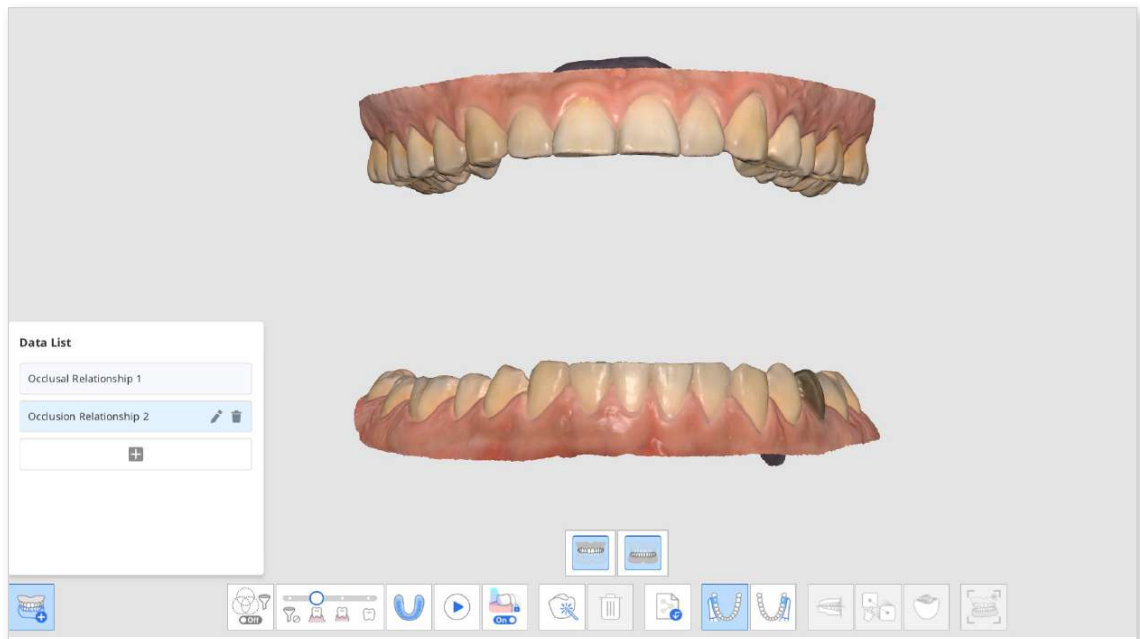

- ⑧ Perform the new occlusion scans, and align the scan data of the maxilla, mandible, and occlusion.
- ⑨ You can create up to 5 occlusion groups.
- ⑩ In the Data List dialog, you can create a new group, change the names of the created groups, and delete groups.

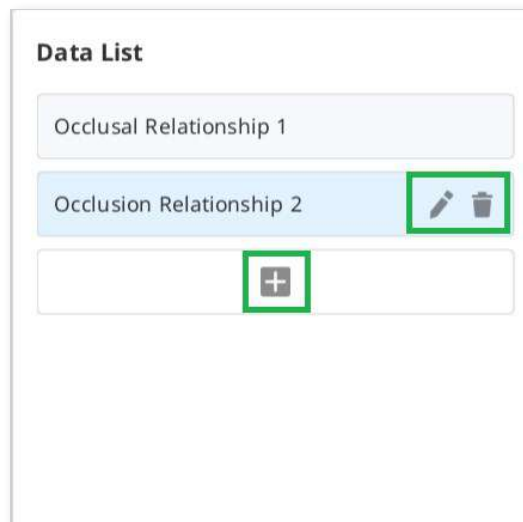

- ⑪ Scan data of various occlusion groups and alignment can be checked by using the "Multi Occlusion Group" function in Overview.



Occlusion Target for Maxilla/Mandible

You can select an occlusion target between pre-op data and prepared data for both the maxilla and mandible.

- ① Acquire maxillary/mandibular pre-op and maxillary/mandibular data in the Pre-Op for Maxilla/Mandible and Maxilar/Mandible stages.
- ② Move to the Occlusion stage. You will see the four icons to select the occlusion target for the maxilla and mandible.

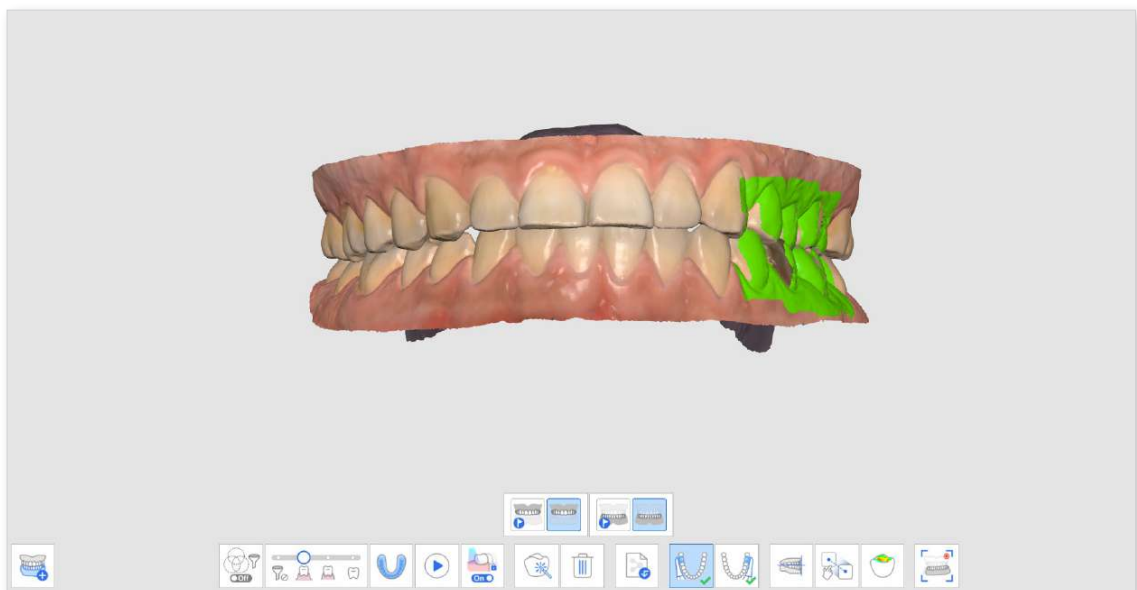



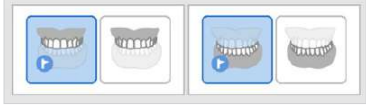
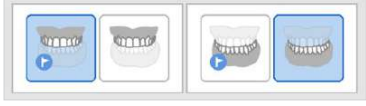
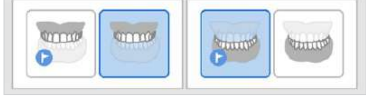
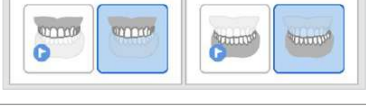



③ Choose one of the four pairs for occlusal alignment.

Pre-Op for Maxilla / Pre-Op for Mandible	
Pre-Op for Maxilla / Mandible	
Maxilla / Pre-Op for Mandible	
Maxilla / Mandible	

Align with Occlusal Plane

You can adjust the position of scanned data on the occlusal plane in Medit Scan for Clinics and make it compatible with the virtual articulator in exocad.

The following tools are provided for the Align with Occlusion Plane feature.

	Half Arch Alignment	Align the half arch with the occlusal plane by setting three matching points on the data and the plane.
	Align With Occlusal Plane By Three Points	Select three points on the maxilla or mandible to align with the occlusal plane.
	Align With Occlusal Plane By Four Points	Select four points on the maxilla or mandible to align with the occlusal plane. It is beneficial when there are no anterior teeth.
	Delete Marker Point	Remove points that were selected for alignment.
	Detach Data	Separate the aligned data and move it to the original position.
	Multi-View	3D scan data can be viewed from four sides.
	Exit	Return to the previous step.

- ① Click "Align with Occlusal Plane" after the occlusion alignment is complete.

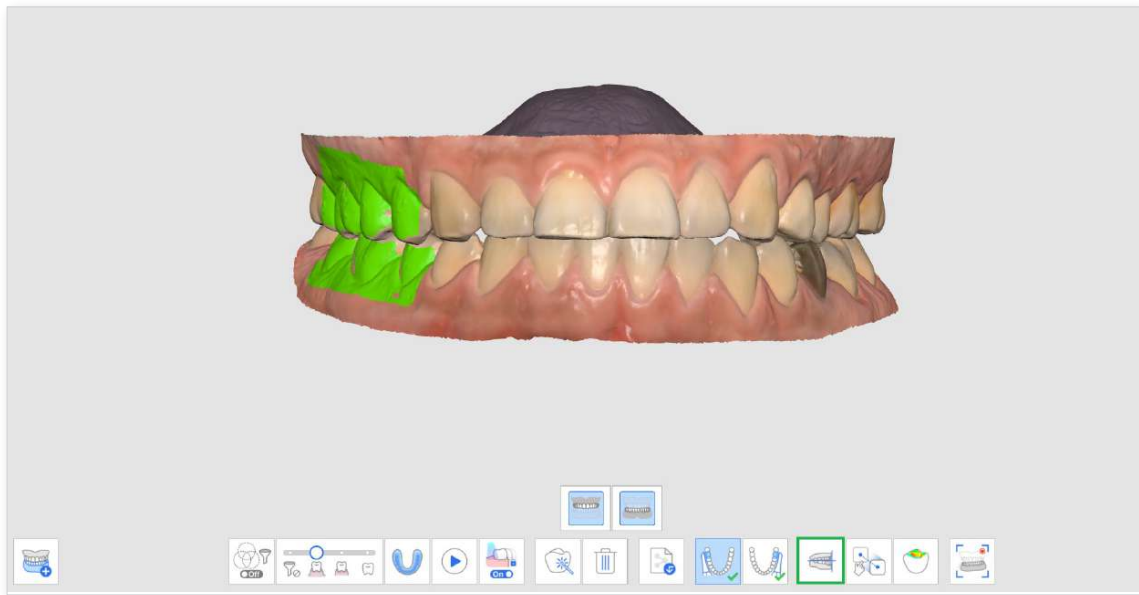

- ② Select three or four points on the maxilla or mandible. If there are no anterior teeth, select four points on the corresponding teeth on both sides.

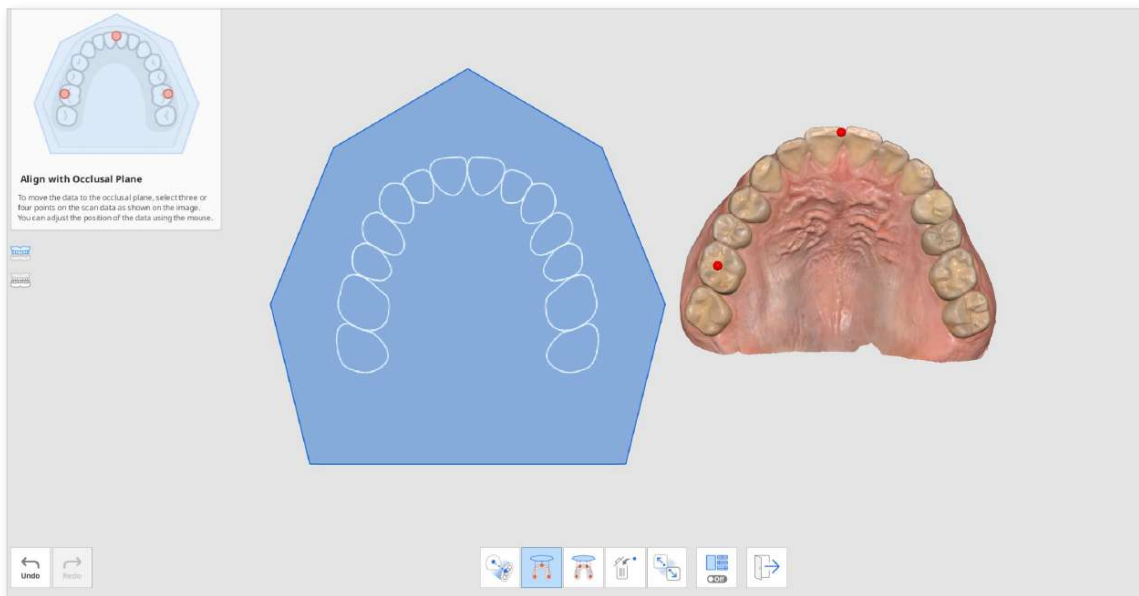

- ③ Move the arch data on the right side to adjust the position on the occlusal plane. The user can adjust it from different angles.

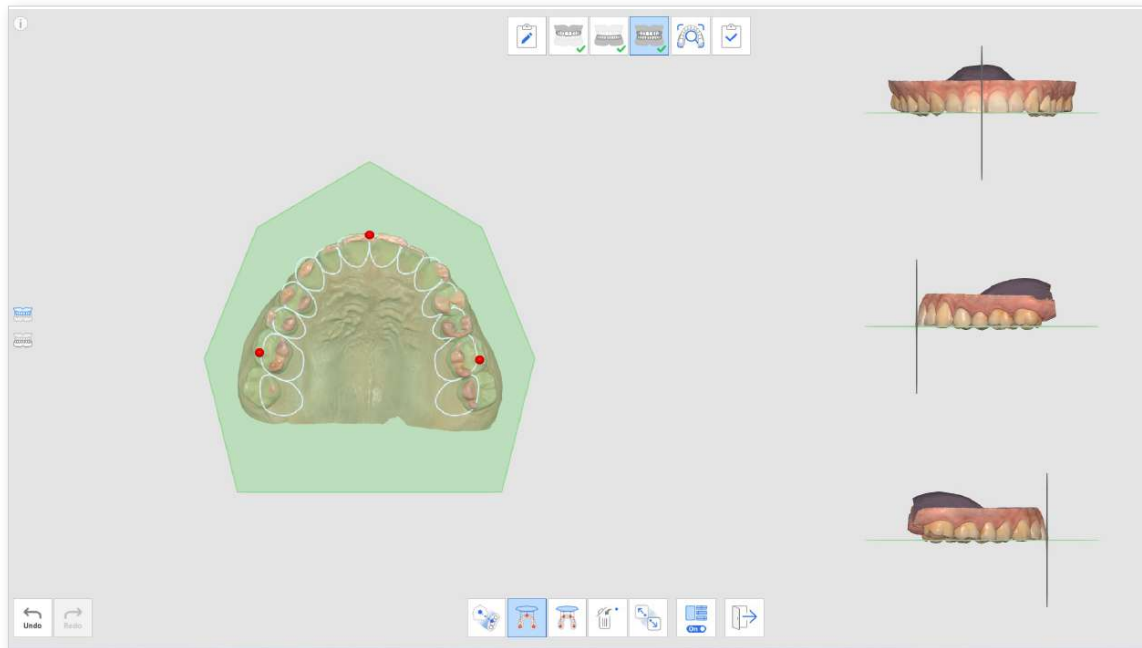

- ④ Select the maxilla, mandible, or both by using the buttons on the left. This allows the user to see the maxilla and mandible scan data individually or together.

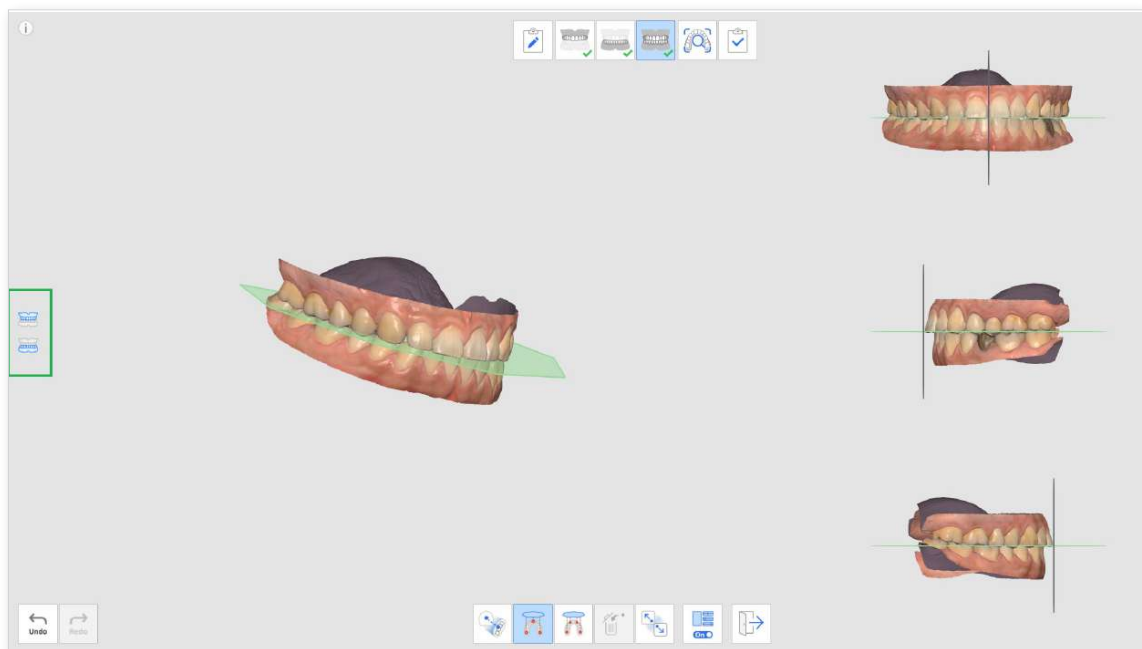

- ⑤ You can turn on or off the Multi-View feature.



- ⑥ When the data is loaded from exocad after completion, the scan data will be positioned at the same location as the virtual articulator.

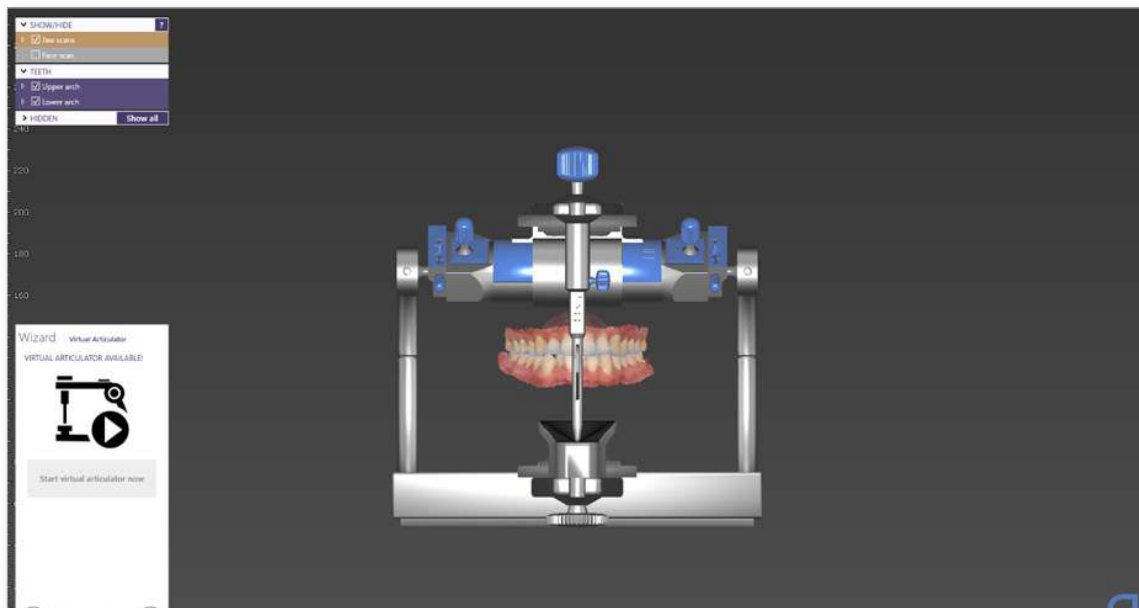

Mandibular Movement

To diagnose patients with acquired scan data, establish treatment plans, and make dental prostheses and devices, the mandible and the maxilla need to be aligned with each other. We have supported our users in aligning the mandibular and maxillary occlusion targets based on the first and the second occlusion data to show the positional relationships. However, it only presents the position of the maxilla and the mandible when they stay still without any motion.

We need to consider not only the center occlusion but also the mandibular movement of the patient caused by the TMJ motions to manufacture more accurate prostheses and devices. With this Mandibular Movement feature, you can record the actual movements of the mandible based on the maxillary data and use the simulation data for prosthetic manufacturing.

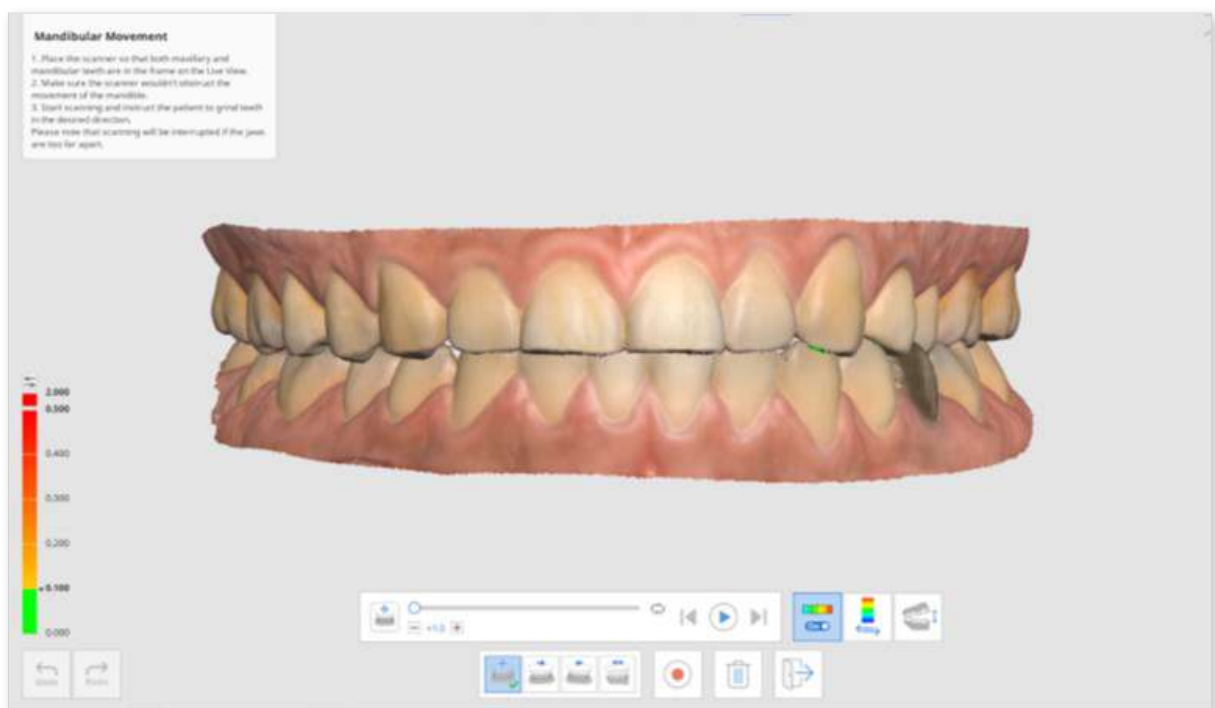

You can make a record of the following movements:

- Free Movement
- Left Lateral Movement
- Right Lateral Movement
- Protrusive Movement

After recording each movement, the mandibular movement can be reproduced by simulation. The color map facilitates identification of the interference area of the mandible and maxilla.

- ① Acquire maxillary and mandibular data in the Maxilar and Mandible stages.

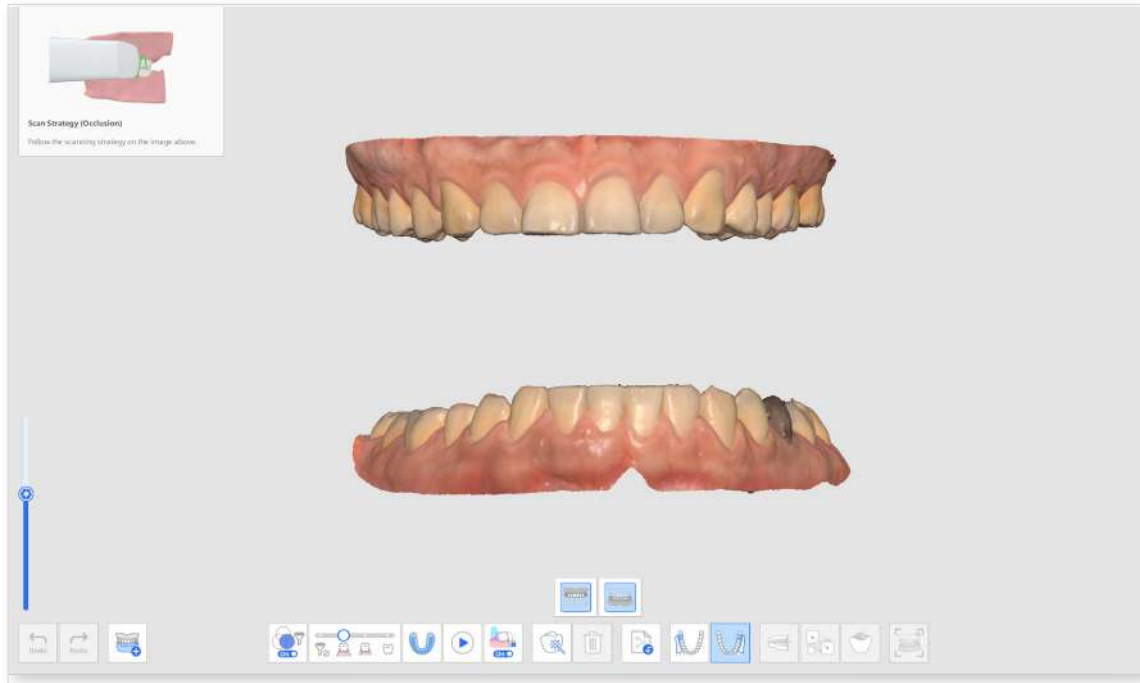

- ② Acquire the first (and the second) occlusion scan data in the Occlusion stage and proceed with alignment.

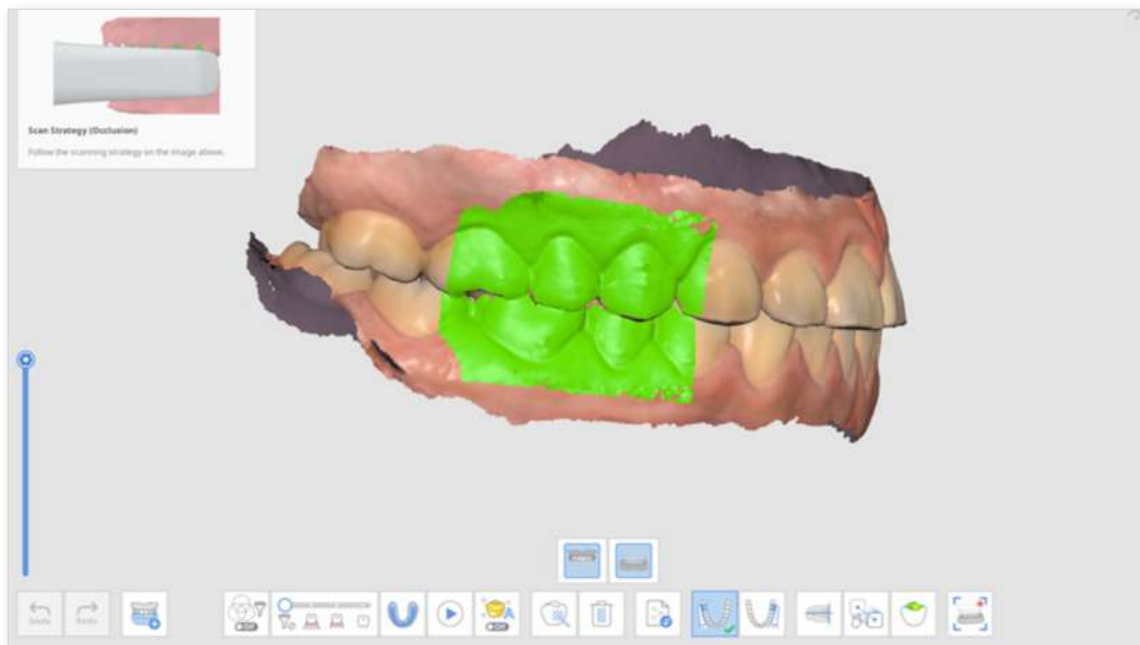

- ③ Click the "Mandibular Movement" icon at the bottom when activated.

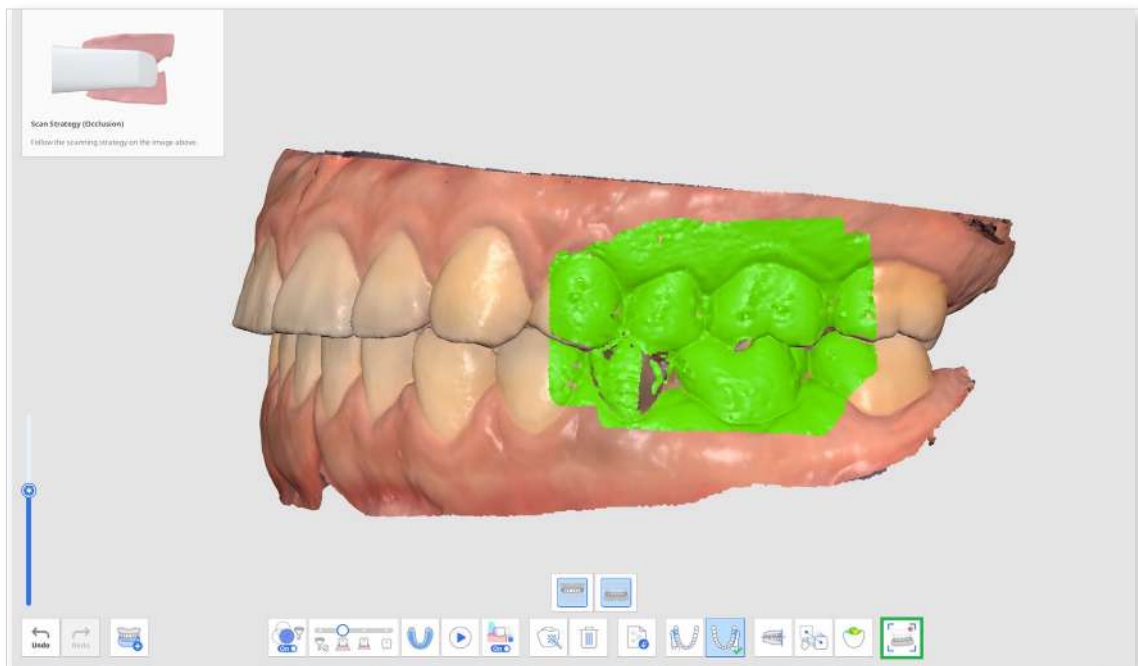

- ④ Select an icon of desired movement direction at the bottom from Free, Right Lateral, Left Lateral, and Protrusive.

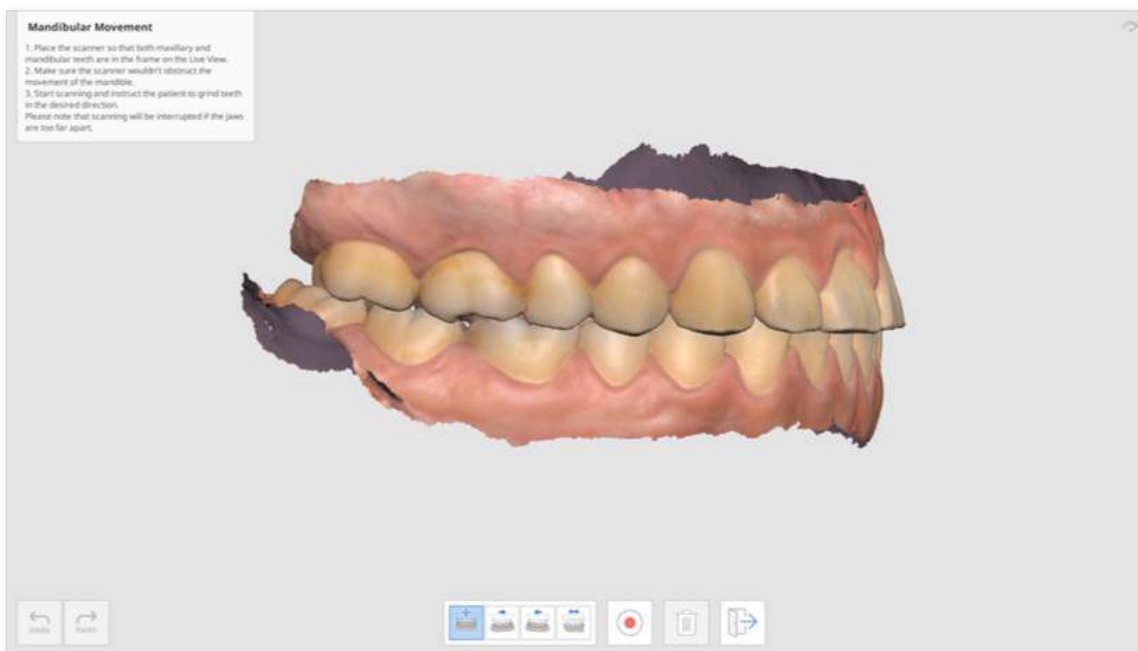

- ⑤ Place the scanner tip where the maxillary and mandibular meet while the patient keeps contact between the jaw.

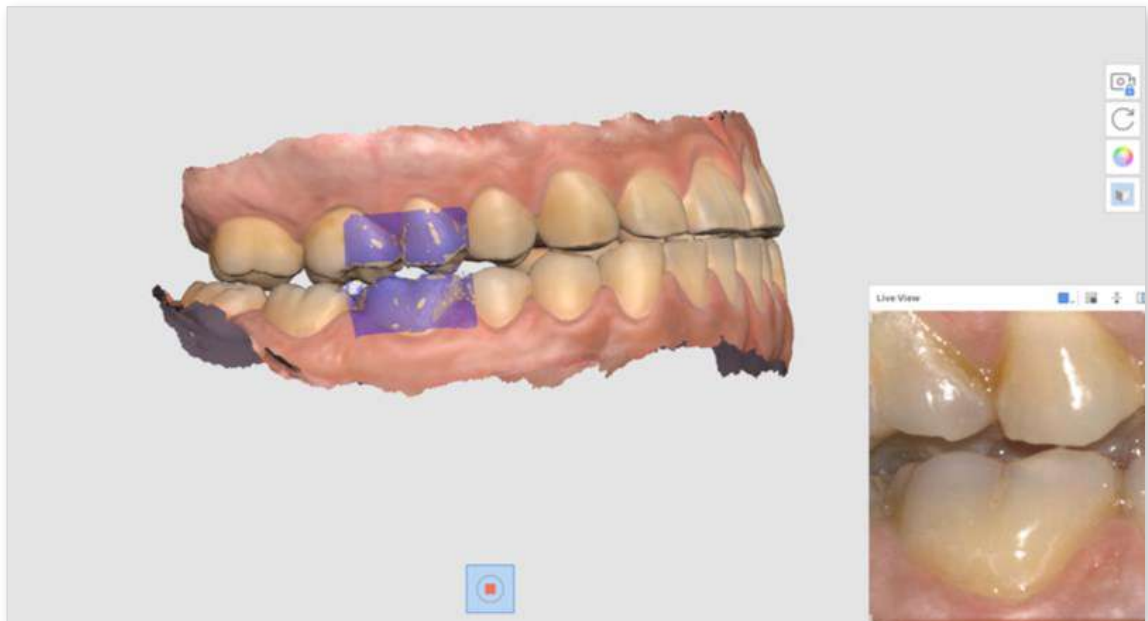

- ⑥ The Live View window appears on the screen when the scanner starts recording. Then, instruct the patient to move the mandible according to the selected movement direction. Make sure both the mandibular and maxillary teeth appear on the Live View. Scanning will be interrupted if the jaws are too far apart and the movement is no longer reflected on the screen.

- ⑦ The play bar and icons for mandibular movement simulation appear on the screen once you finish recording. You can play the movement recording by clicking the "Start" button. You can also adjust the speed of movement or turn on repeat.

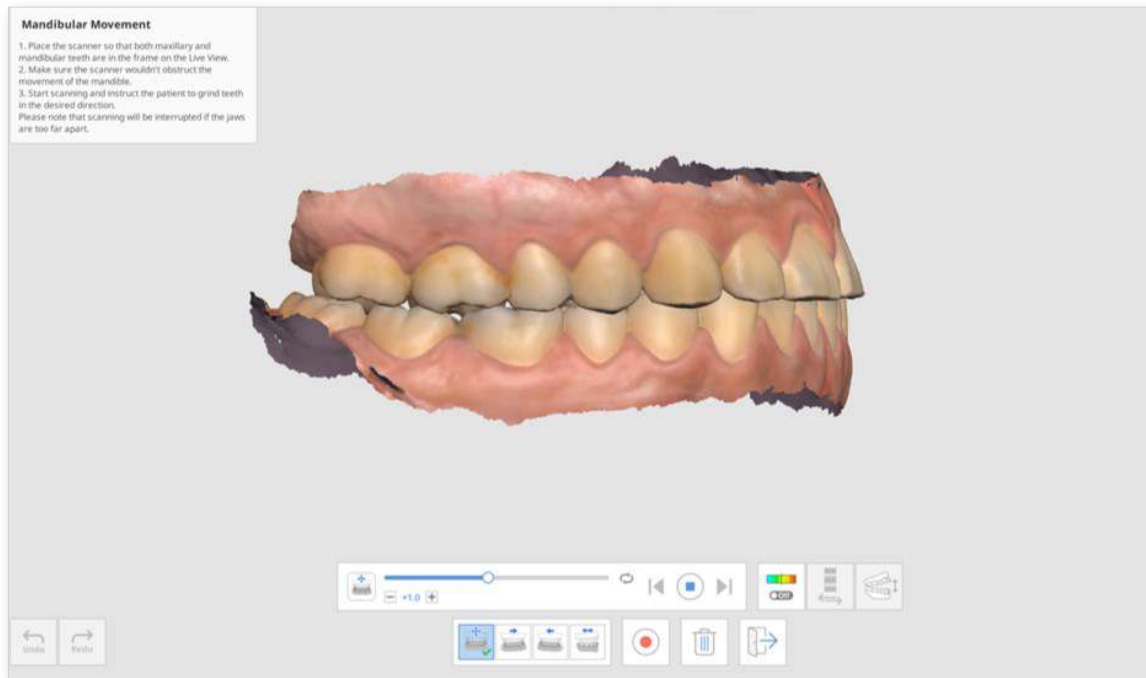

- ⑧ Click the "Deviation On/Off" icon to show or hide the interference areas while the mandible moves. Analysis to represent colors may take some time.

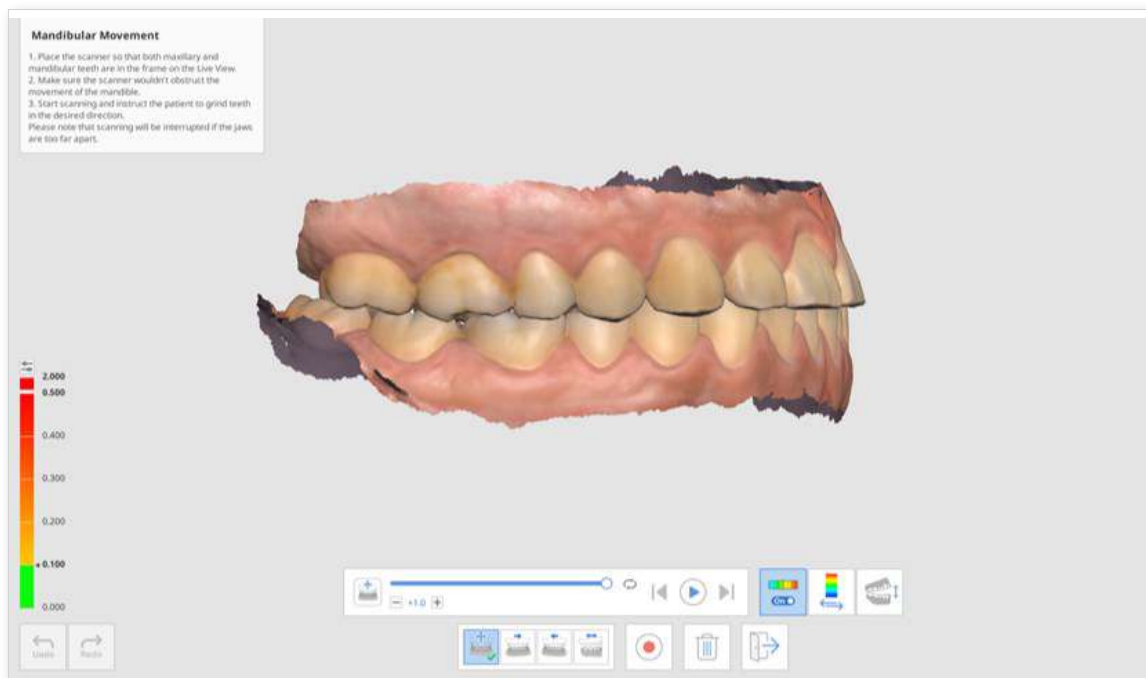

- ⑨ Click the "Switch Deviation Display Area" icon to display the scale for all data or contact areas only.

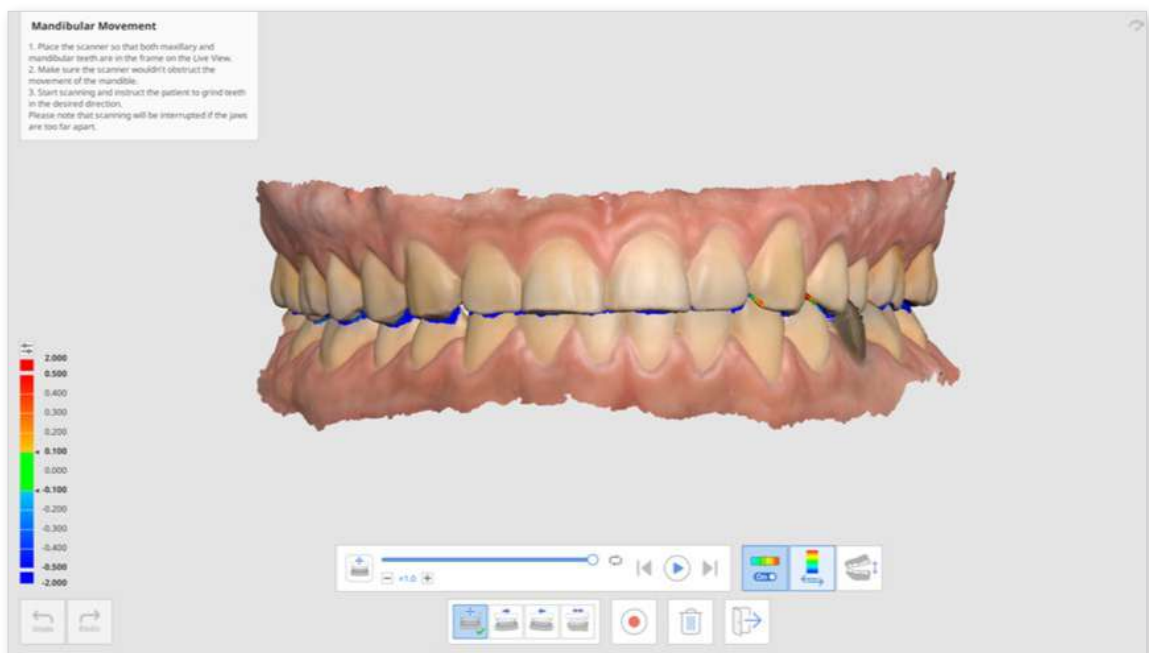
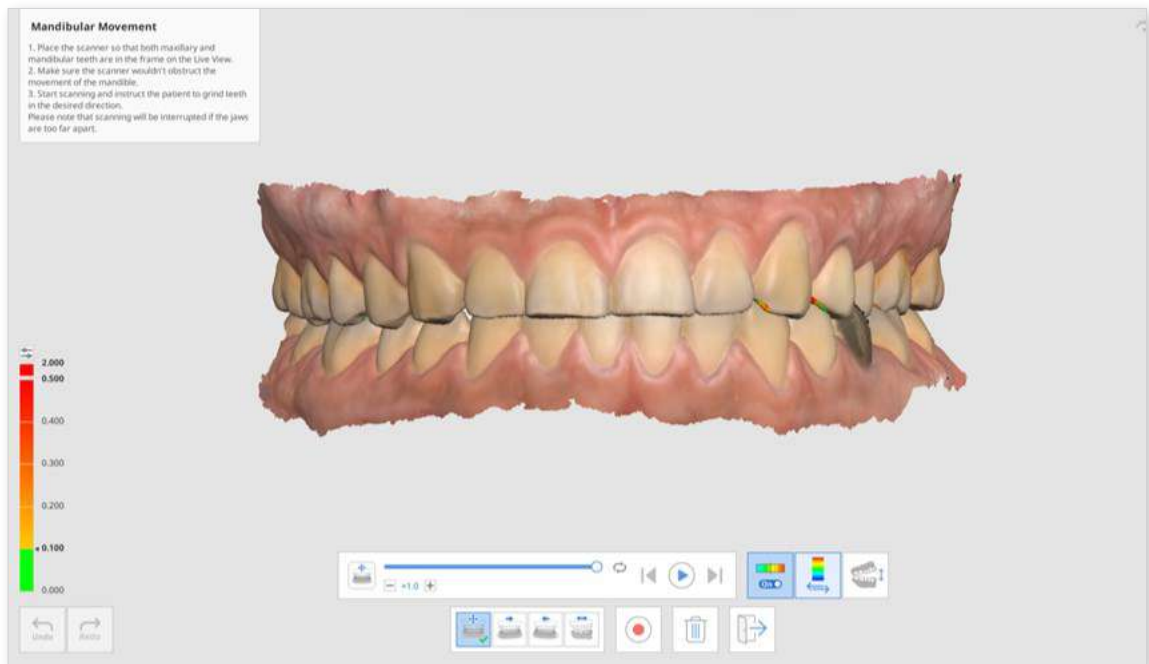

- ⑩ Click "Switch View" to change the view style between opened and closed jaws.

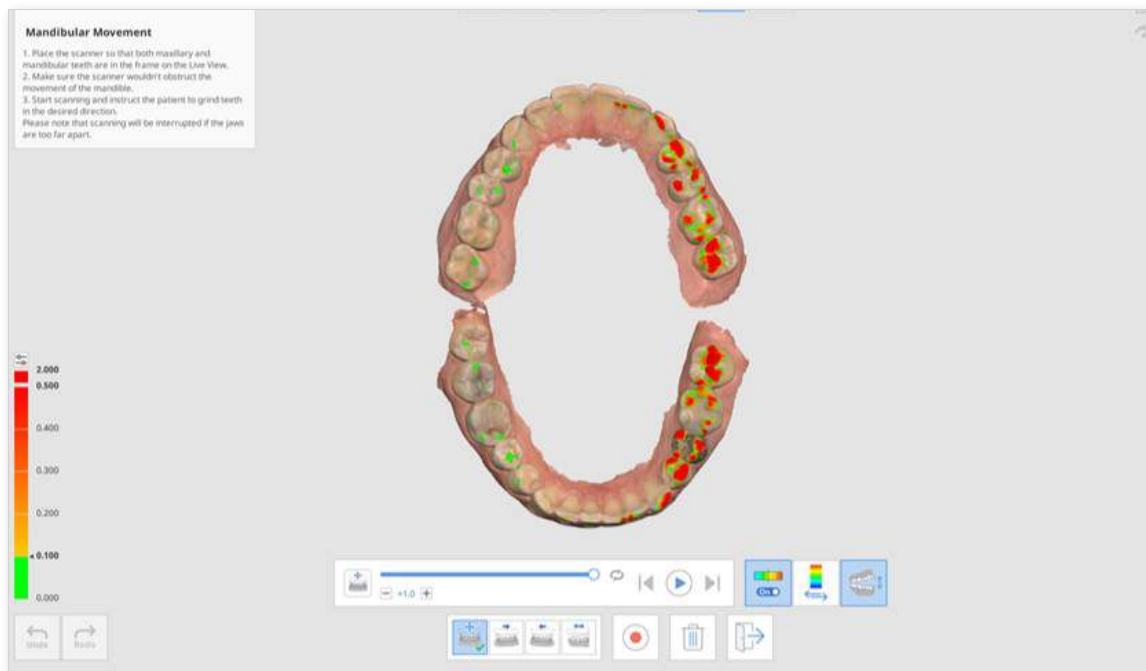
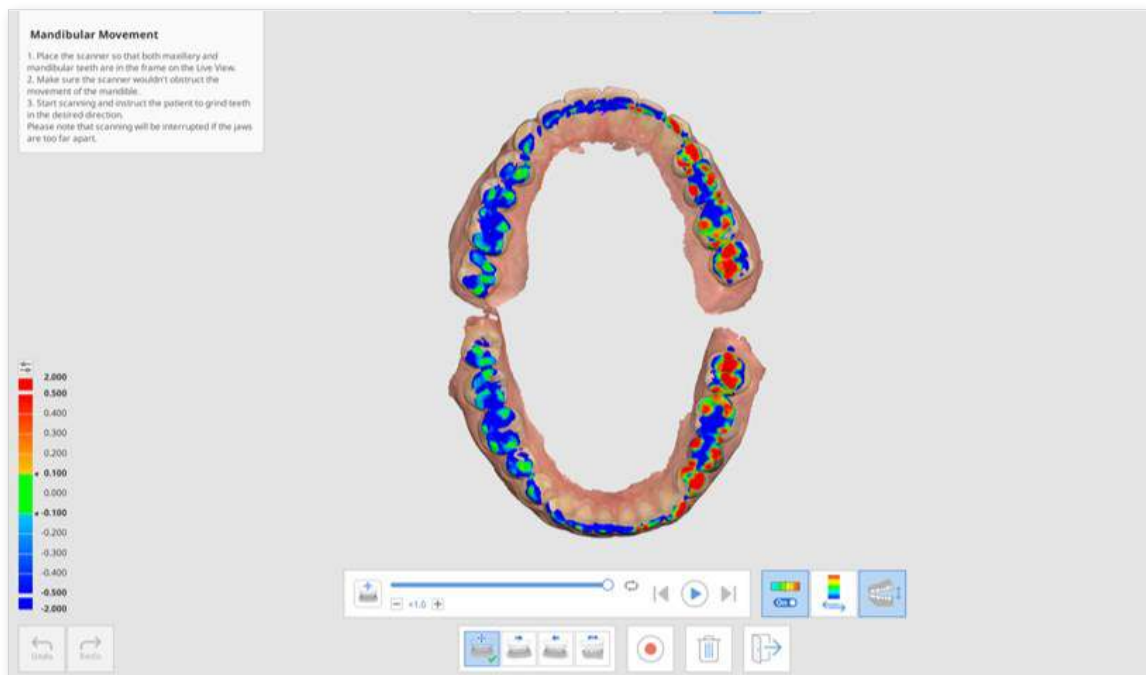

- ⑪ Click "Exit" to return to the Occlusion stage, and the mandibular movement recording will be added to the data tree in Medit Link.



Face

Face Stage

Caution

Face scans cannot be used for medical purposes such as simulation, diagnosis, or treatment and should only be used as a reference for prosthetic fabrication in a lab.





Acquire the scan data of teeth, mouth, nose, etc.



Additional Tools for Face Stage

Please refer to [Scan Stage Tools](#) for more information about how to use tools that appear at the bottom of the screen for each stage.

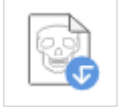
	Align Face Data	Select data and pick points on each of them for alignment.
	Import 3D Face Data	Import face data from an external source.
	Import 3D Bone Data	Import 3D face data taken by a CT scan. * DICOM file is not supported.

Additional Data

Additional Data Stage

	Acquire any additional data you need for the case. You can scan patients' existing restorations, temporary restorations, etc.
---	---

You can scan the outer surface of the patient's existing prosthesis or temporary prosthesis for the case.

- ① Add the Additional Data stage from Stage Management.

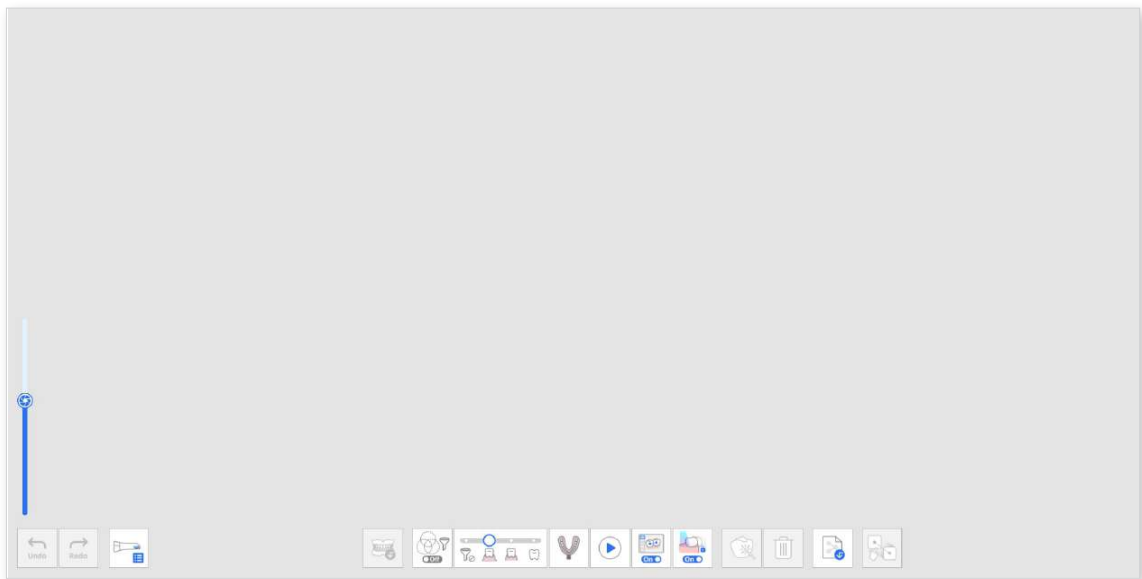

- ② Click the "Additional Data Group" icon at the bottom. You can add new data and delete or rename additional data on the list in the Additional Data Management dialog.

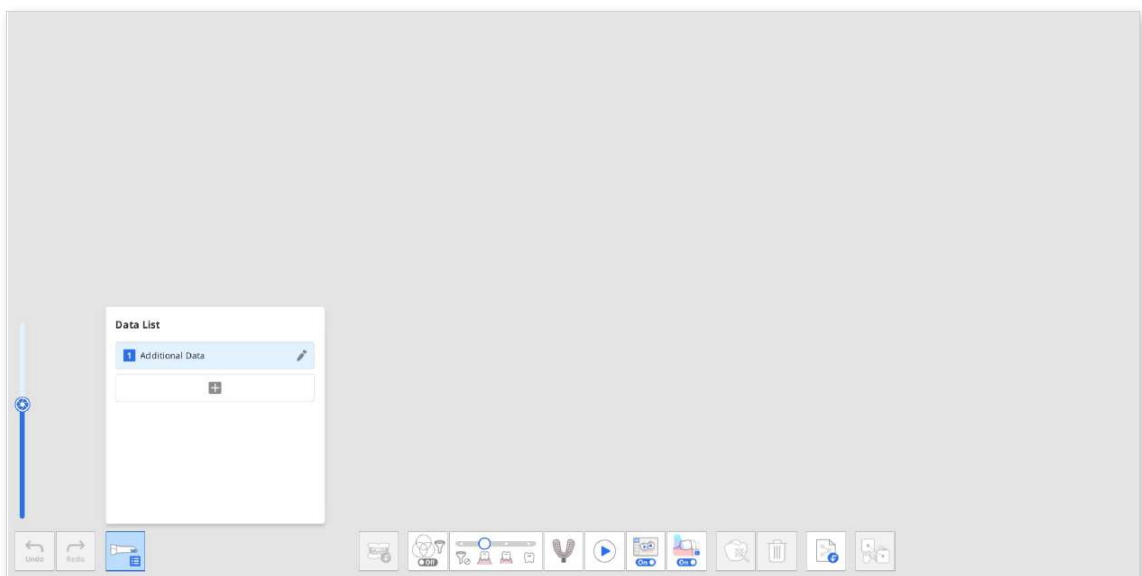

- ③ Acquire the first additional data.

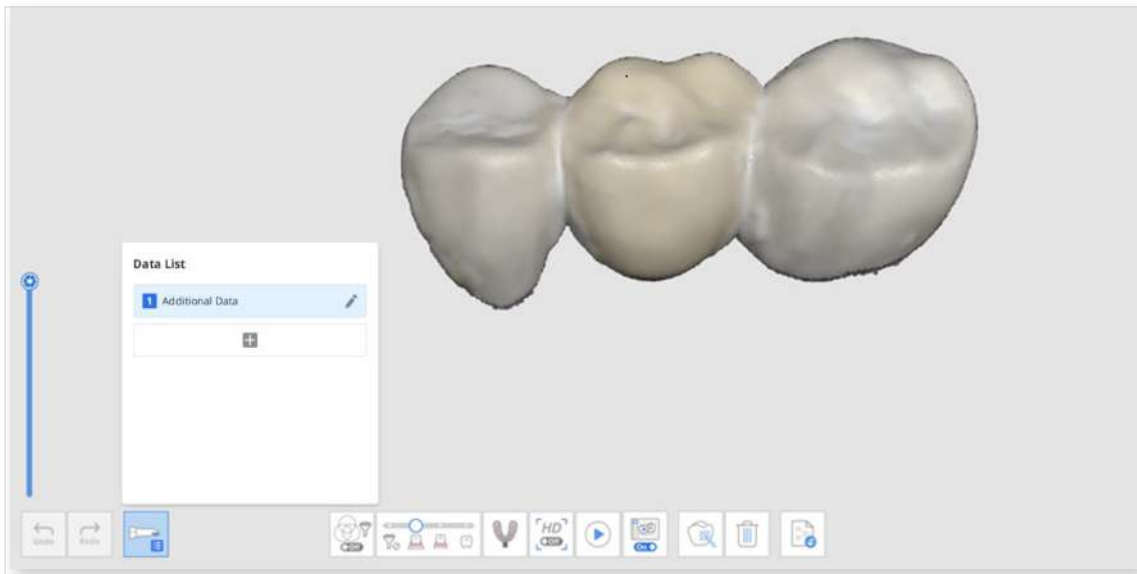

- ④ Click the "+" button on the Additional Data Management dialog and acquire another scan data for the added one.

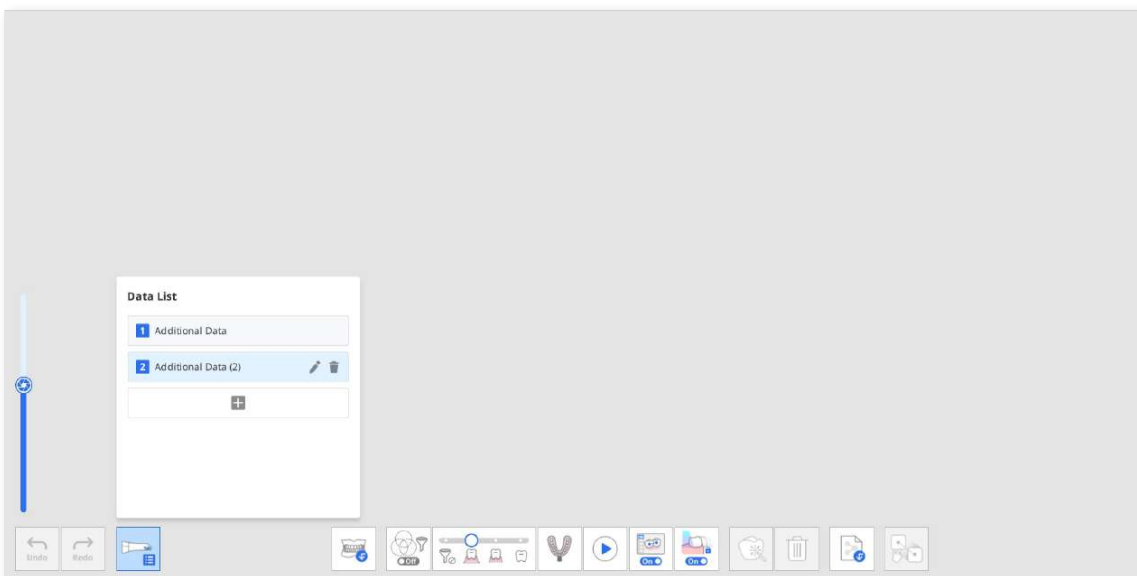

- ⑤ You can add up to seven additional data. You can also delete or rename the existing additional data from the list.

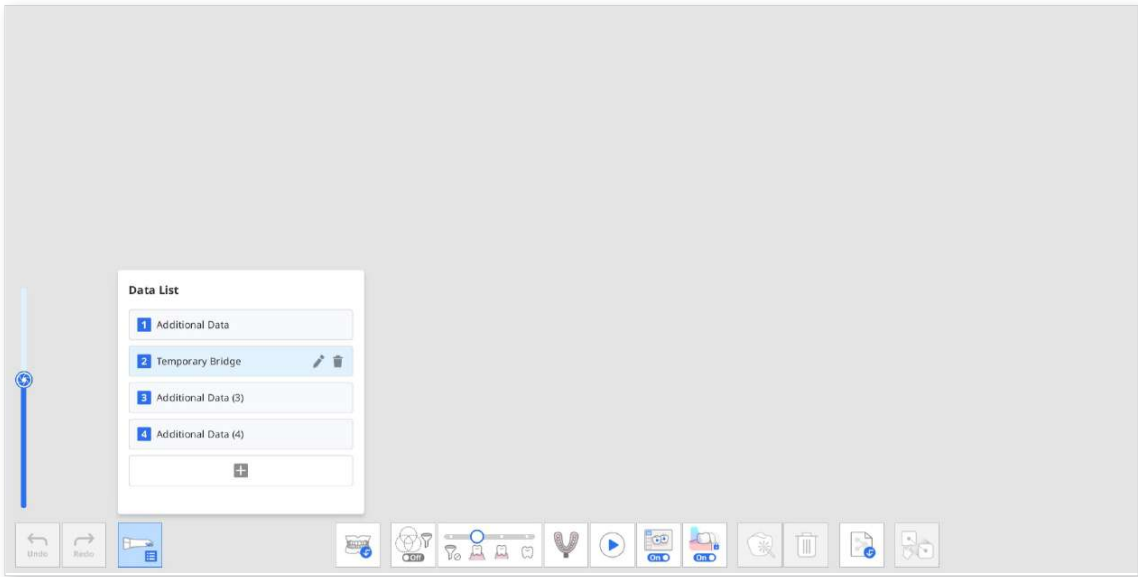

- ⑥ You can check the added additional data in the data tree on the Overview.

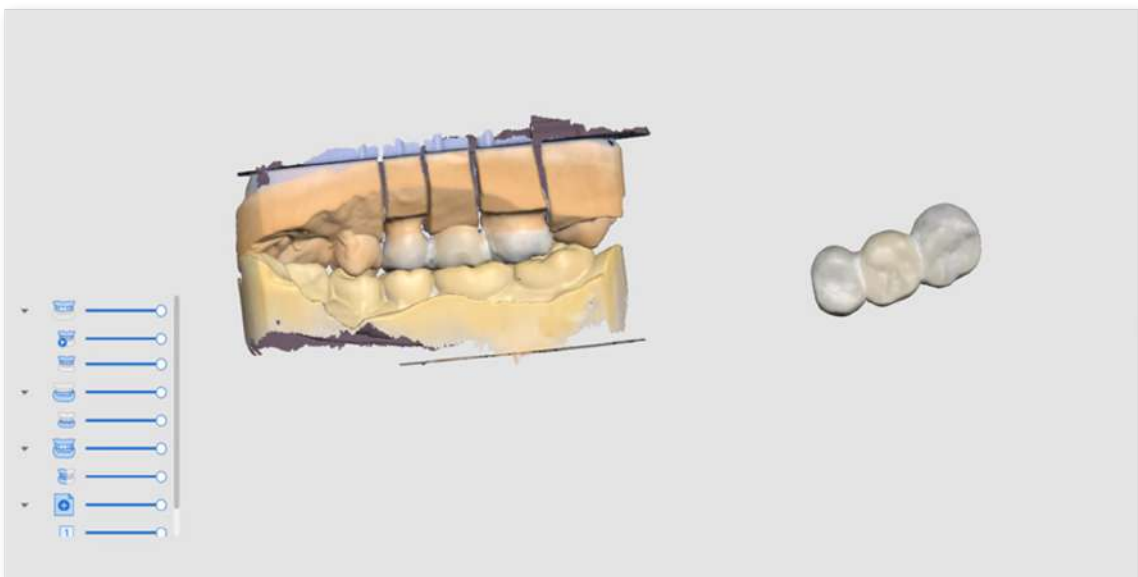

Smart Scan Review

Smart Scan Reive Stage

Note

- You can enable or disable the Smart Scan Review stage and set detailed options on Settings > Scan Data Analysis > Smart Scan Review.
- The Smart Scan Review stage is available for both default UI and simple UI.



Acquire any additional data you need for the case. You can scan patients' existing restorations, temporary restorations, etc.

The Smart Scan Review process follows the steps below:

Align with Occlusal Plane	You can position data in the occlusal plane. It is recommended to align the scan data to the occlusal plane, as this may affect the results of the subsequent tooth numbering.
Tooth Area Selection	The program automatically detects prepared teeth for crowns and their adjacent. You can use the selection tools at the bottom to manually select additional areas or modify the selected area.
Report Creation	You can see the report on the selected areas of prepared teeth and their adjacent teeth. You can also check the areas of implanted fixtures if selected in the Tooth Area Selection step.

Smart Scan Reive Report

In the Smart Scan Report, you can check the following:

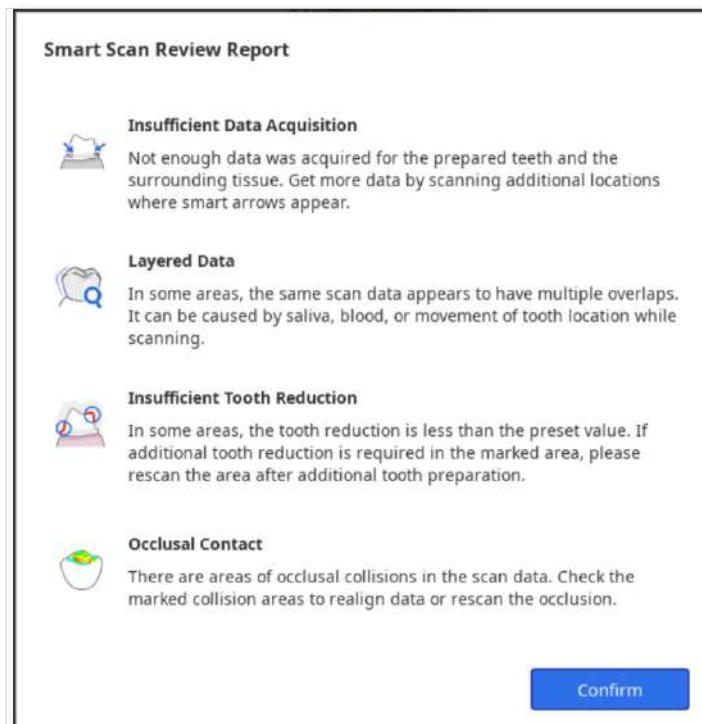









Insufficient Data Acquisition	Identify areas of insufficient scanning on prepared teeth and their adjacents.
Layered Data	Mark areas where multiple layers of data were created during the scan due to saliva or blood.
Insufficient Tooth Reduction	Check the tooth preparation and mark areas that need further tooth reduction for prostheses, such as crowns and copings.
Occlusal Contact	Mark areas of occlusal collisions or where the maxilla and the mandible are not in contact with each other, and check if both sides of occlusion data were acquired.

Tools for Smart Scan Review

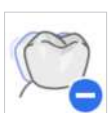
Note

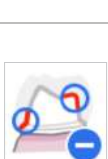
The Preparation Review tool is enabled only when form information is registered in the Medit Link > Form > Teeth tab.

The following tools are provided at the bottom of the screen to review the data:

Data Review Tools	Smart Arrows		Show smart arrows where data acquisition is insufficient.
	Layered Data		Mark areas where scan data has multiple overlaps due to saliva, blood, or movement of teeth.
	Remove Layered Data		Delete the marked areas of layered data.
	Preparation Review		Check whether the tooth preparation is done within the preset value range and mark areas that do not meet the set value range.
	Remove Data with Insufficient Reduction		Delete the marked areas of insufficient tooth reduction.
	Occlusion Analysis		Analyze interferences between the maxilla and mandible and show the analysis results with a color map.
Manual Alignment		Change the view between opened jaws and closed jaws.	
Show Report		Show the results of the smart scan review again.	

Smart Scan Review Process

- ① Acquire scan data in the Maxilla, Mandible, and Occlusion stages and align the occlusal data.

The Smart Scan Review stage is enabled when the following conditions are met:

- Occlusion scan data exists, and the occlusion data is aligned with scan data.
- If pre-op for maxilla or pre-op for mandible data exists, the pre-op data should be aligned with the maxillary or mandibular data.

- ② Click the "Smart Scan Review" stage.



- ③ The program automatically tries to align data to the occlusal plane in the Align with Occlusal Plane step. You can view the data from three different angles on the right side of the screen and manually adjust the data location.

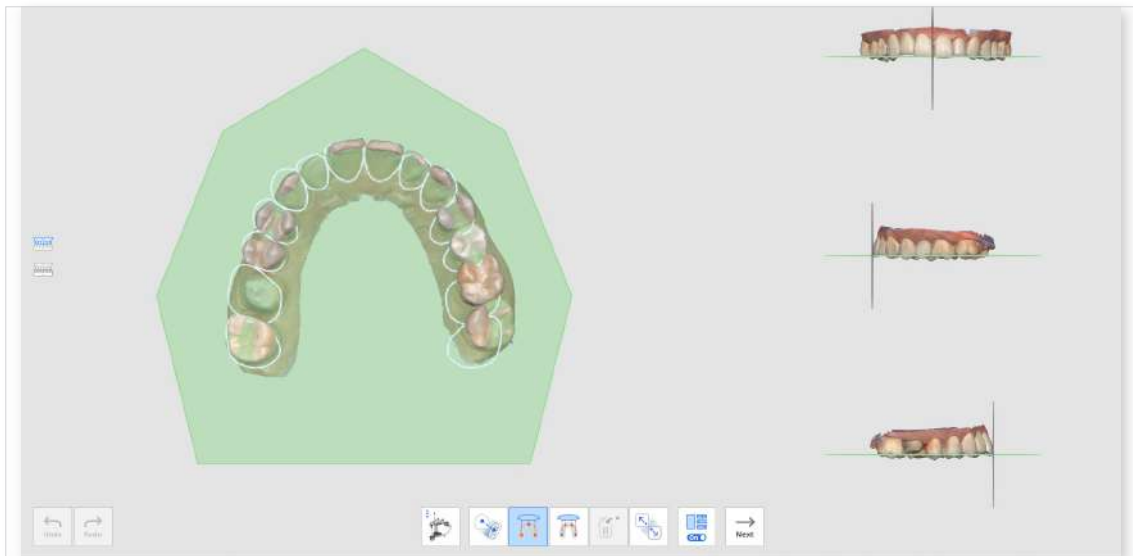

- If it fails to align, you can manually align the target data to the occlusal plane by clicking the 3 or 4 points on the occlusal plane.



- To align a half arch to the occlusal plan, select the "Half Arch Alignment" feature.



- ④ Once the data is aligned to the occlusal plane, click "Next" to move to the Tooth Area Selection step.
- ⑤ The program automatically selects areas for prepared teeth (for which products are registered in the Medit Link form) and their adjacent teeth. You can select more areas or modify the selection using the provided selection tools.



- ⑥ Click the "Next" button when it is enabled after selecting all prepared teeth areas.
- ⑦ The Smart Scan Review Report pops up, including the analysis results for the four items: insufficient data acquisition, layered data, insufficient tooth reduction, and occlusal contact.

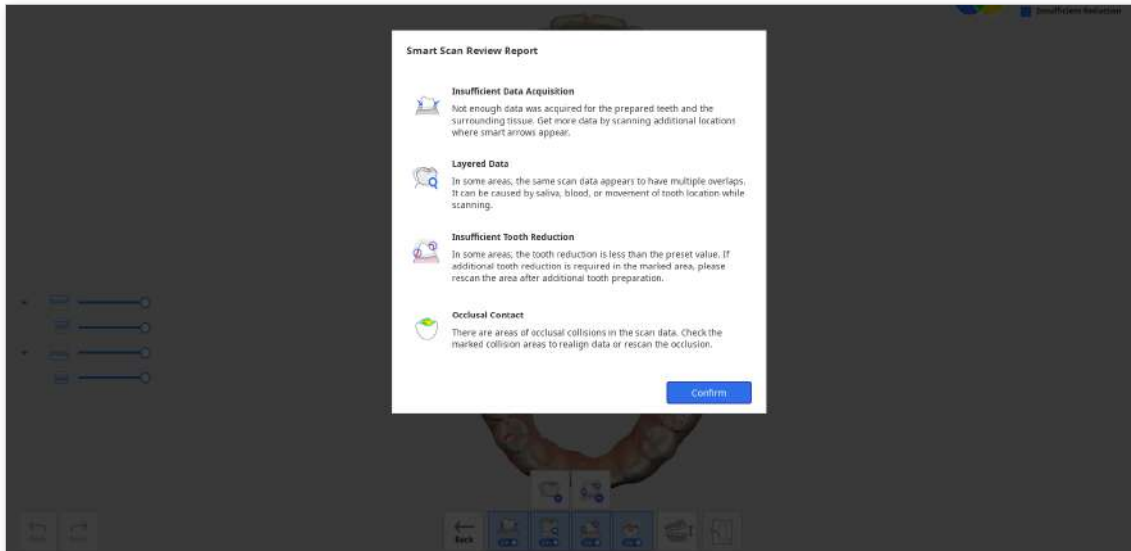

- ⑧ After reviewing the report, click the "Confirm" button to close the report.
- ⑨ You will see the scan data marked with different colors for results analyzed by each review tool provided at the bottom of the screen.



- You can switch views between the open jaw and closed jaws.
- You can view the report again by clicking the "Show Report" button at the bottom of the screen.
- The color information in the upper right corner of the screen allows you to see areas where problems may occur in different colors for different functions.



- ⑩ Refer to the color information on the top right of the screen and check the data where the data is colored.

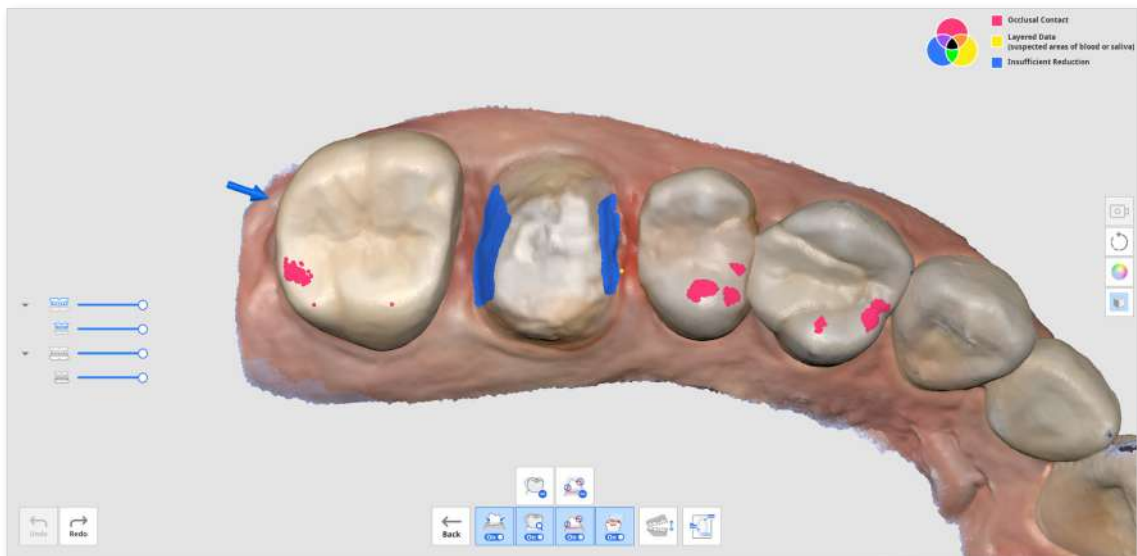

- ⑪ You can use the "Remove Layered Data" or "Remove Data with Insufficient Reduction" tools to delete the marked areas of layered data or insufficient tooth reduction
- ⑫ You can also return to other scan stages to scan additional data or trim and rescan if required.

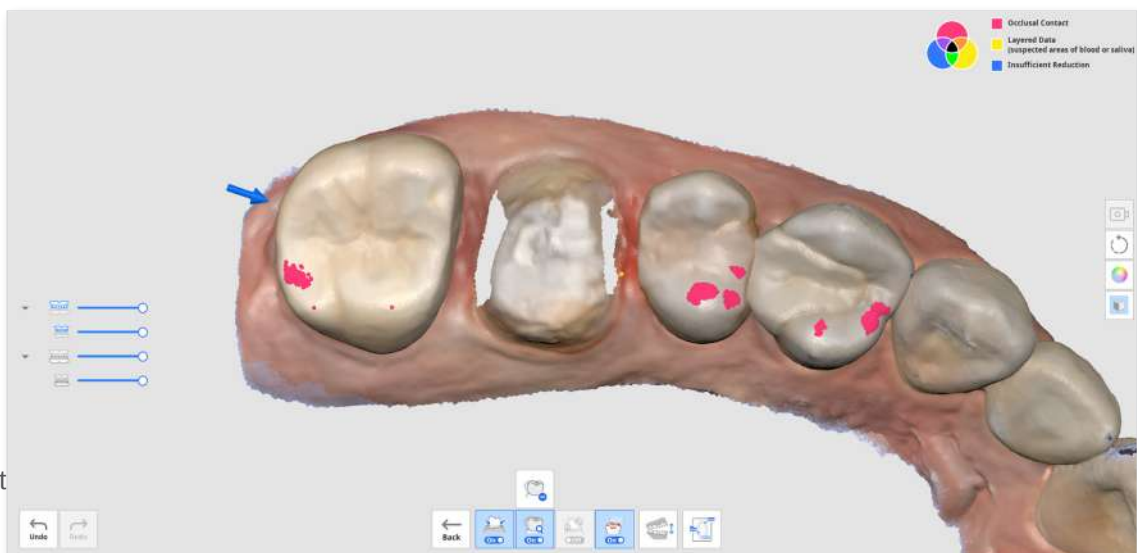

Complete

Complete Stage

	Complete the scan and generate the result data.
---	---

When you click the Complete stage icon, the following dialog appears to select how to process data.

Data processing will start.



Please check the following conditions before the data processing starts.

- All required scan stages are complete. [View More](#)
- There was no missing data while scanning the important and necessary areas. [View More](#)
- There was enough reliable data shown on the Reliability Map. [View More](#)
- Unnecessary soft tissues have been properly removed. [View More](#)

Please select the options.

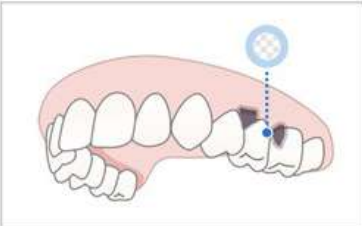

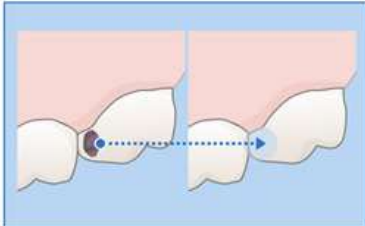

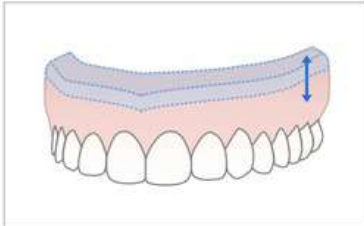



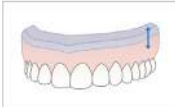

Cancel

Select one of the following options.

	<p>Process Data (As It Is)</p>	<p>Create optimized 3D digital models. The noise will be partly removed, and the areas with insufficient data will remain as empty spaces. You can adjust the file size and surface roughness in the settings if needed.</p>
	<p>Fill Major Holes</p>	<p>Use this option to fill all the major holes in the scan data. Based on the reliability map, it generates data for areas where data was not acquired by extending data with sufficient reliability.</p>
	<p>Create 3D Printable Model</p>	<p>Use this option to create a model for 3D printing. It expands the largest boundary to add thickness to produce a model with a flat bottom for 3D printing. You can adjust the file size and surface roughness in the settings if needed.</p>
	<p>Create Denture Replica Data</p>	<p>Use this option to create a model optimized for a 3D denture replica. The noise will be partly removed, and the areas with insufficient data will remain as empty spaces. You can adjust the file size and surface roughness in the settings if needed.</p>

If you select the "Create 3D Printable Model", the following dialog appears.

Create Model Base

Total Height 30 mm

Minimum Base Height

Hollow Model

Minimum Wall Thickness 3 mm

Cancel
Default
Confirm

Please refer to the following table and image and enter the value for height and thickness.

Total Height	Total height of the model, including the base
Minimum Base Height	Minimum height from the bottom of the base to the lowest point of the model
Minimum Wall Thickness	Minimum thickness of the model's inner wall

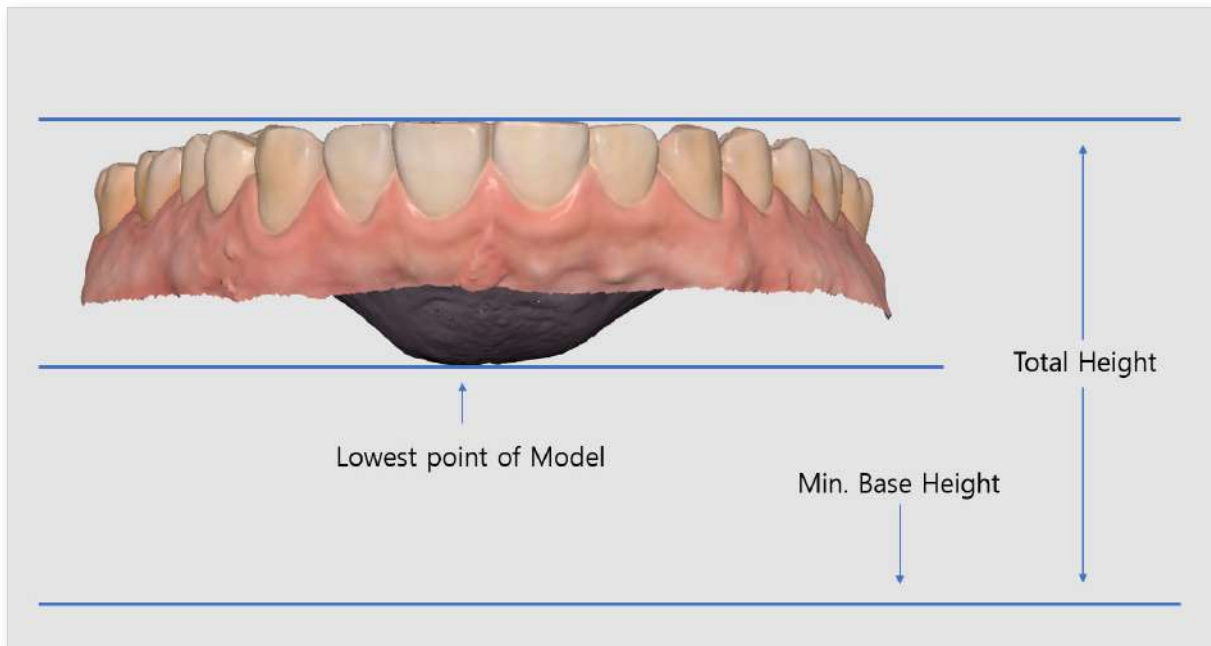







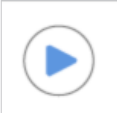

Tools and Functions

Scan Stage Tools

The following tools are provided at the bottom of each scan stage.



Basic Scanning Tools

	Start	Start the scan. The user can also start the scan by pressing the Scan button on the scanner.
	Stop	Stop the scan. The user can also stop the scan by pressing the Scan button on the scanner.
	Optimize	Align 3D images for a more accurate scan. All the noise will be removed after optimization.
	High Resolution Scan	Acquire high-resolution scan data for entire or partial scan data. The high-resolution and standard-resolution scan data are smoothly merged in post-processing. * unavailable with i600
	Import Scan Data	Import 3D data from Medit Link.
	Delete	Delete scan data for the current stage. All data that are related to the current stage can be deleted.
	Undo	Cancel the previous scan.
	Redo	Restore the canceled scan.

High Resolution Scan

* unavailable with i600

Please refer to the following comparison between the high-resolution and standard-resolution scan data,

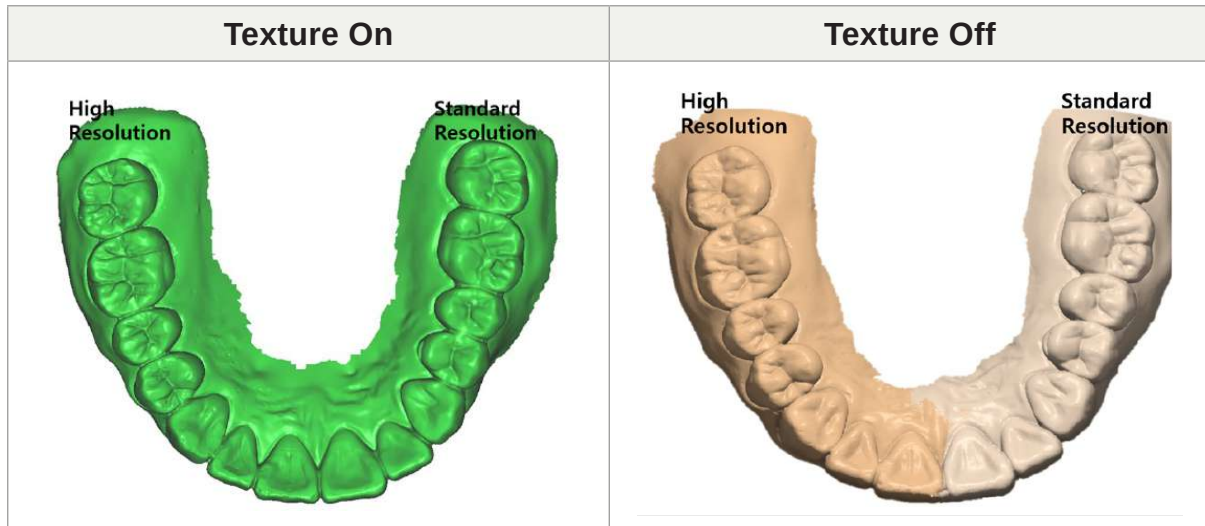

Note

You can set options for high-resolution data processing on Settings > Post-Processing > High-Resolution Data Processing.

- You can select whether to apply high-resolution data processing to only HD scan data or both SD and HD scan data.
- You can set to apply high-resolution data processing to prepared teeth data.

Import Scan Data

This feature allows the users to import scan data acquired by third-party scanners. You can edit the data or perform additional scanning with the imported data

Note

- You can import a previously scanned file from a case in Medit Link
- When importing a third-party scan file, make sure to attach it to a case in Medit Link before proceeding.
- You can import a file before starting the scanning process or moving on to the next stage.

① Click the "Import Scan Data" icon.

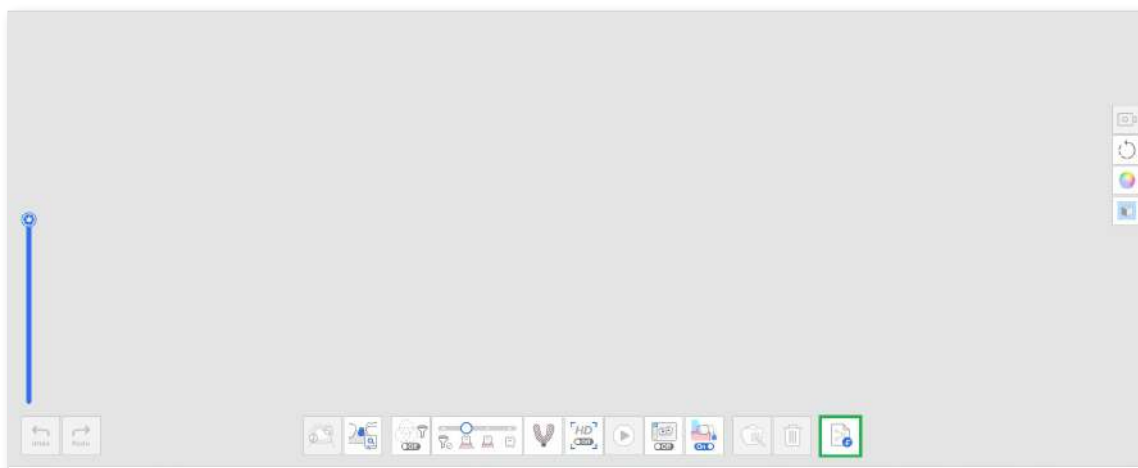

② Choose a file from a Medit Link case.

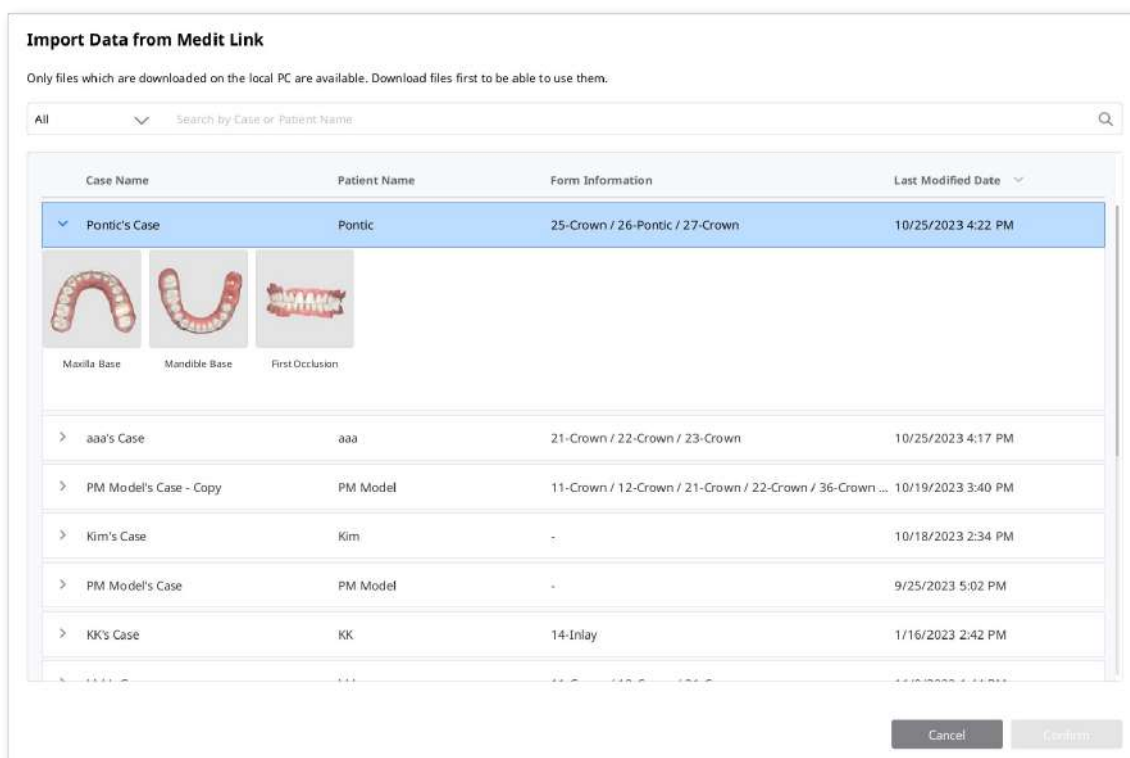



- ③ Trim the part needing a rescan.

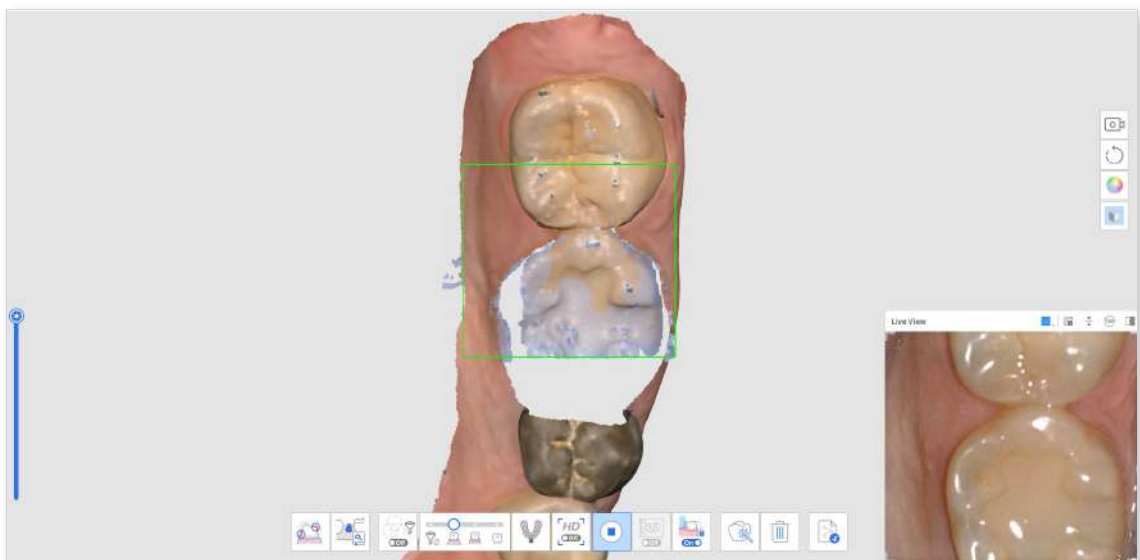

- ④ Perform addition scanning.







Filtering Tools

	<p>Smart Scan Filtering</p>	<p>Filter unnecessary soft tissue data while scanning. Three filters are available for Smart Scan Filtering.</p> <ul style="list-style-type: none"> • No Filtering • Teeth + Gingiva • Intense Teeth + Gingiva • Teeth
	<p>Smart Color Filtering</p>	<p>Filter specific colors from being scanned. You can add and manage the color to filter.</p>
	<p>Smart Stitching</p>	<p>Acquire and align scan data freely, regardless of your scan strategy. Data is automatically aligned while scanning and can be manually aligned after scanning stops.</p>

Smart Scan Filtering

This feature removes unnecessary soft tissue data while scanning, depending on the selected filter. Three filters are available for your convenience.

	<p>No Filtering</p>	<p>Soft tissue remains intact. This option is useful for edentulous arch or plaster model cases.</p>
	<p>Teeth + Gingiva</p>	<p>Remove soft tissues that interfere with the scan, leaving only the necessary teeth and gingiva. You can use this option for most of the general scan cases.</p>
	<p>Intense Teeth + Gingiva</p>	<p>Remove soft tissues that interfere with the scan, leaving only the necessary teeth and gingiva. This option only acquires gingiva data within a certain distance from the tooth and excludes other soft tissues away from the teeth.</p>
	<p>Teeth</p>	<p>Remove all soft tissues and gingiva, leaving teeth only. This option is effective when scanning only the teeth as an additional scan after using the "Teeth + Gingiva" filter for initial scanning.</p>

Smart Color Filtering

The "Smart Color Filtering" option prevents the scanning of alien materials (e.g., gloves, etc.) in the intraoral environment by registering their colors. Once the colors are registered, and the option is turned on, the colors will automatically be filtered out during the scanning process.

- ① Turn on filtering by clicking the "Smart Color Filtering" option at the bottom.



- ② To register a new color, click the "Add a Color" icon.



- ③ The Smart Color Filtering dialog appears.

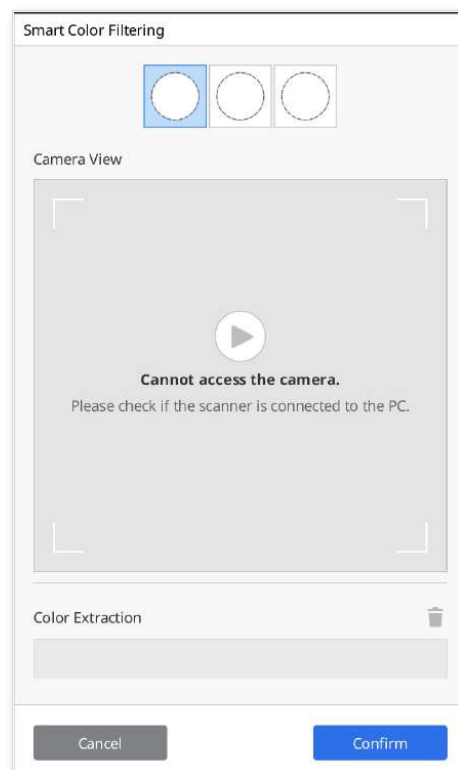

- ④ Prepare the material to be filtered out. Then, press the Scan button on the scanner to start the color recognition process.

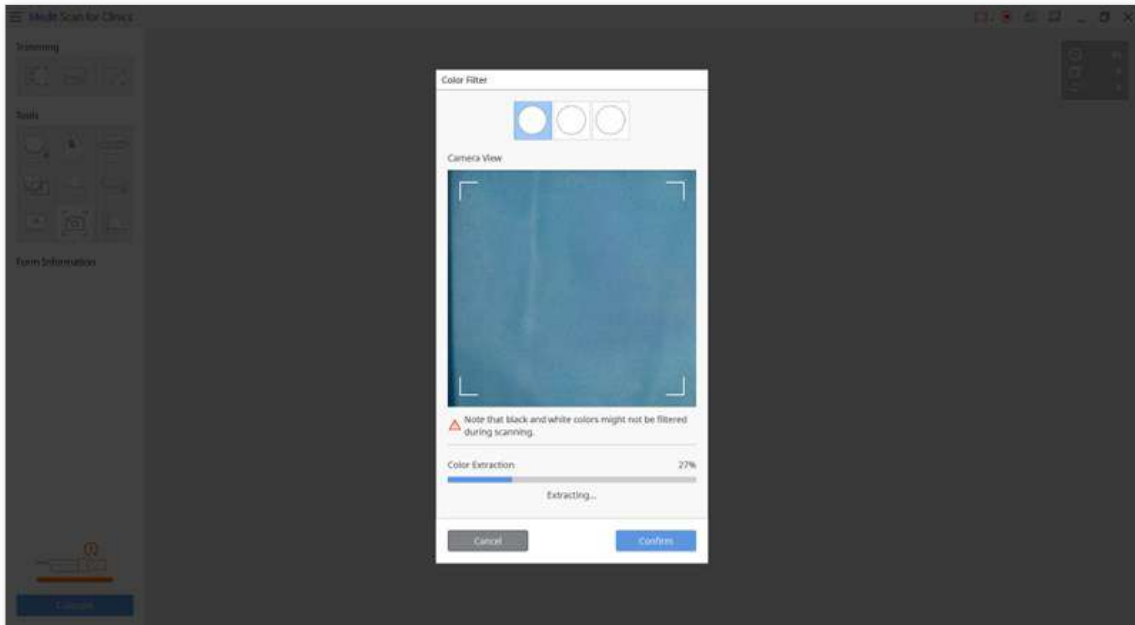

- ⑤ Click "Confirm" to register the color and complete the color registration.
- ⑥ You can turn on or off each color filter by clicking the color icons.

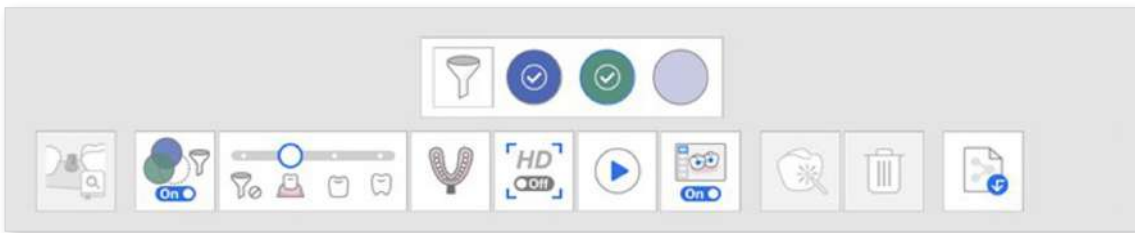

- ⑦ The registered colors will be shown on the icon and saved for all scan stages unless you change them.



Smart Stitching

Note

- Smart Stitching is only supported for the Pre-Op for Maxilla, Pre-Op for Mandible, Maxilla, and Mandible stages.
- Smart Stitching is unavailable for the Abutment Library Matching, Impression Scan, and Relined Denture Scan tools.
- You cannot use Smart Stitching after using Abutment Library Matching, Scan Body Library Matching features or after occlusion alignment.

For 3D scanning using the video recording method, it is important to scan continuously so that the camera does not lose focus during the process of acquiring scan data.

This process is highly dependent on the user's skill and the condition of the patient's mouth, but the scanning method supported by Smart Stitching can eliminate this inconvenience.

- ① Turn on the "Smart Stitching" icon at the bottom.

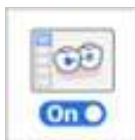

- ② Start scanning in the stage that supports Smart Stitching, Pre-Op.

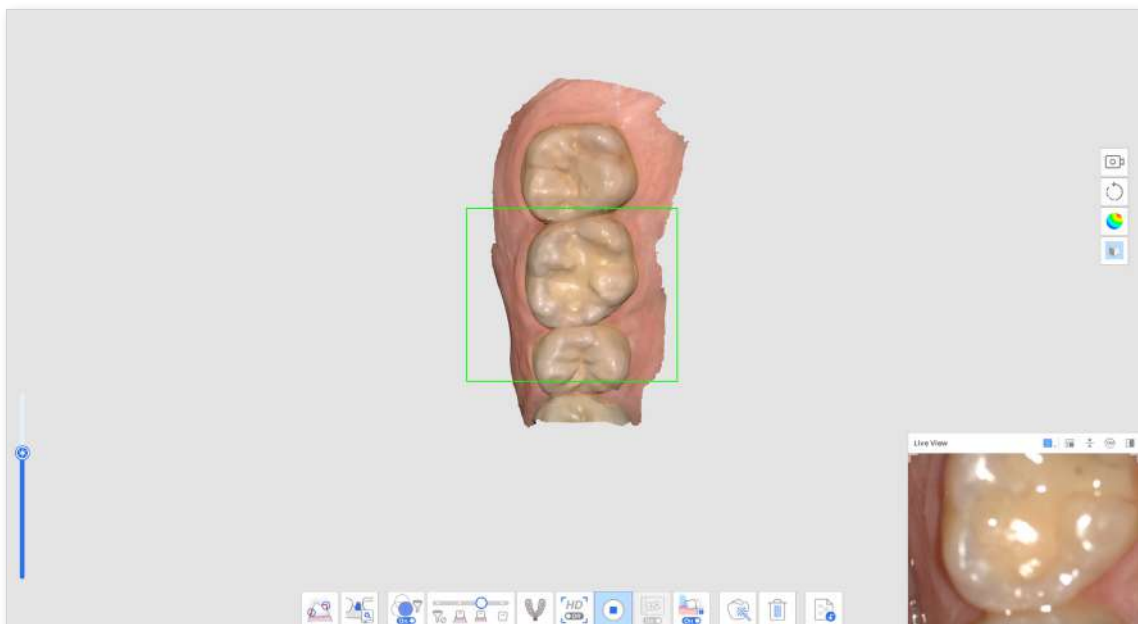

- ③ When the scanner is placed in a non-contiguous area with the acquiring scan data, new scan data will be acquired. At this time, the previously scanned data is displayed as a thumbnail in the lower left corner.

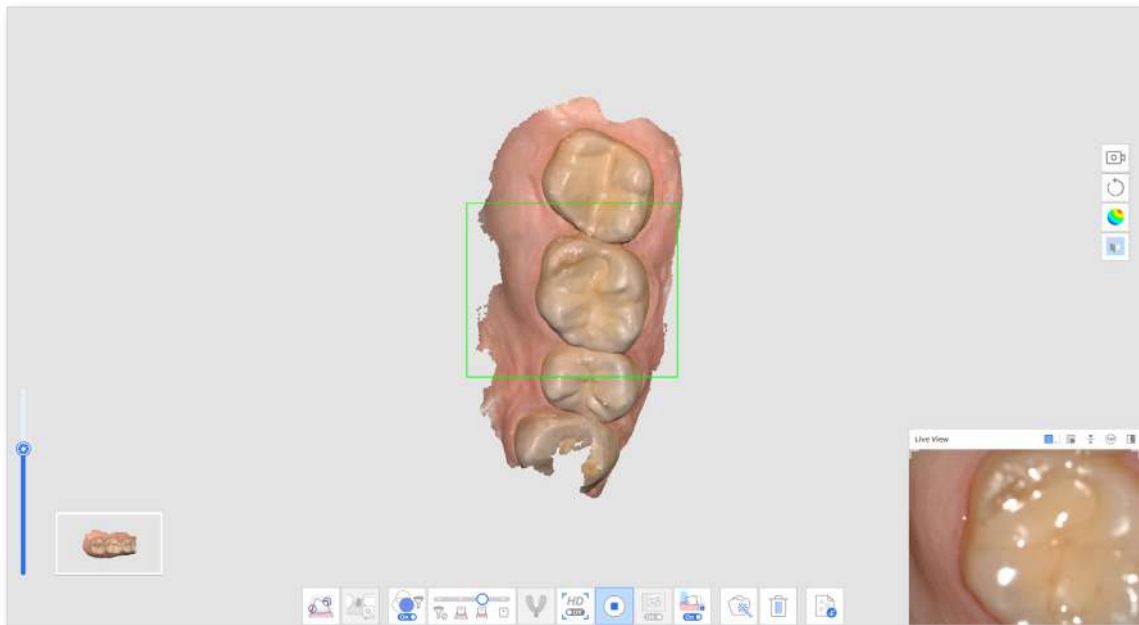

- ④ On the left corner of the screen, you can have up to five thumbnails of the previous scan data.

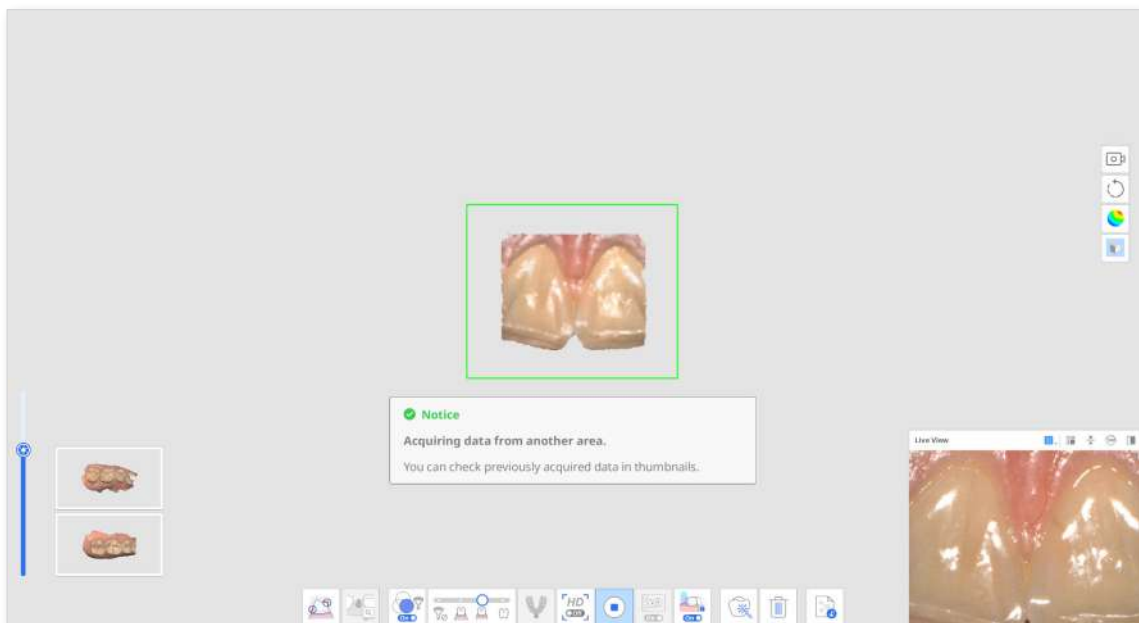

- You can click each thumbnail to view the data at the center of the data display area, and the previously displayed data is added to the thumbnails.

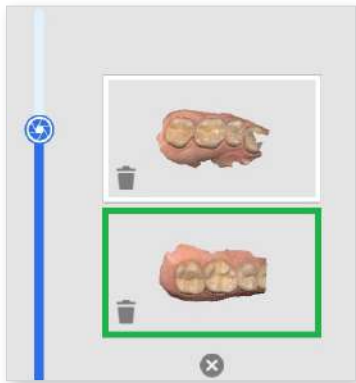

- You can click the trash icon on each thumbnail to delete each one of them or the "x" button at the bottom of the thumbnail list to delete all thumbnails.

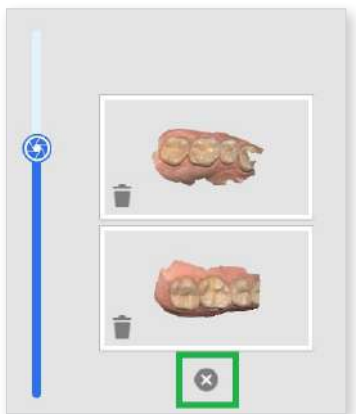
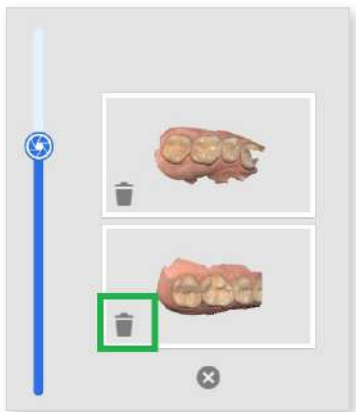

- During scanning, if the scanner gets new data in an unaligned scan data area, it will automatically attempt to align, and any thumbnails of aligned data will disappear.

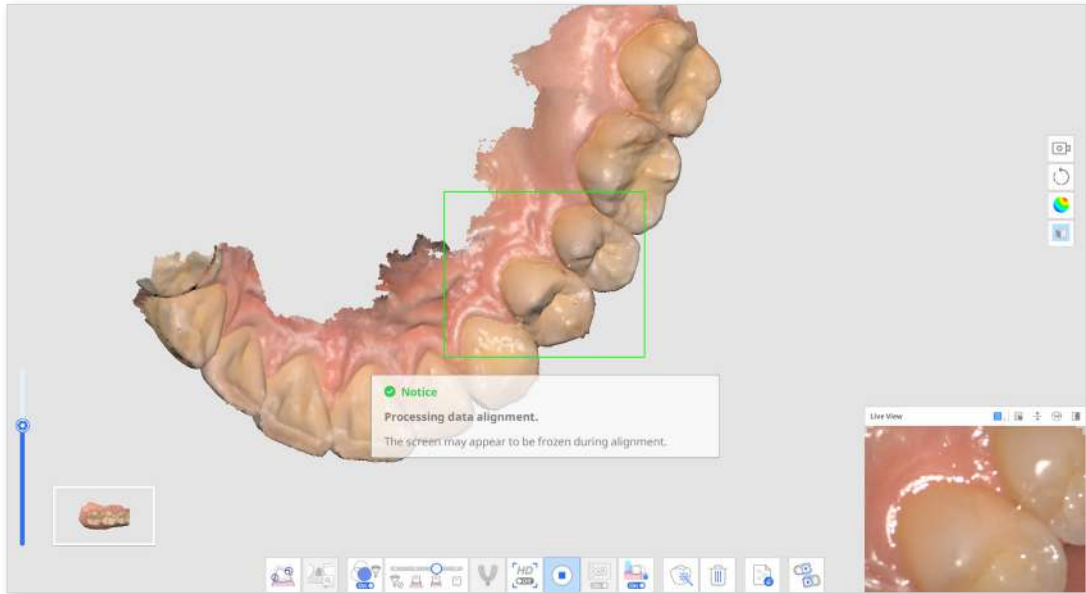



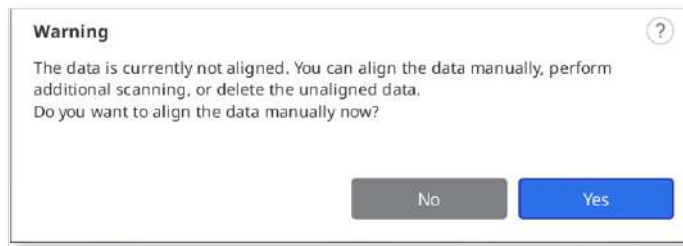

- ⑥ The following message may appear when you try to exit the stages when unaligned scan data exists.

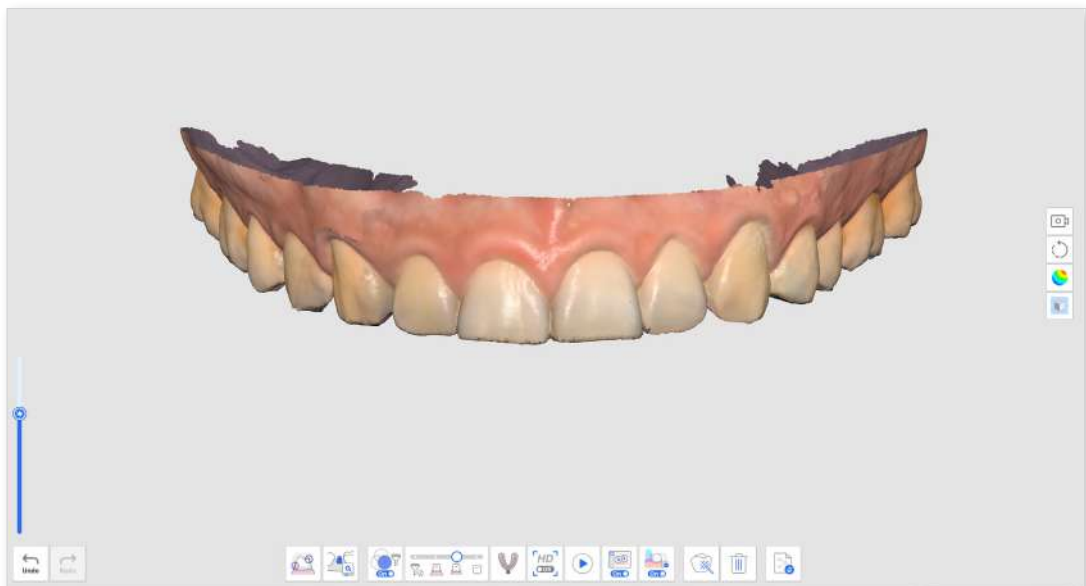

- ⑦ To align all scan data, conduct one of the following:
- Scan additional data to get more data for automatic alignment.
 - Use the Manual Alignment tool to align data.
 - Delete all or part of the scan data that isn't aligned.
- ⑧ Data acquisition is completed when all unaligned scan data is aligned, as shown below.





Advanced Tools

	<p>Impression Scan</p>	<p>Provide seamless scanning to combine intraoral and impression scan data.</p> <p>Merge the intraoral and impression scan data with the integrated scan.</p> <p>* Refer to Case and Workflow Examples > Impression Scan for a detailed description of how to use the tool.</p>
	<p>Abutment Library Matching</p>	<p>Manage custom abutment libraries.</p> <p>This library data is aligned automatically with the scan data, minimizing the need to scan difficult-to-reach areas.</p> <p>* Refer to Case and Workflow Examples > Abutment Library Matching for a detailed description of how to use the tool.</p>
	<p>Scan Body Library Matching</p>	<p>Manage pre-set and custom scan body libraries.</p> <p>This library data is aligned automatically with the scan data, minimizing the need to scan difficult-to-reach areas. The library data can be shared for further processes, such as design.</p> <p>* Refer to Case and Workflow Examples > Scan Body Library Matching for a detailed description of how to use the tool.</p>
	<p>Mandibular Movement</p>	<p>Record and replay the patient's mandibular movement.</p> <p>* Refer to Scan Stages > Occlusion > Additional Tools for Occlusion Stage > Mandibular Movement for a detailed description of how to use the tool.</p>
	<p>Preparation Review</p>	<p>Check whether the tooth preparation is done within the pre-set value range.</p> <p>You can check the prepared tooth data with insertion path and distance measurements.</p> <p>* Refer to Case and Workflow Examples > Preparation Review for a detailed description of how to use the tool.</p>

Main Toolbar Tools

Trimming Tools

Trimming tools help to edit and remove noise from the data.

	Polyline Trimming	Remove all entities within a polyline shape drawn on the screen.
	Brush Trimming	Remove all entities on a freehand-drawn path on the screen. Only the front face will be selected. The brush comes in three different sizes.
	Quick Trimming	Remove data detached from the rest of the data quickly.

Polyline Trimming

- ① Click the "Polyline Trimming" from the Trimming tool on the main toolbar.



- ② Draw a polyline around the area you want to delete in the 3D data.

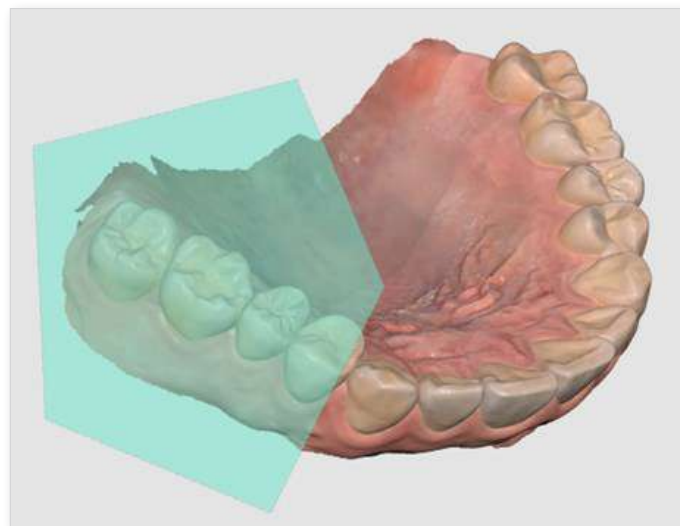



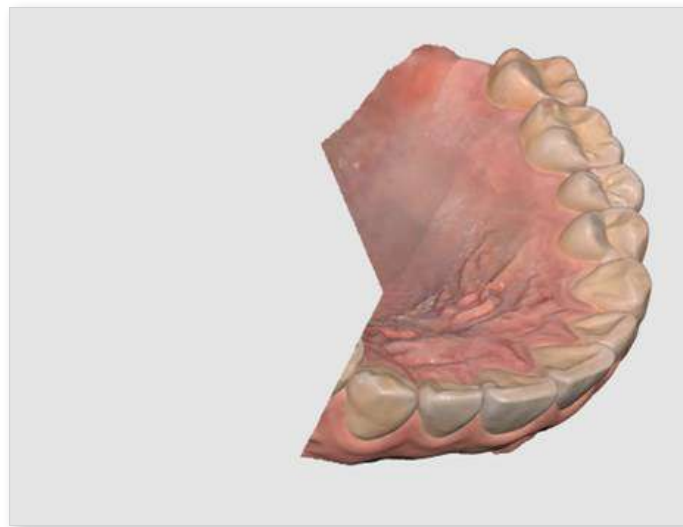

- ③ Delete the selected region by right-clicking on the mouse.



Brush Trimming

With Brush Trimming, you can remove all entities on a freehand-drawn path on the screen. The following tools are provided at the bottom of the screen when you select the Brush Trimming tool.

	Brush Size	Set a brush size. The brush comes in three different sizes. 
	Manual Noise Trimming	Remove unnecessary noise data in the area selected with a brush.
	Auto Noise Trimming	Remove unnecessary noise data automatically according to the viewing direction.

- ① Click the "Brush Trimming" from the Trimming tool on the main toolbar.



- ② Select the brush size at the bottom.

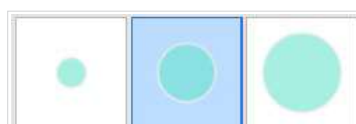

- ③ Select the areas where noise should be trimmed. Only the front face will be selected.



- ④ The selected area is automatically deleted after selecting the area with the mouse.

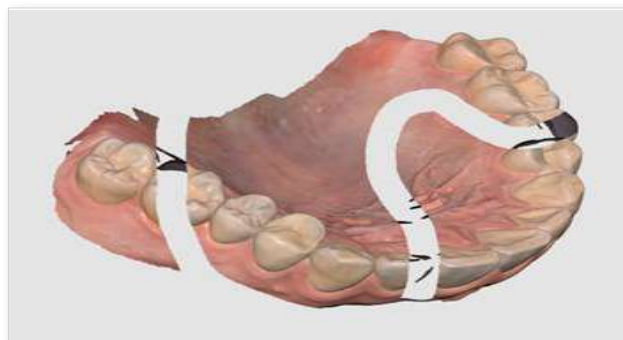

Manual Noise Trimming

You can manually remove the unnecessary noise data.

Note

When this option is off, you can select an area with a brush, but the area is not removed.

- ① Click the "Manual Noise Trimming" tool icon at the bottom.



- ② Select the brush size at the bottom.



- ③ Select the areas where noise should be trimmed.
- ④ The selected area is automatically deleted after selecting the area with the mouse.

Automatic Noise Trimming

You can automatically trim unnecessary soft tissues such as lips, cheeks, and tongue.

- ① Click the "Automatic Noise Trimming" tool icon at the bottom.



- ② The program automatically removes unnecessary soft tissues.

Quick Trimming

- ① Click the "Quick Trimming" from the Trimming tool on the main toolbar.

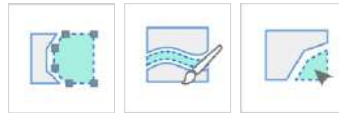



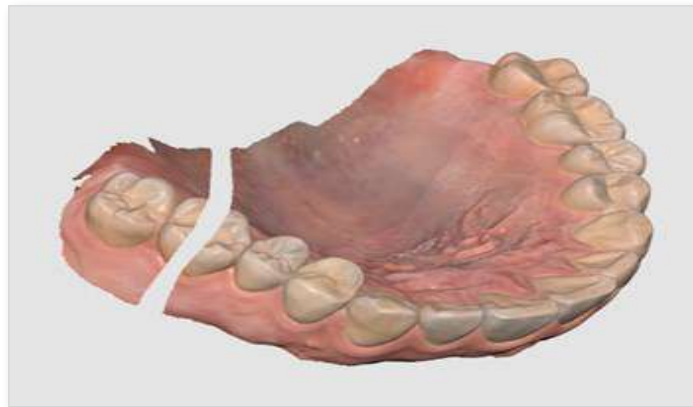



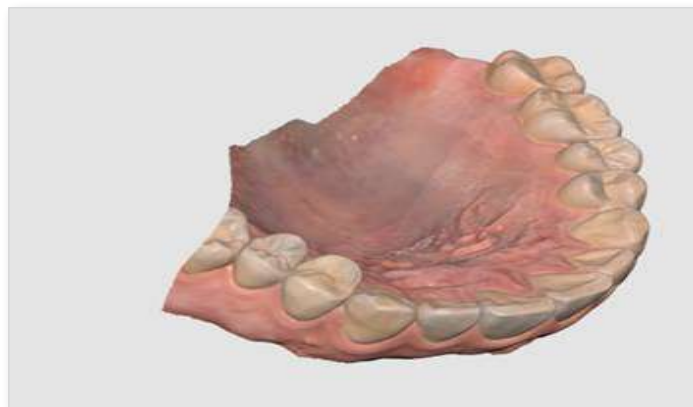

- ② Click on data separated from the rest of the scan data.



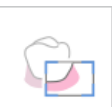

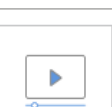

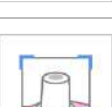



- ③ The isolated area where you clicked is removed as below.

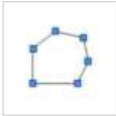

Function Tools

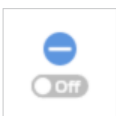
	Lock Area	Lock a specific area using the selection tools.
	Undercut Analysis	Analyze the undercut area based on the direction of insertion.
	Swap Maxilla and Mandible	Swaps maxilla and mandible scans. This is useful if the operator accidentally scans the wrong jaw.
	Result Preview	Show the preview of the selected area to check the quality of data before actual processing.
	Margin Line	Creates a margin line automatically or manually. The margin line information can also be imported into a design program.
	Smart Data Cleaning	Filter out soft tissue data by removing unreliable data using the Reliability Map.
	Scan Replay	Replay the scanning process.
	HD Camera	Take 2D images with 3D model data and share the images with a laboratory.
	Register Abutments	Register an abutment in the library by scanning it yourself or importing it. Once registered, you can use it for Abutment Library Matching.
	Smart Shade Guide	Provide smart shade recommendations.

If you select one of the above function tools on the Main Toolbar, the following selection tools are shown at the bottom to work on the function.

	<p>Polyline Selection</p>	<p>Select all entities within a polyline shape drawn on the screen.</p>
	<p>Circle Selection</p>	<p>Select all entities within a circular area.</p>
	<p>Brush Selection</p>	<p>Select all entities on a freehand-drawn path on the screen. The brush comes in three different sizes.</p>
	<p>Smart Single Tooth Selection</p>	<p>Automatically select the area of a single tooth with a click. You can click or drag on the tooth. * This tool is useful for Lock Area, Margin Line, Preparation Review, and Smart Scan Review.</p>
	<p>Selection</p>	<p>Enable the selection mode to select areas using the selection tools above.</p>
	<p>Deselection</p>	<p>Enable the deselection mode to unselect areas using the selection tools above.</p>
	<p>Clear All Selection</p>	<p>Clear the entire selection.</p>
	<p>Confirm</p>	<p>Apply the results for the selected tool.</p>

Lock Area

You can lock a specific area using the selection tools so that further scanning cannot affect the shapes of the locked area but the color.

Note

This feature is useful when preserving the retracted gingiva data scanned after cord removal.

- ① Click "Lock Area" from the Main Toolbar.



- ② Select an area to lock with area selection tools.



- ③ Select the area you want to lock. The selected area is presented in a different color.



You can unlock the locked area by doing one of the following:

- ① Click the "Deselection" tool icon to switch to the deselection mode, select a selection tool, and mask the areas to unlock.

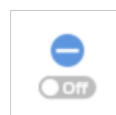

- ② Click the "Clear All Selection" tool icon to unlock all locked areas.



Undercut Analysis

Analyze the undercut area based on the direction of insertion. The insertion direction can be determined by Auto Direction or Manual Direction.

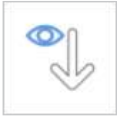
	Auto Direction	The system automatically calculates the direction in which the undercut area is minimized. Then, it displays the undercut area on the View Screen.
	Manual Direction	The system calculates the undercut area based on the view direction of the user. The user can change the view direction by moving or rotating the data. Then, it displays the undercut area on the View Screen.

Undercut Analysis with Auto Direction

- ① Click the "Undercut Analysis" tool icon from the Main Toolbar.



- ② Select the region of interest to calculate the undercut area with area selection tools.



- ③ If no area is selected, the program will calculate the undercut area for the entire 3D model in the data display area.
- ④ Click the "Auto Direction" icon at the bottom.



- ⑤ An insertion path arrow appears in the direction where the undercut area is minimized, and the undercut areas are presented in dark blue.

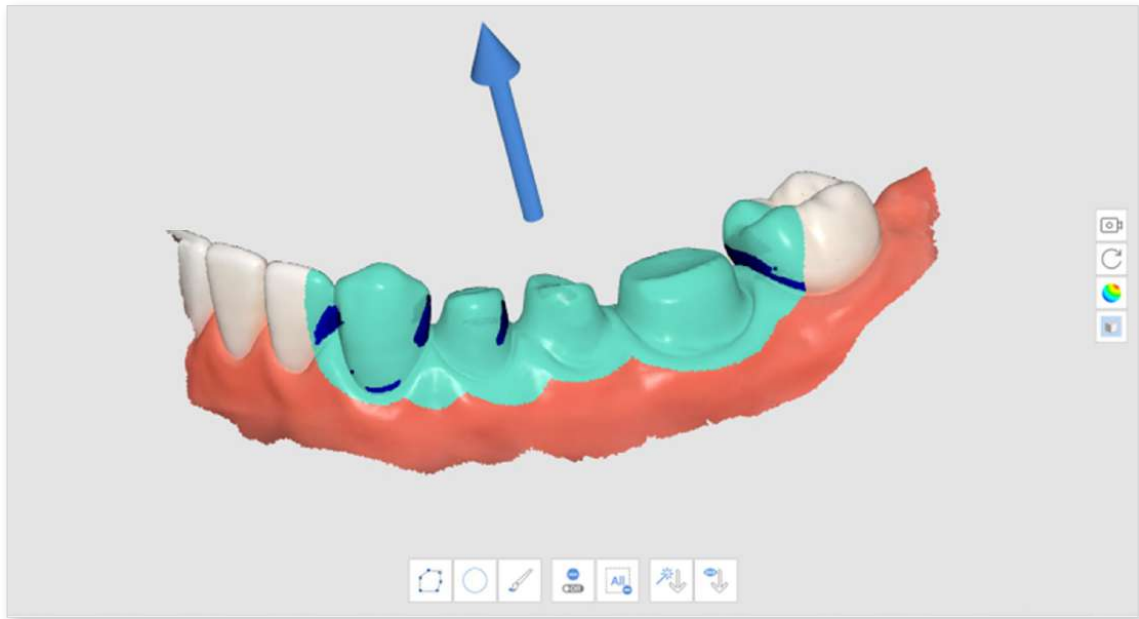

- ⑥ You can change the direction of the insertion path by left-clicking and dragging the arrow.

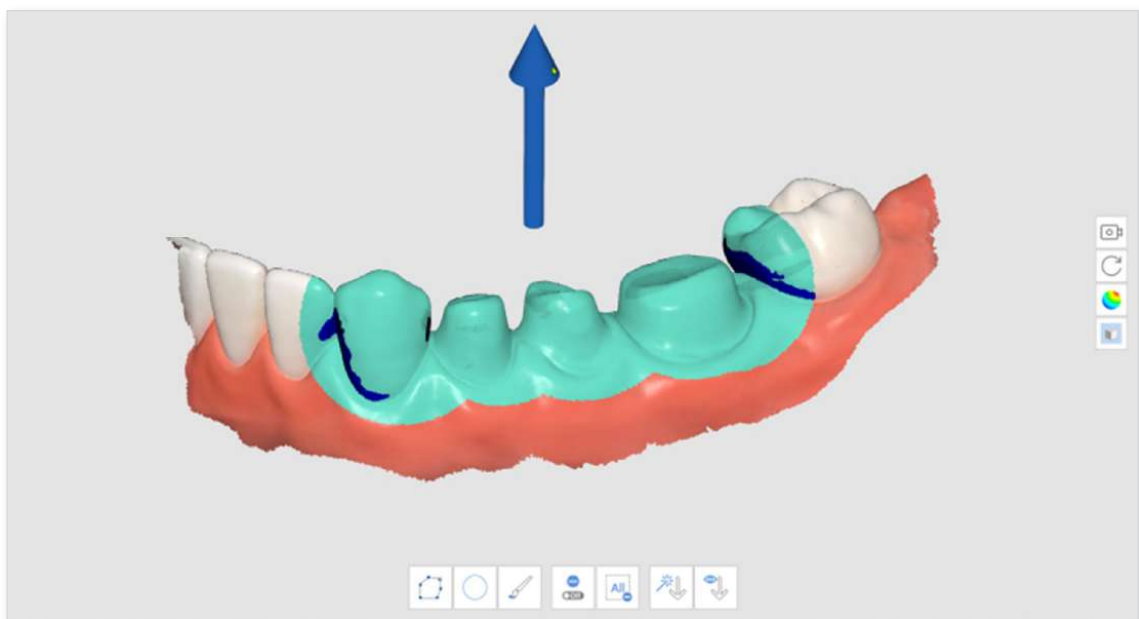

Undercut Analysis with Manual Direction

- ① Click the "Undercut Analysis" tool icon from the Main Toolbar.

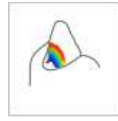

- ② Select the region of interest to calculate the undercut area with area selection tools.
- ③ Use the "Move," "Rotate," "Zoom In," and "Zoom Out" tools on the Side Toolbar to change the model's direction.
- ④ Click the "Manual Direction" icon at the bottom.



- ⑤ An insertion path arrow appears in the direction of the user's viewpoint.
- ⑥ You can change the direction of the insertion path by left-clicking and dragging the arrow.

Swap Maxilla and Mandible

When the mandible is scanned in the maxilla scan stage by mistake or vice versa, you can correct it using this feature.

- ① Click the "Swap Maxilla and Mandible" tool icon from the Main Toolbar.



- ② The current data at the Maxilla and Mandible stages are swapped.

Result Preview

- ① Click the "Result Preview" tool icon from the Main Toolbar.



- ② Select an area to preview with area selection tools.



- ③ Click "Next Step" to view the result.



- ④ Preview the result.

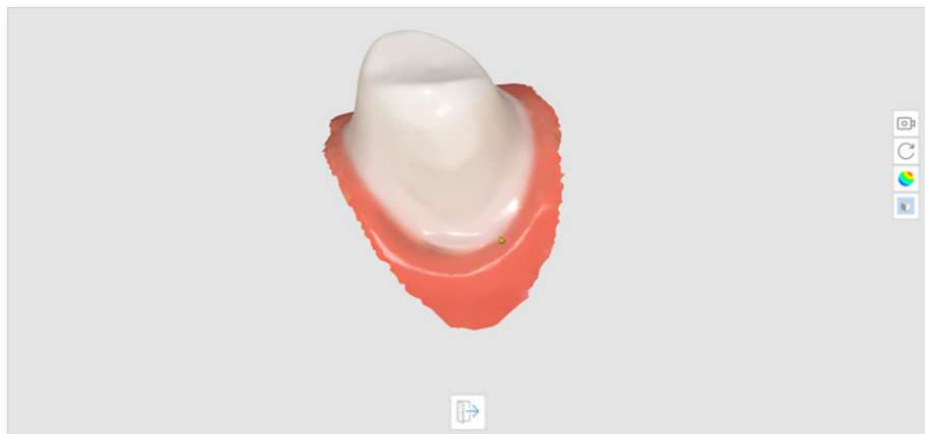









- ⑤ Click "Exit" to go back to the previous step.

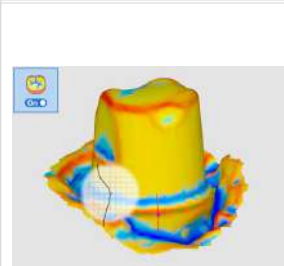
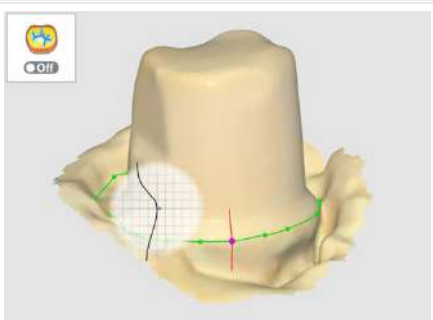

Margin Line

The following tools are provided for the Margin Line feature.

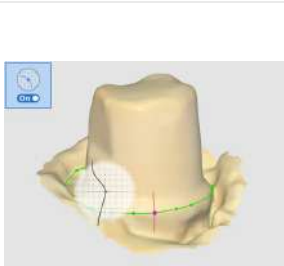
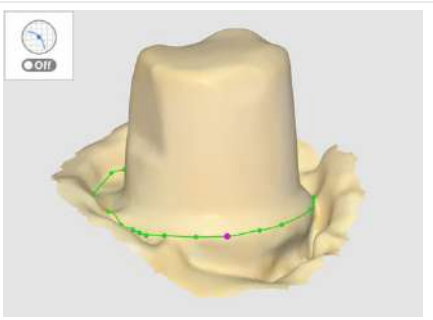
	<p>Auto Creation</p>	<p>Create a margin line automatically based on the points selected by the user. By selecting multiple points, a closed margin line will be created.</p>
	<p>Dynamic View Change</p>	<p>Turn this option on to automatically rotate data according to the view direction.</p>
	<p>Manual Creation</p>	<p>Create a margin line manually according to the points selected by the user. Upon completing a closed curve by manually adding control points, a margin line is created.</p>
	<p>Edit</p>	<p>Enable editing the margin line. The user can add, move, and remove the control points of a margin line.</p>
	<p>Delete</p>	<p>Delete the margin line.</p>
	<p>Curvature Display Mode</p>	<p>Measure the surface curvature of data to display the data in different colors through a color map.</p> <div style="display: flex; justify-content: space-around;">   </div> <p>If the color is redder, it is more embossed, and if the color is bluer, it is more engraved. You can use the color expression interval slider to adjust the color radius.</p>
	<p>Section View</p>	<p>Show the cross-section of the area where the mouse pointer is located</p> <div style="display: flex; justify-content: space-around;">   </div> <p>It prevents any areas from being hidden when zoomed in closely and allows you to check the magnified margin more carefully.</p>

- ① Click the "Margin Line" tool icon from the Main Toolbar.



- ② Select the Maxilla or Mandible stage.
- ③ Select a tooth number.
- ④ Select an area for the selected tooth number with area selection tools, and click the "Next Step" icon.

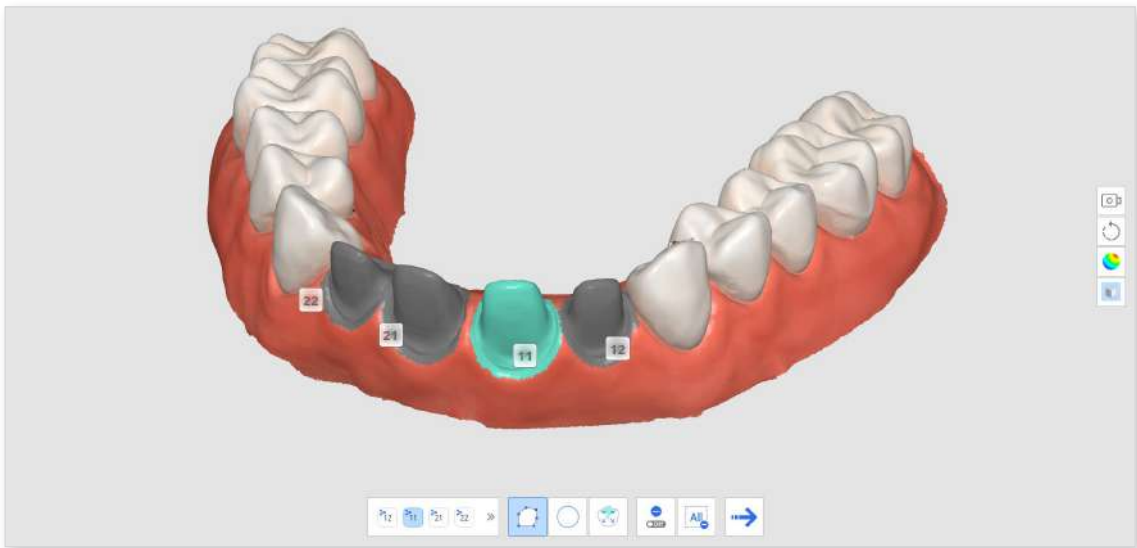

- ⑤ Click the "Next Step" icon.



- ⑥ The system generates a temporary result with the selected area. You can create a margin line using this result data.

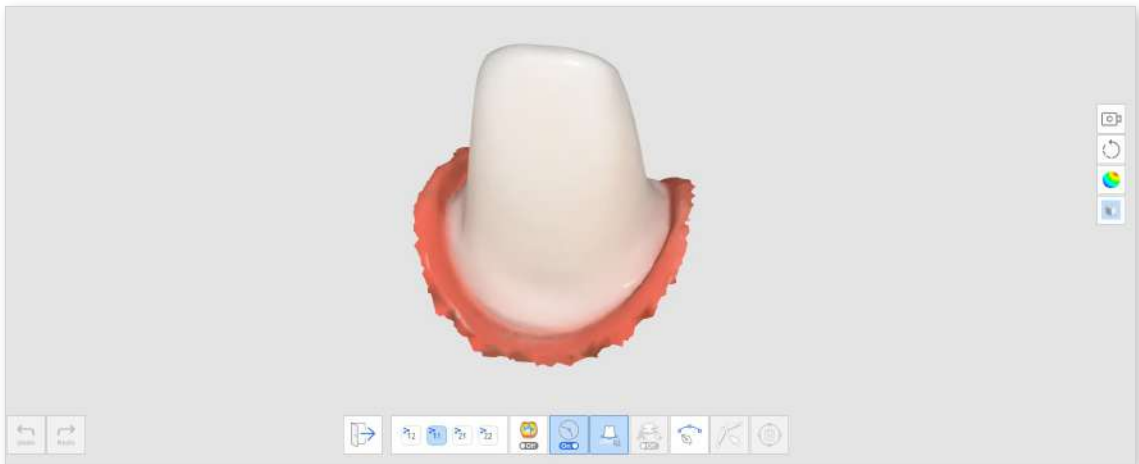

- ⑦ Click the "Auto Creation" or "Manual Creation" icon to draw the margin line.
1. Auto Creation: Click the "Auto Creation" icon and select points. Then, the margin line will be automatically created based on your selected control points.
 2. Manual Creation: Click the "Manual Creation" icon and mark points along the margin line using the left mouse button to link each point to the next. Hold and move the mouse to fine-tune the position of the point on the Section View.

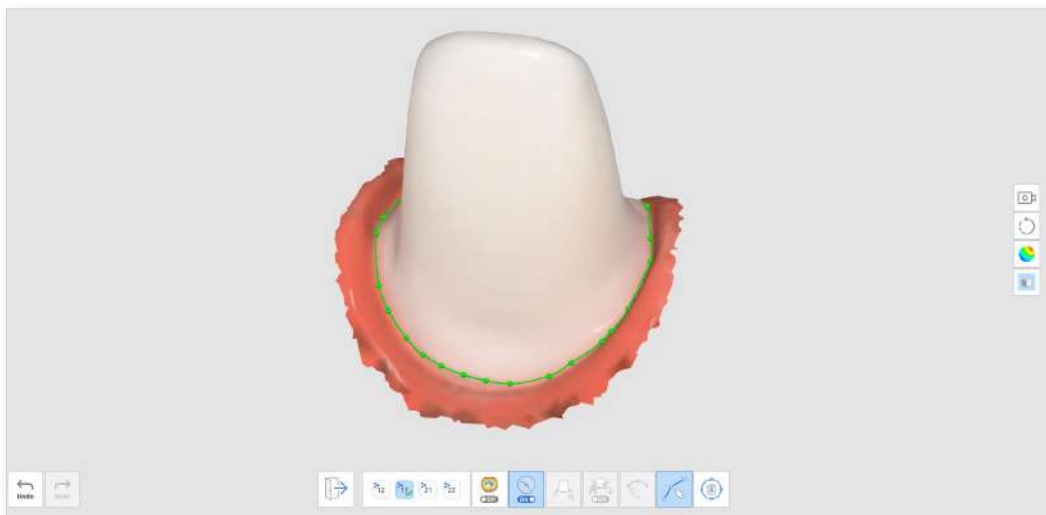

- ⑧ You can make adjustments by clicking the "Edit" icon.
- Add a control point: left-click on the margin line
 - Remove a control point: right-click on a control point
 - Move a control point on the 3D model: left-click on a control point and drag
 - Move a control point on the section: left-click and hold for 1 section a control point and then drag

- ⑨ Click "Exit" to show the margin line with the tooth number.

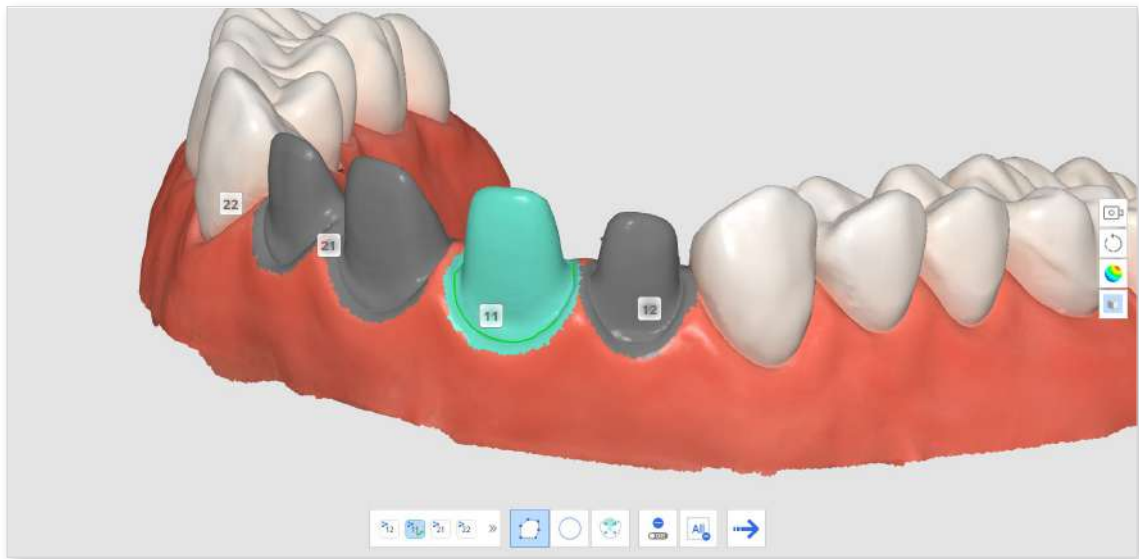



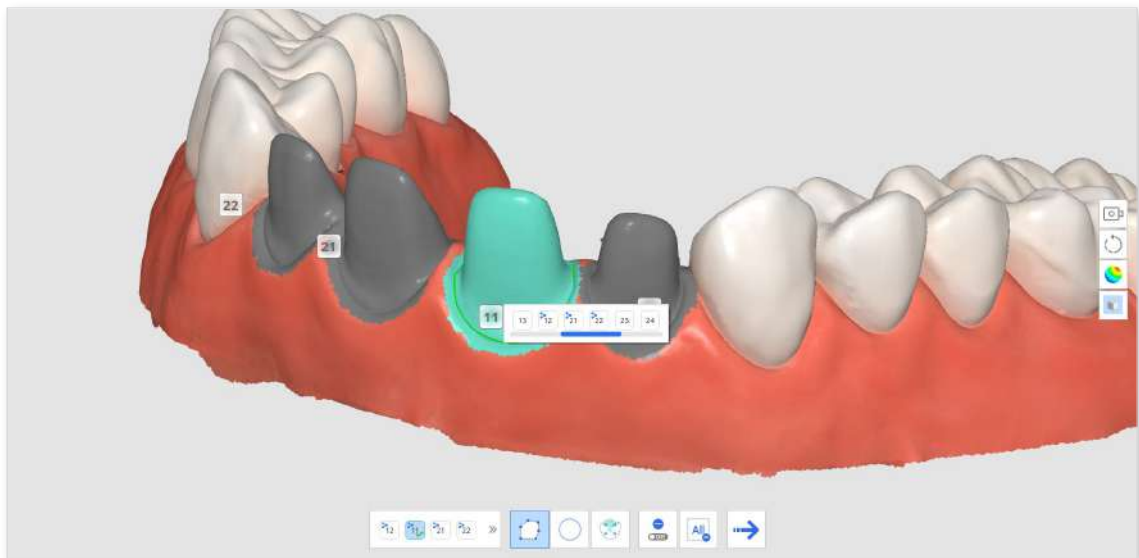



- ⑩ You can change the tooth number for a margin line by clicking a tooth number on the 3D model view and selecting a target number from the pop-up window.

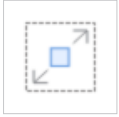

- ⑪ Repeat steps 3-9 to draw margin lines for other teeth.

Smart Data Cleaning

The following tools are provided for the Smart Data Cleaning feature.

	<p>Make Area Edit-Proof</p>	<p>Enable the user to select the area they want to protect from editing.</p> <ul style="list-style-type: none"> • When on, the selected areas are protected from deletion. • When off, the selected areas are the target for deletion.
	<p>Select Teeth Area</p>	<p>Select only the teeth area in the scan data.</p> <p>* This option is only enabled when the Make Area Edit-Proof option is turned on.</p>
	<p>Strength</p>	<p>Select the data with a slider bar. You can select and remove the soft tissue using the reliability map.</p> <ul style="list-style-type: none"> • Increasing the strength expands selected areas. • Adjusting the slider bar changes the selected areas in real-time.
	<p>Flood Fill Selection</p>	<p>Select all data in the connected area.</p>
	<p>Shrink Selected Area</p>	<p>Reduce the selected area each time the user presses the button.</p>
	<p>Expand Selected Area</p>	<p>Expand the selected area each time the user presses the button.</p>
	<p>Invert Selected Area</p>	<p>Invert the selection of area. The selected area will be deselected, and the previously not selected area will get selected.</p>
	<p>Delete Selected Area</p>	<p>Delete the data in the selected area.</p>

- ① Click the "Smart Data Cleaning" tool icon from the Main Toolbar.



- ② Adjust the "Strength" slider bar to select the amount of unreliable data to delete. The system selects data based on the reliability map and shows it in real time as you adjust the slider bar.

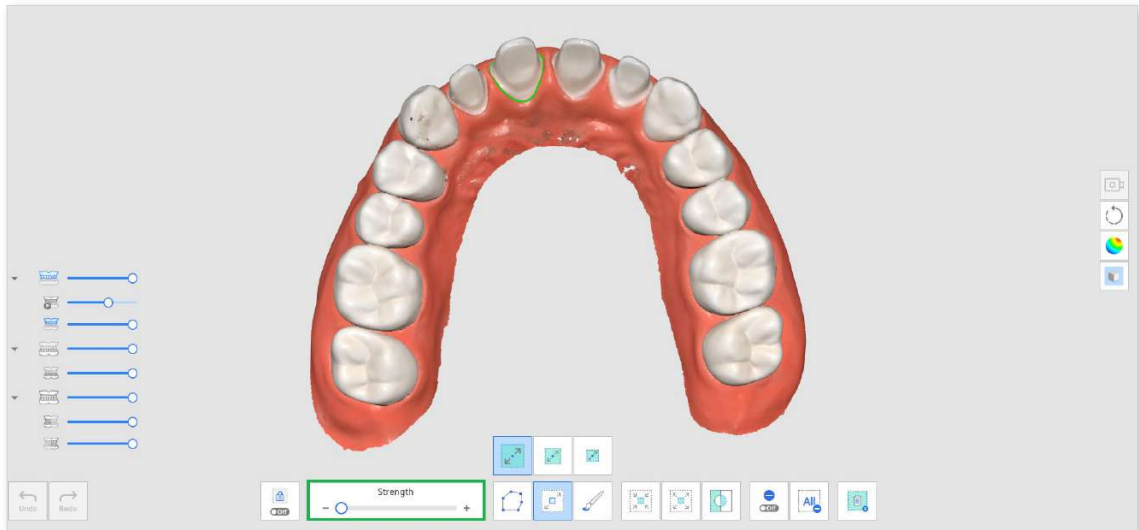

- ③ Increasing the strength will expand selected areas.

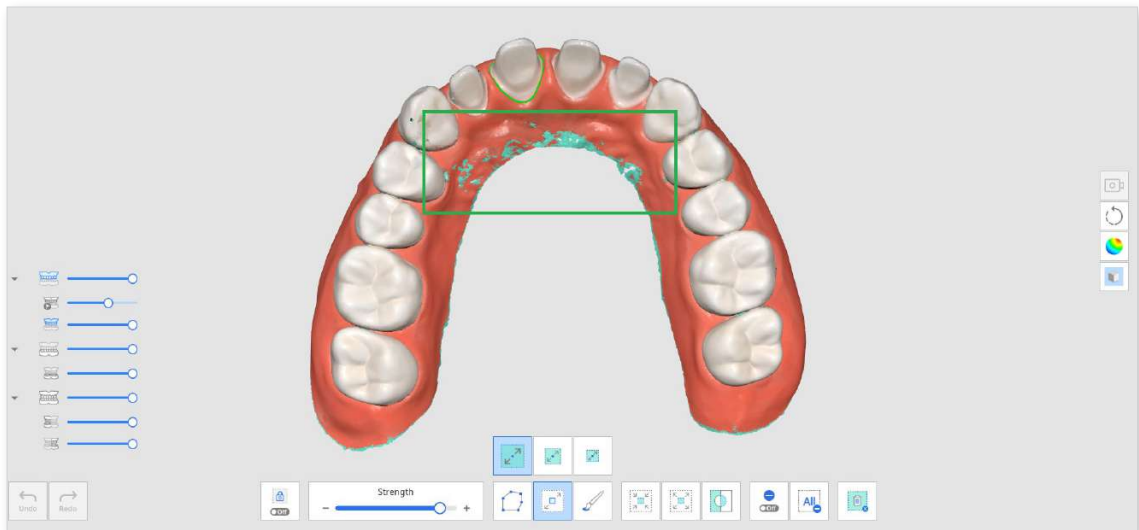

- ④ Select areas you want to delete with various selection tools.

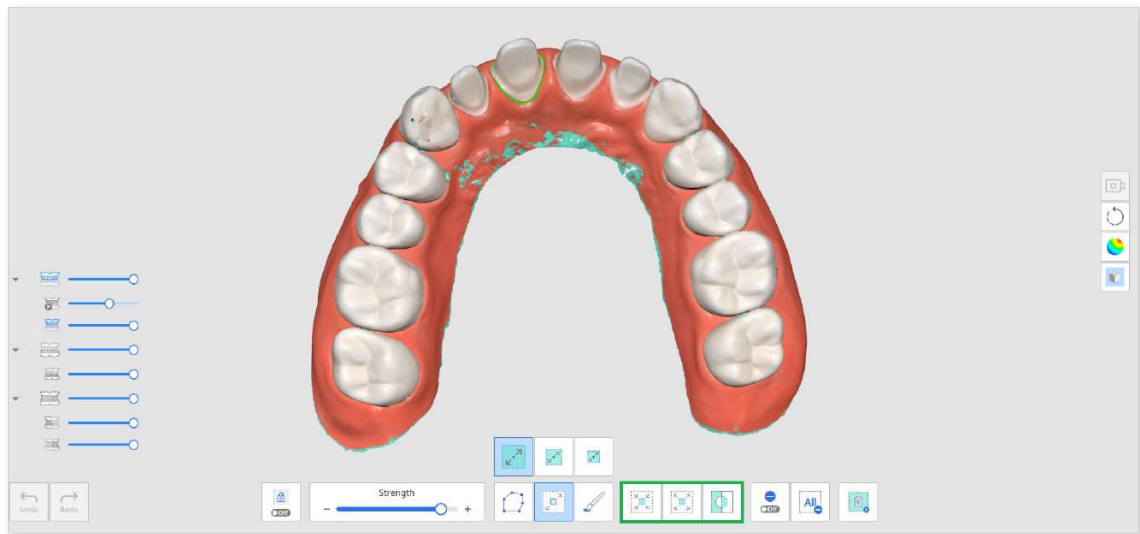



- ⑤ Click the "Delete Selected Area" icon to delete all selected areas.



Scan Replay

You can replay your scanning process after scanning data in Medit Scan for Clinics. This feature is helpful for checking the scanning environment and habits of the user.

The following tools are provided for the Scan Replay feature.

	Scanner Tip	Show or hide the scanner tip during replay.
	Scan Area	Show or hide the scanning area during replay.
	Reverse Tip Direction	Change the direction of the tip during replay. * Unavailable with i500, i900

- ① Click the "Scan Replay" tool icon from the Main Toolbar.



- ② Select the scan replay options in the lower left corner of the screen. The scanner tip and scanning area will be shown in the video, depending on your selection.

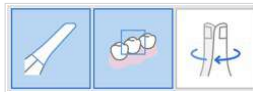



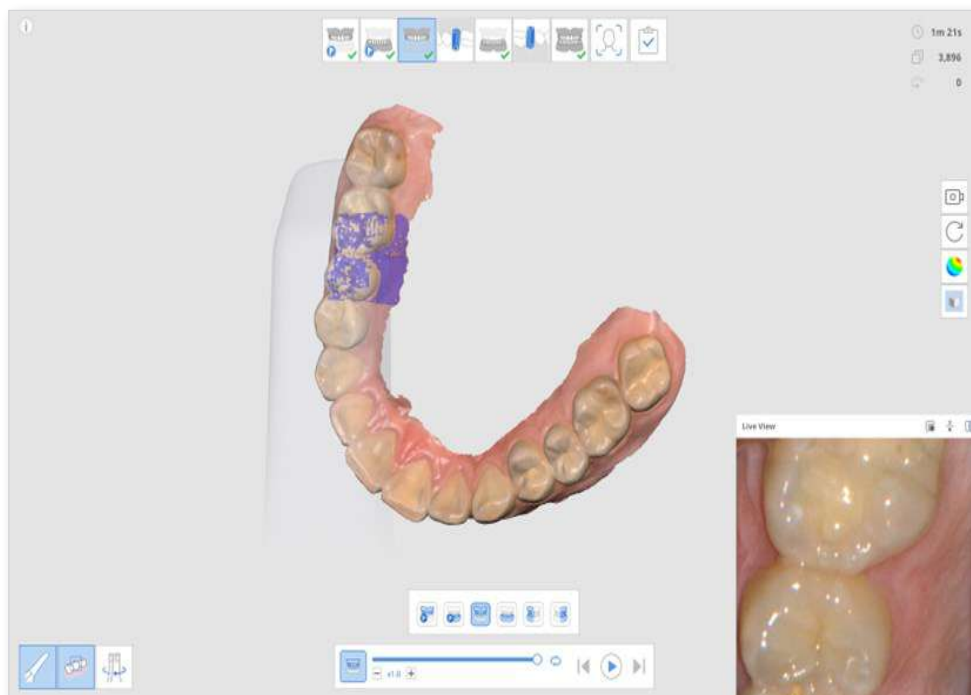



- ③ Click the "Play" button to start the replay.



- ④ The selected stages will be replayed in sequence.

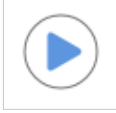

- ⑤ You can use various tools provided to control the video.

	Slider Bar	Start the video from the point of interest.
	Video Speed	Change the speed (x0.5, x1.0, or x3.0).
	Repeat	Play on repeat.
	Previous Replay	Replay the scan of the previous stage.
	Play	Start playing the scan replay.
	Stop	Stop the scan replay.
	Next Replay	Replay the scan of the next stage.

HD Camera

- ① The HD camera feature takes high-quality images using the scanner.
- ② Select the "HD Camera" tool icon from the Main Toolbar.





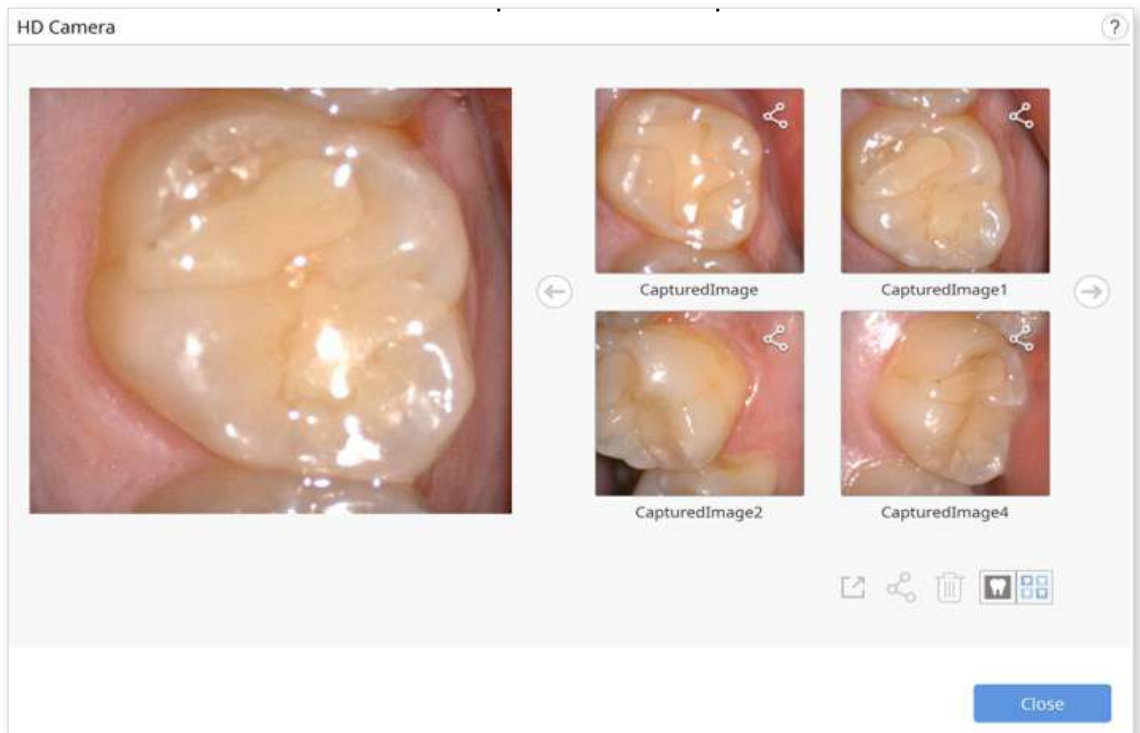

- ③ The HD Camera dialog appears.

- ④ Place the scanner tip on the region of interest.
- ⑤ Press the Scan button on the handpiece to take a picture.



- ⑥ You can rename an image by clicking on the image and entering the new name.
- ⑦ You can share, export, or delete the image using the following tools provided at the bottom of the dialog.

	Export the selected files to the local computer.
	Share the selected image or stop sharing the image.
	Delete the selected image.
	Change the view style of a thumbnail.

- ⑧ The captured images are saved to Medit Link as attachments when you exit Medit Scan for Clinics after saving the changes.

Register Abutments

You had to receive custom abutment files created by table top scanners in labs or even make unnecessary cases in Medit Clinics to scan the abutment and create 3D data, making it difficult to get proper use out of "Abutment Library Matching."

The Register Abutments feature allows you to scan the patient's abutment directly in their case and register it as a library. Before the implanted fixture is placed in the patient's mouth, scan the abutment first and register it as a library. Then, you can use "Abutment Library Matching" to replace the scan data with the library data.

Note

Please refer to [Case and Workflow Examples > Abutment Library Matching](#) on how to use the registered abutments.

The following tools are provided for the Register Abutments feature.

	Add	Add abutments. You can add via scanning or importing.
	Fill Holes for Abutments On/Off	Turn the toggle on and off to fill holes for abutments while merging.
	Merge Abutments	Merge scanned or imported abutments.
	Fill Hole From Your Viewpoint	Fill the abutment's hole from the direction you are looking at.
	Reset Abutment	Reset to undo any changes made to the abutment.
	Register in Library	Register the merged abutment in the library. It will be used only for that specific case if you check the box.

- ① Click the "Register Abutment" tool icon on the Main Toolbar.



- ② You will see the above-described tools at the bottom of the screen.

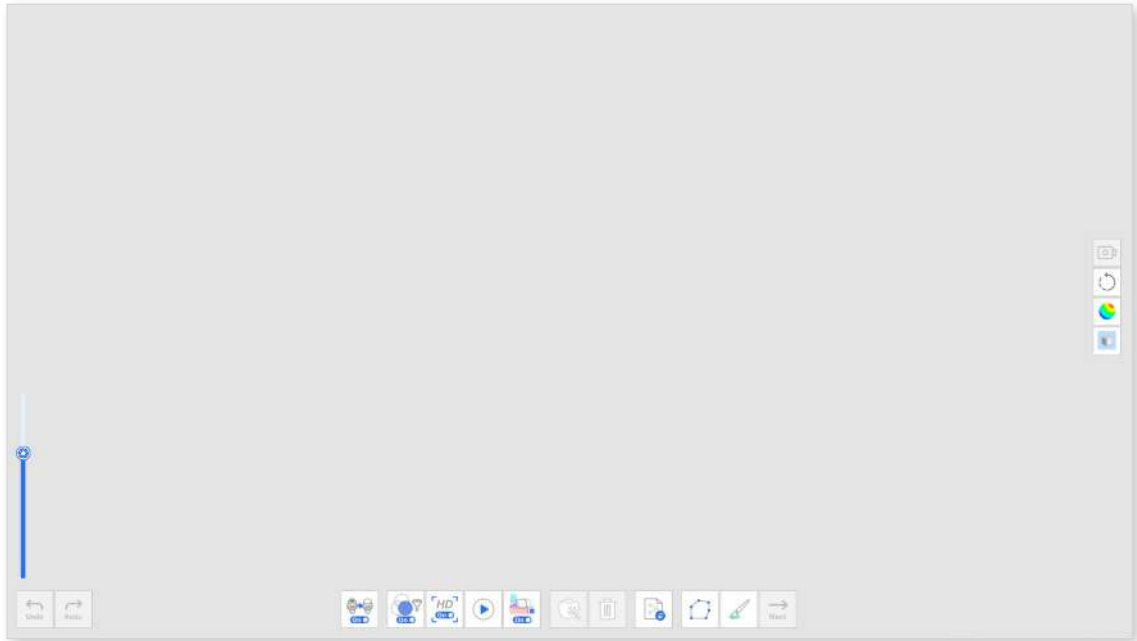

- ③ Scan the abutment.

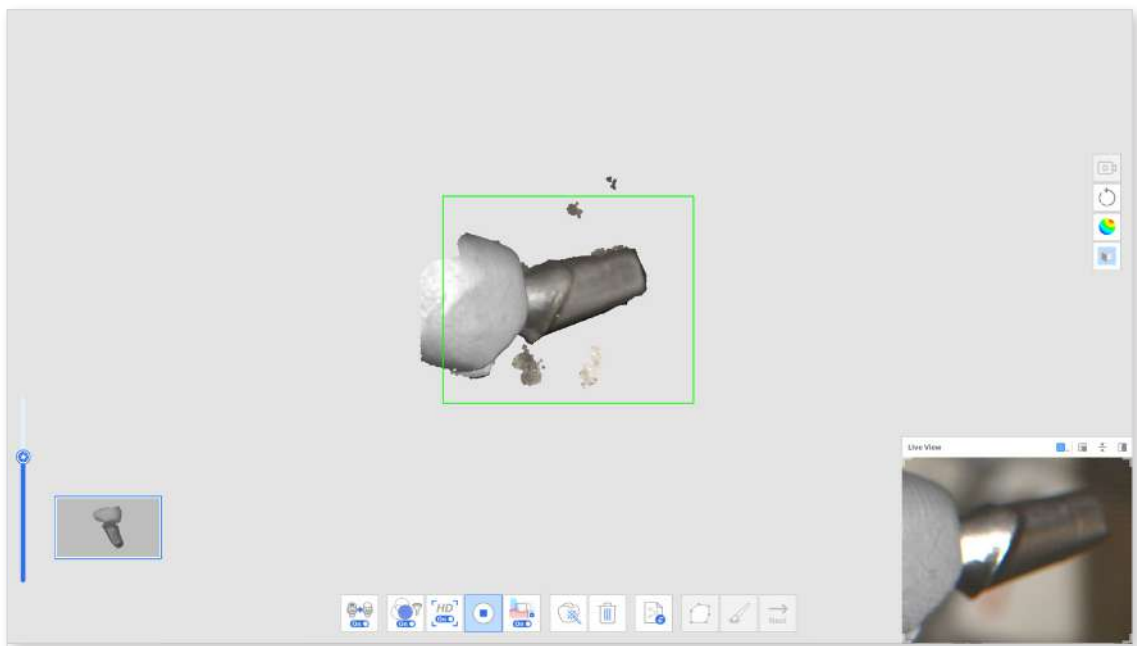

- ④ You can edit the data using the Polyline and Brush Trimming tools when you stop scanning.

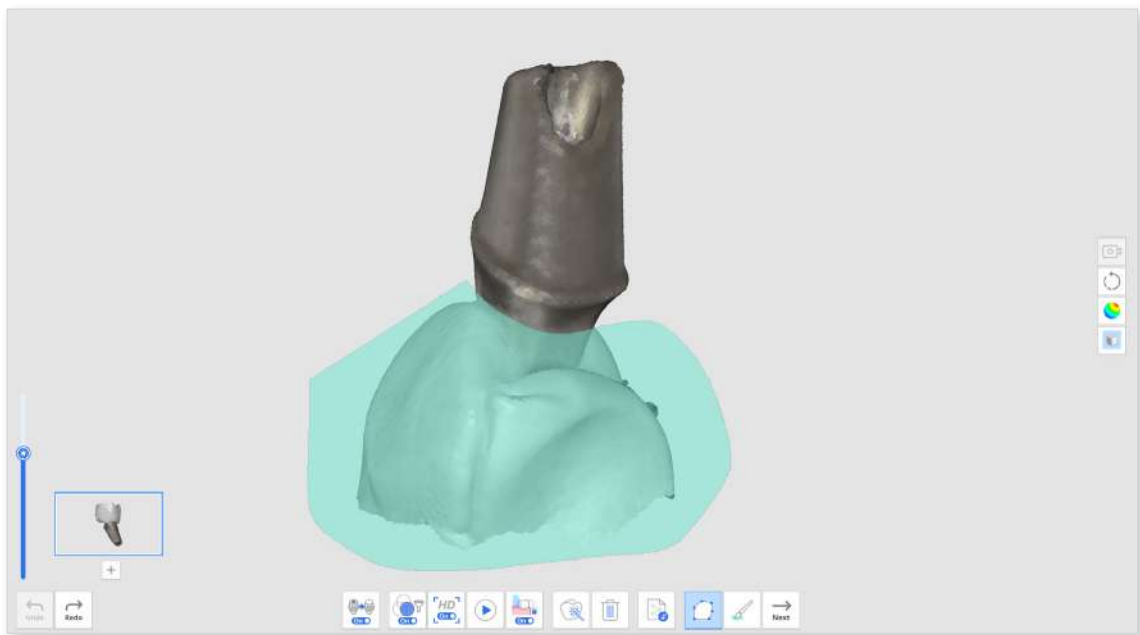
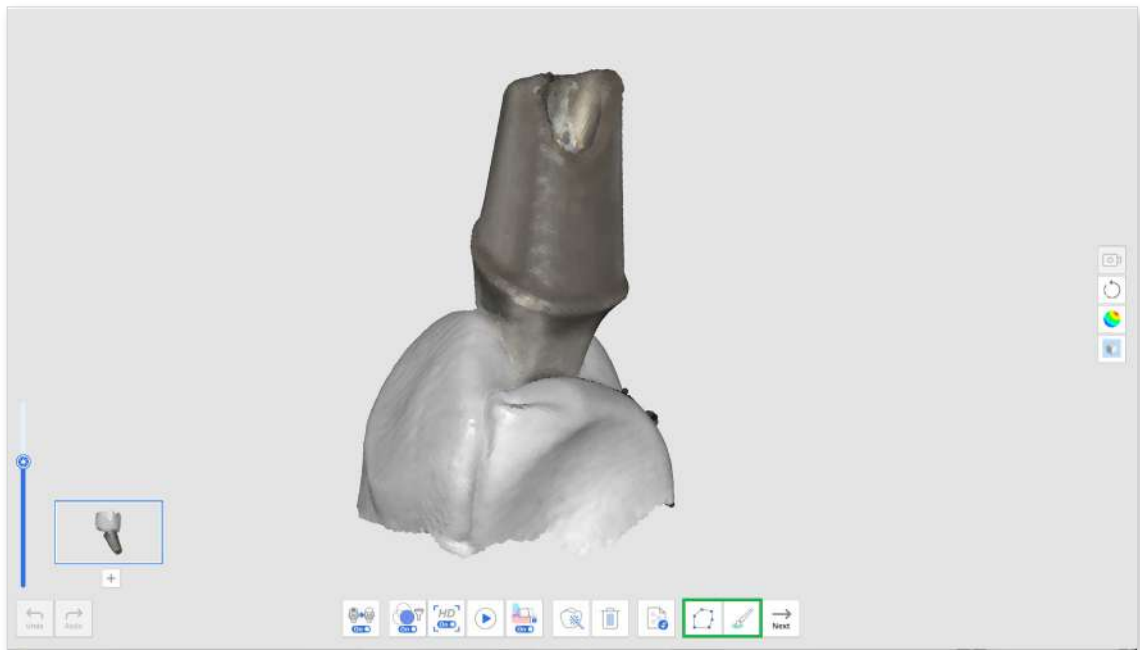

- ⑤ Click the "+" button below the abutment thumbnail to scan another abutment. You can scan and register up to 6 abutments.

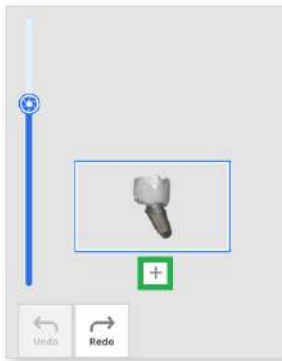

- ⑥ After scanning all the abutments, click the "Merge Abutment" button to merge the abutment data for library registration.

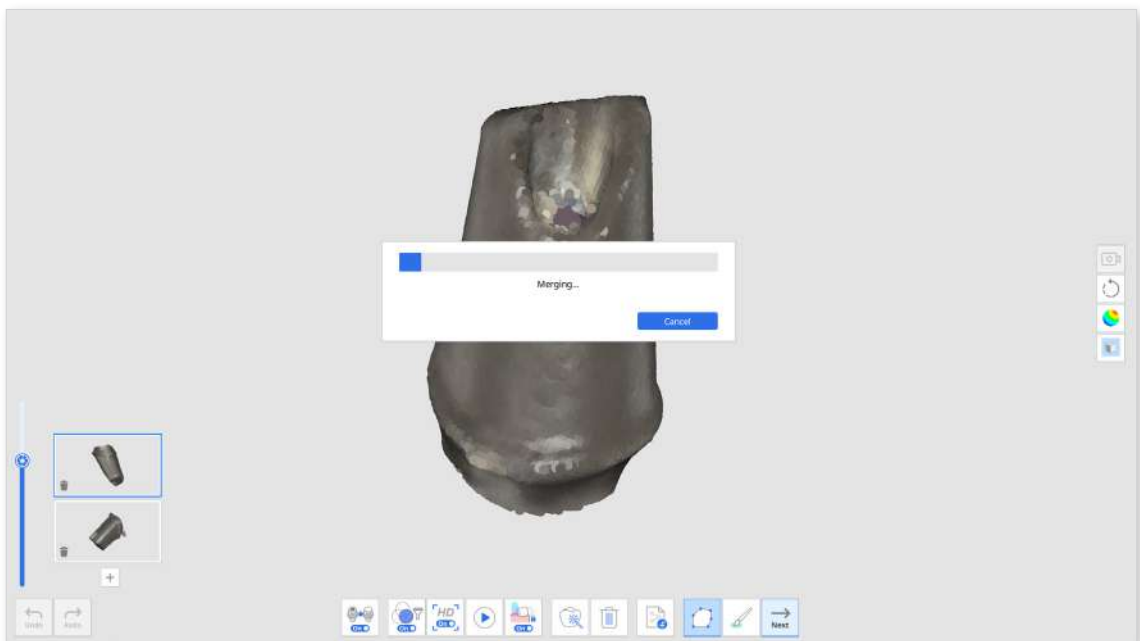

- ⑦ When the merge is complete, the abutment is displayed on the screen. You can remove the auto-filled holes or edit the abutment data with Polyline and Brush Trimming tools if necessary.



- ⑧ Click the "Register Abutment" button when editing is complete.



- ⑨ Enter the name of each merged abutment and click "Confirm."

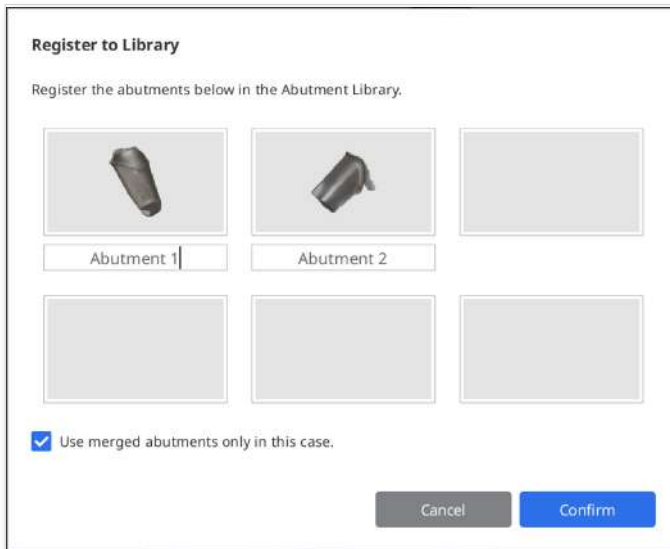

Note

If you want to keep and use the abutment libraries for other cases, uncheck the "Use merged abutments only in this case" check box.

Then, the libraries will be registered in the Collections tab instead of the Single-Use tab on the Abutment Library window so you can save and use them in other cases later if needed.

- ⑩ Check if your abutments are successfully added to the library when the Abutment Library dialog appears.

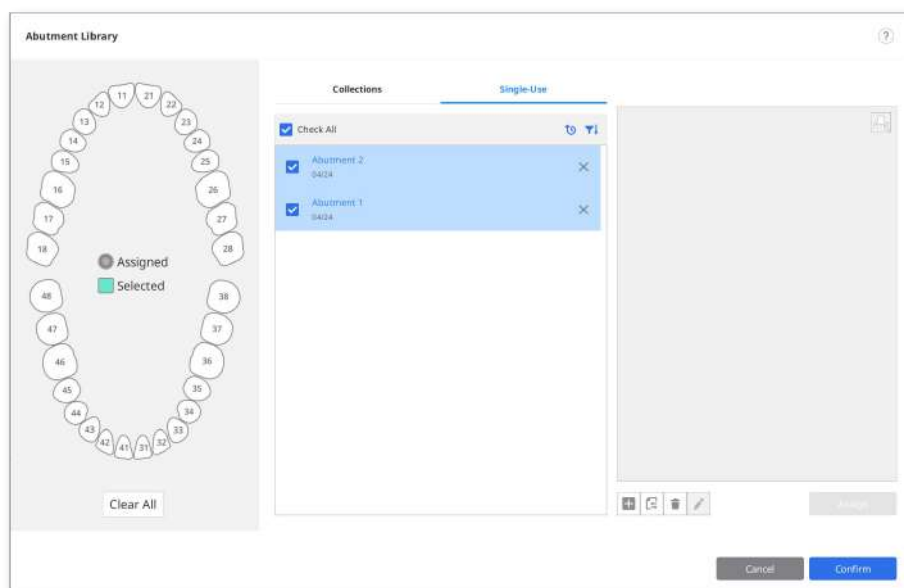

- ⑪ Click "Confirm" to close the dialog.

Smart Shade Guide

Note

This feature is unavailable with data acquired with the i500.

The Smart Shade Guide will recommend the closest shade using data analysis.

We support the following shade guides:

- VITA Classical
- VITA 3D-Master Shade Guide

① After scan data acquisition, click the "Smart Shade Guide" tool icon on the Main Toolbar.



② Click on the scan step icon on the left side of the screen to select the area for which you want to receive measurements.

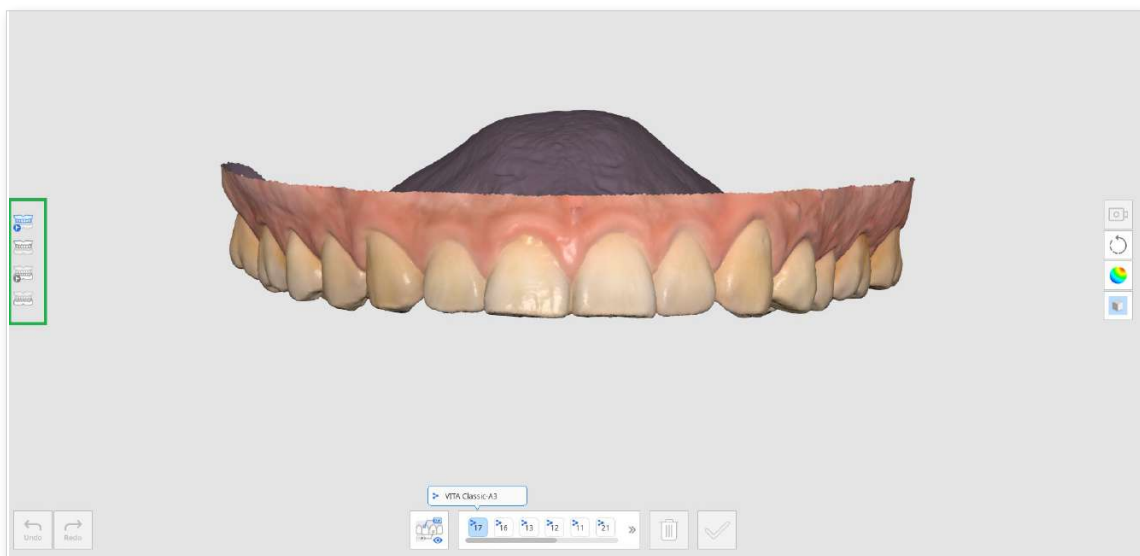

- Pre-Op for Maxilla
- Pre-Op for Mandible
- Maxilla
- Mandible
- Maxilla Denture
- Mandibular Denture

- ③ Select the tooth number from the list of tooth numbers at the bottom. Clicking on the tooth number will display the shade information registered in Medit Link.

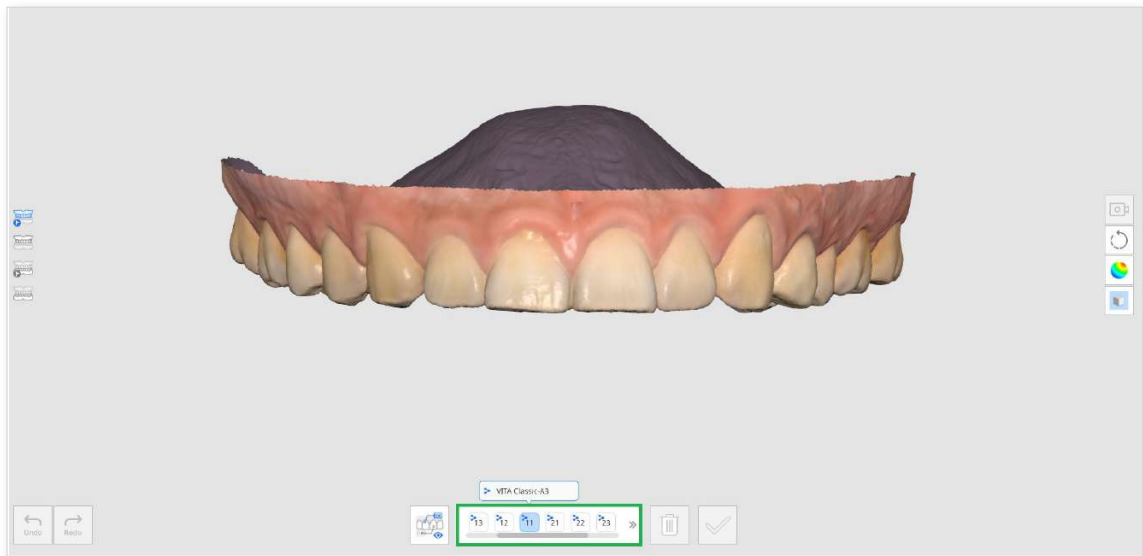

- ④ When you hover the mouse cursor over the scan data for that tooth, the cursor changes its shape for shade recommendations. If you hover over a nonmeasurable area, you will be informed that the measurement is not feasible.

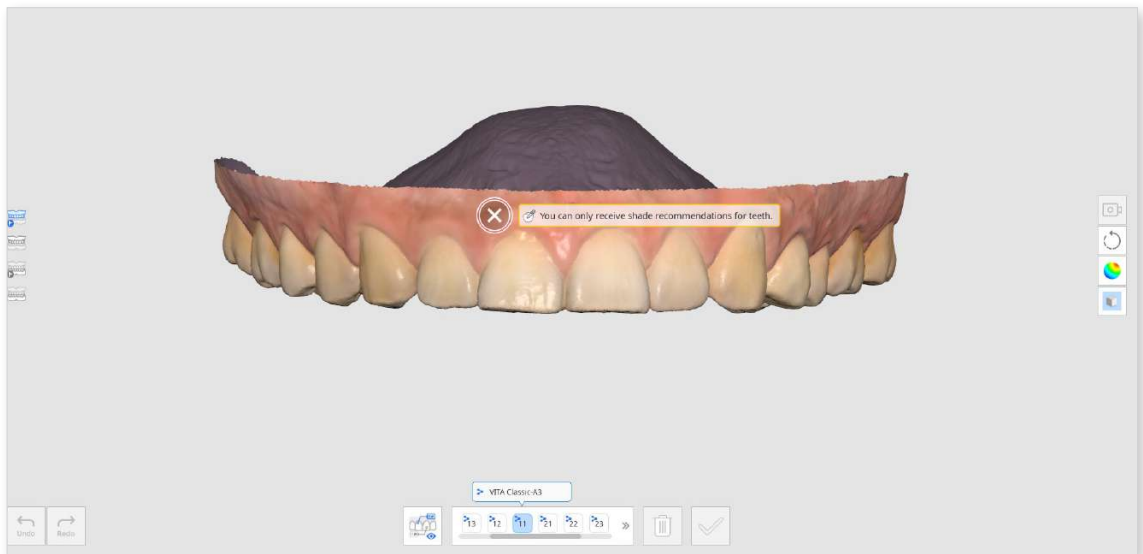

- ⑤ Left-click on the tooth area to see shade recommendations. The star icon indicates the closest matching shade.

- ⑥ If you want to designate a shade other than the recommendation, click "Manual" and select the desired shade from the list.

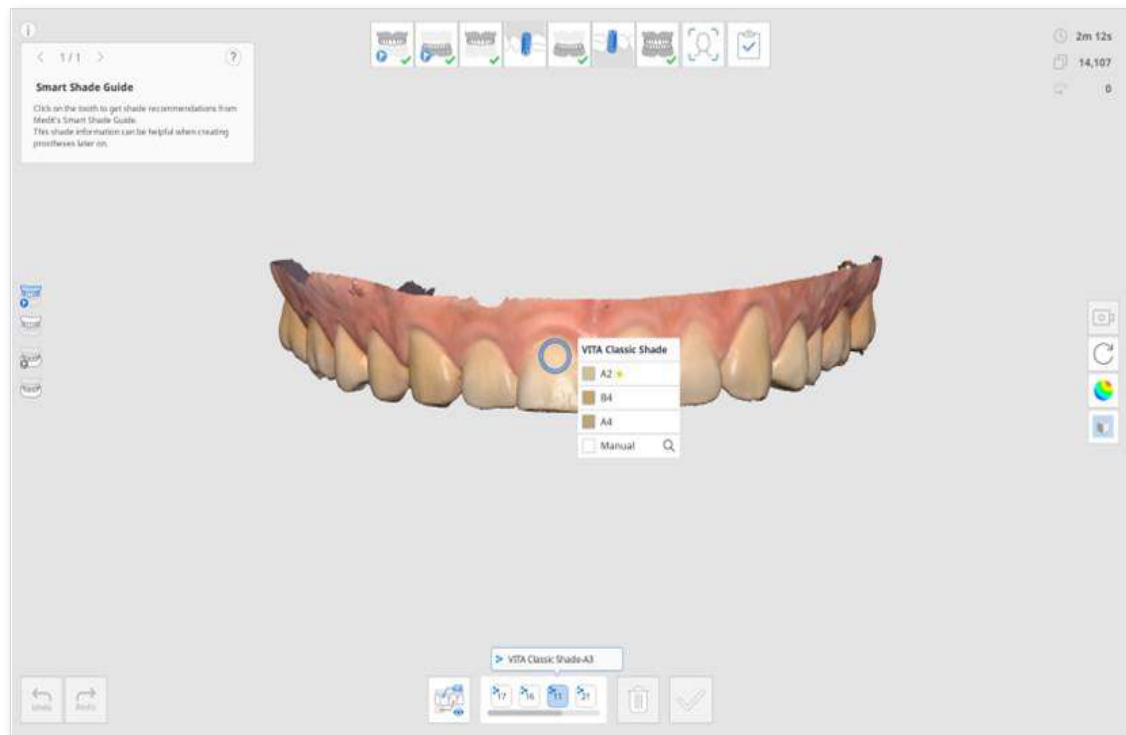

- ⑦ Click the desired shade from the list.

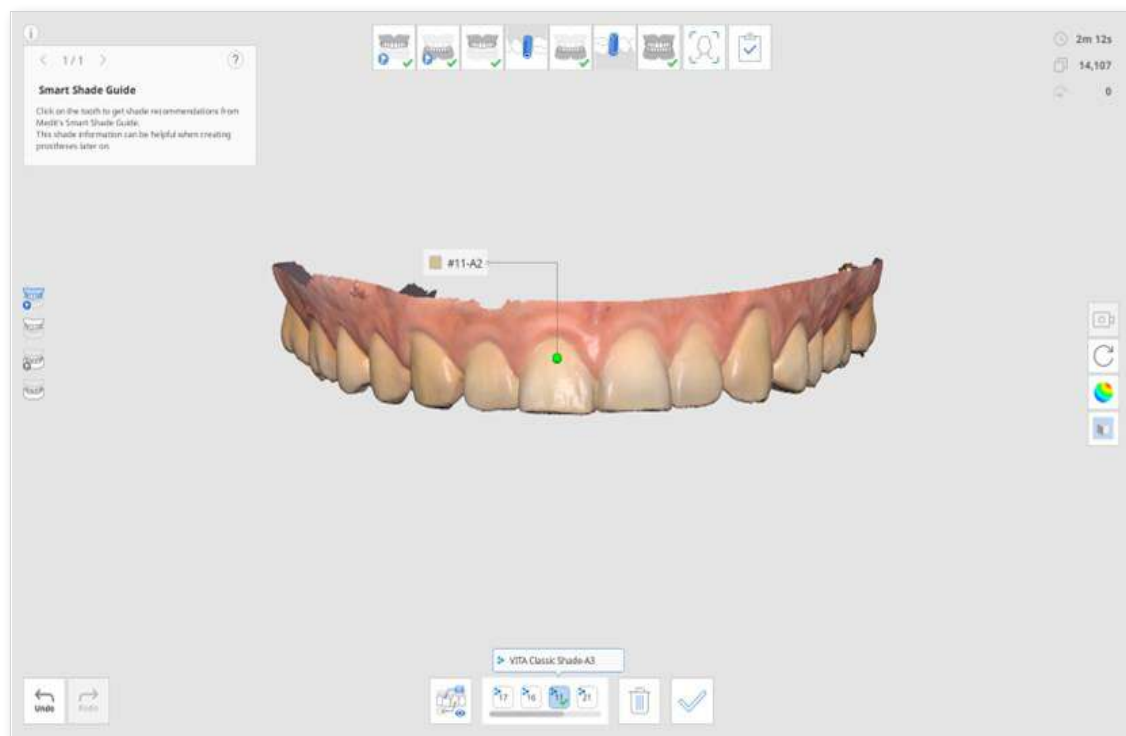

- ⑧ You can save up to five shades per tooth.



- ⑨ After selecting all shades, click "Confirm Shade" at the bottom.
- ⑩ The shades selected for each tooth are shown on the Update Shade Information dialog.
- ⑪ Select the representative shade that will be saved to the Medit Link.

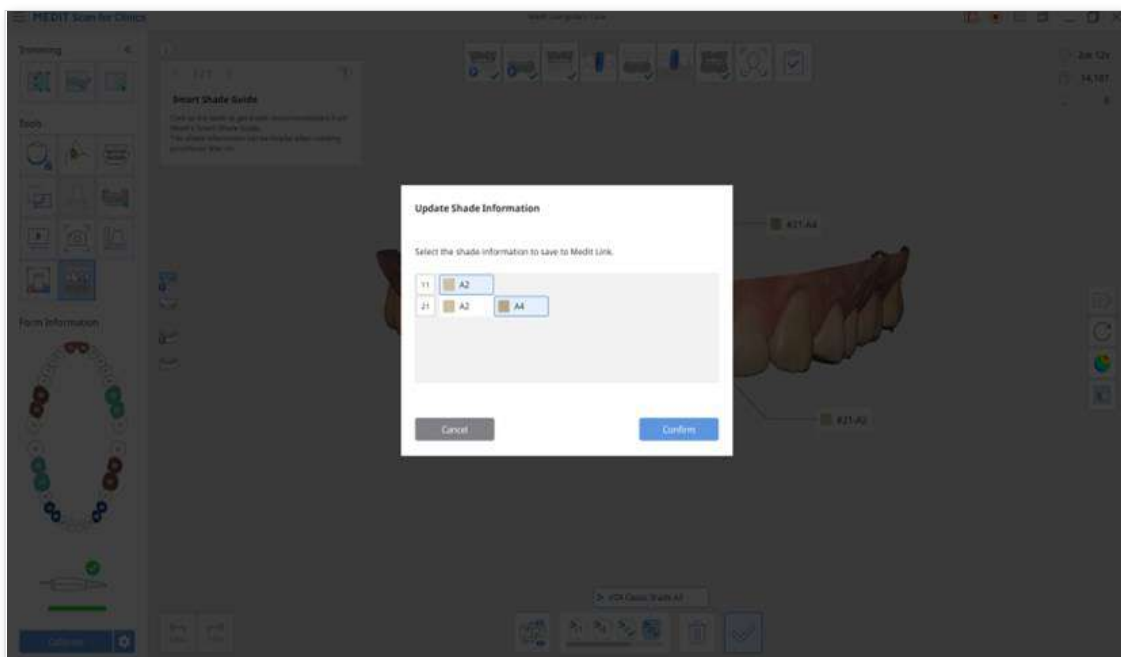

- ⑫ Click "View All" to display all shade information.





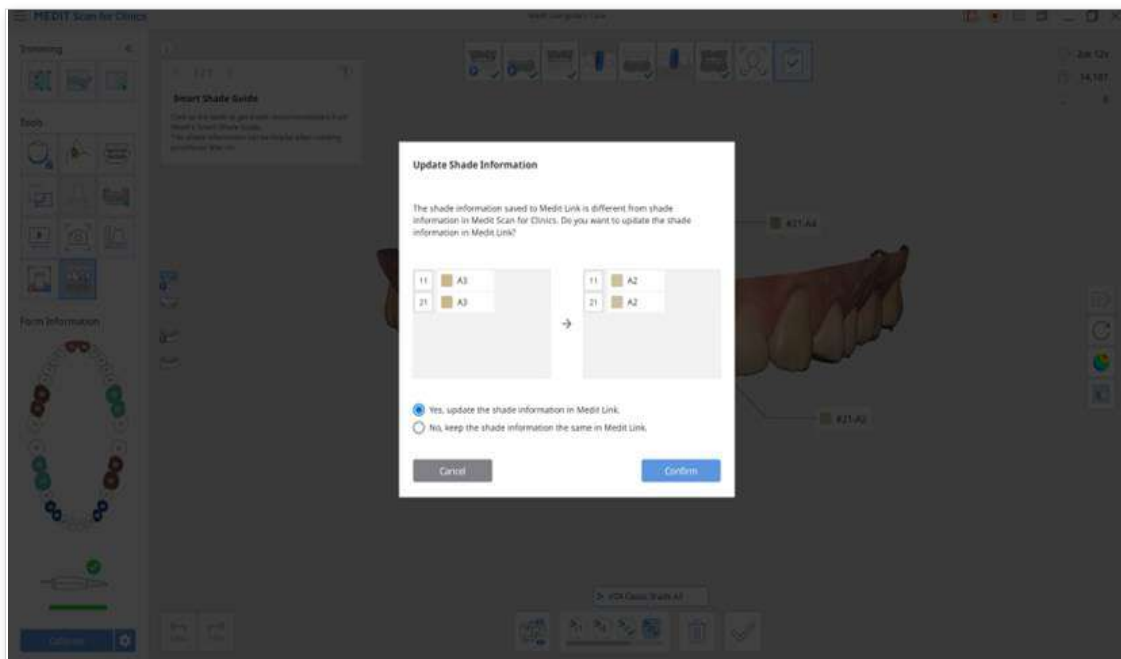





- ⑬ When completed, select how you'd like to update the form information in Medit Link.







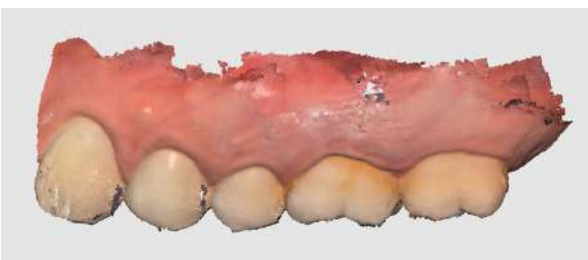

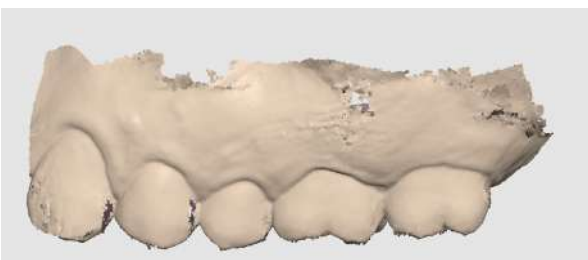
Side Toolbar Tools

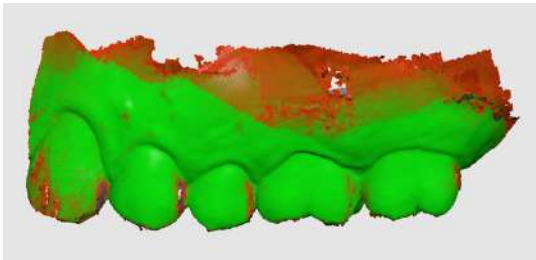
Note

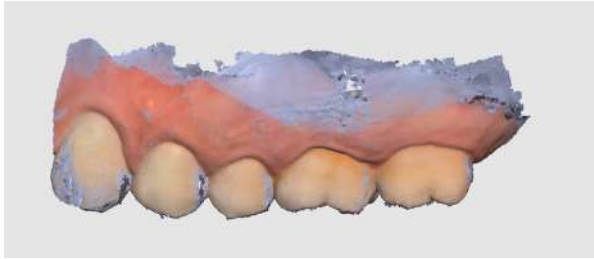
Go to Settings > Program Preferences > Interface and enable the "Expand Model Control Icons" option to show the Pan, Zoom In/Out, and Zoom Fit icons.

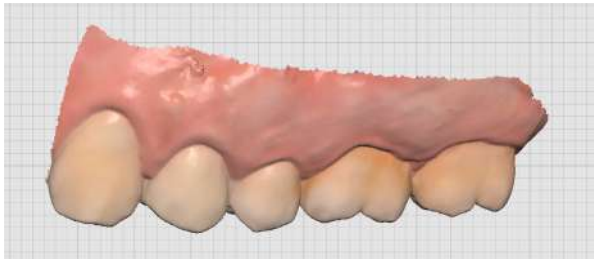
	Camera View Mode	Change the camera view mode between the "Dynamic View" and "Fixed View" modes.
	Pan	Move the model.
	Rotate	Rotate the model.
	Zoom In/Out	Zoom in and out on the model.
	Zoom Fit	Position the model in the center of the screen.
	Model Display Mode	Texture On 
		Texture Off 

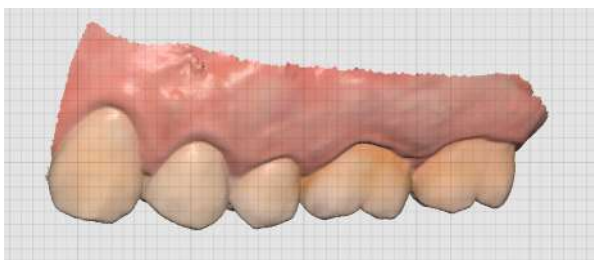
	<p>Model Display Mode</p>	<p>Reliability Map</p>	<p>Apply red, yellow, and green colors to the model to indicate the reliability of scan data.</p> <p>* Green data indicates high reliability, while red indicates poor reliability. You can perform additional scanning to reduce unreliable areas.</p> 
		<p>Texture On + Reliability Map</p>	<p>Assist in acquiring better results by allowing reference to the reliability map while also scanning with the texture on.</p> 
	<p>Settings (mm)</p>	<p>Grid On</p>	<p>Shows the grid in the background.</p> 
		<p>Grid Off</p>	<p>Hide the grid in the background.</p>
		<p>Overlay On</p>	<p>Overlay the grid over the model.</p> 

Case and Workflow Examples

Denture Scan

The denture sequence can be utilized for scanning the patient's current denture, temporary denture, or wax rim.

Note

The Maxillary/Mandibular Denture stage appears when the form is registered as Arch (Full Denture, Denture Replica, or Implant Supported Denture) on Medit Link.

- Ensure all sides of the denture are sufficiently scanned, including labial/buccal and palatal/lingual surfaces.
- For the maxilla, make sure to scan the palatal area, including the palatal rugae and maxillary tuberosity.
- For the mandible, make sure to scan the retromolar triangle.
- If the camera is lost during scanning, start again at the palate's most prominent part, such as palatal rugae or residual alveolar ridge.

Full Denture

The workflow of full denture appears as follows.



Acquire Edentulous Scan Data

Scan the edentulous maxilla/mandible at the Edentulous Maxilla/Mandible scan stage and the denture data at the Maxillary/Mandibular Denture stage.

- ① Scan the edentulous surface for the maxilla.

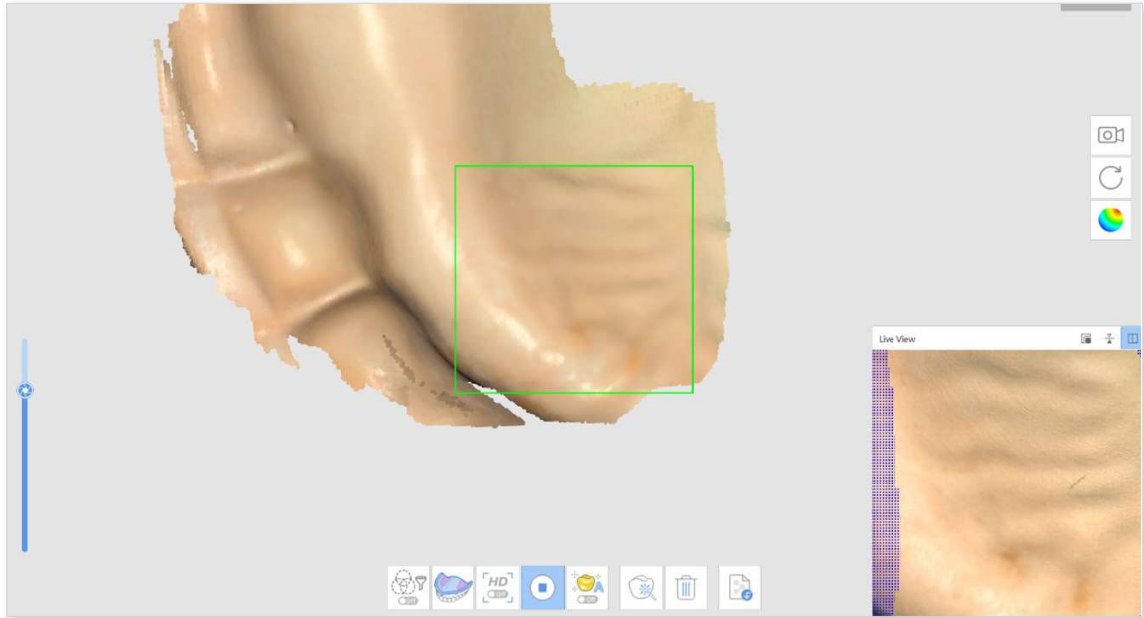

- ② The edentulous data acquired at the first scan stage (Edentulous Maxilla) will be reversed and used as the basis for the denture alignment at the next scan stage.

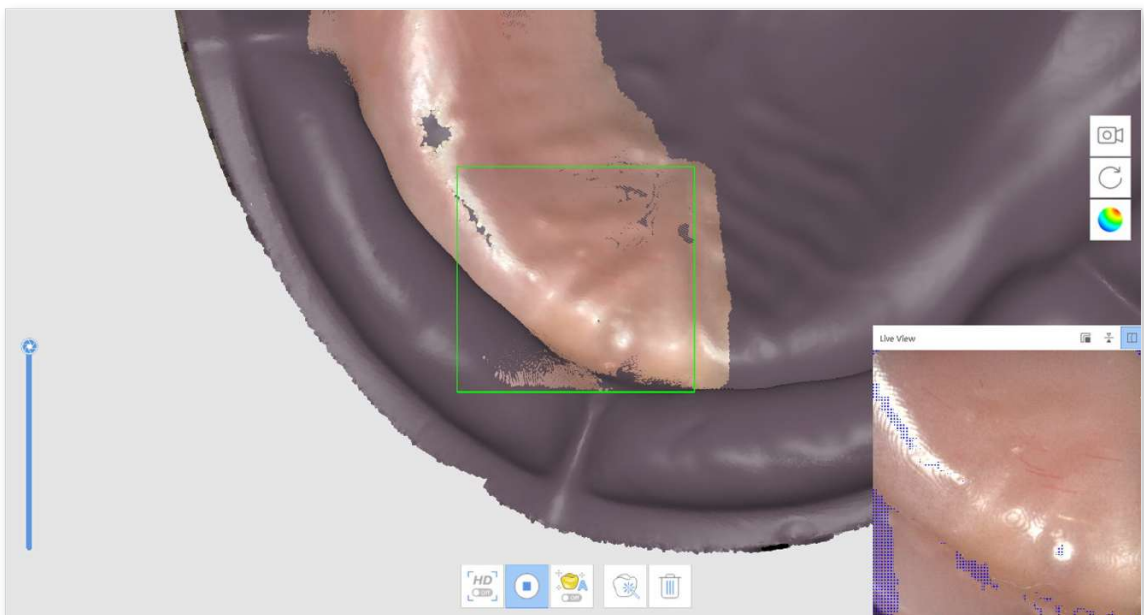

- ③ Scan the denture data in the following order: fitting surface > border > polished surface and artificial teeth.
- ④ Repeat the process for the mandible.
- ⑤ Scan the denture occlusion at the Occlusion scan stage. The data can be utilized in CAD.

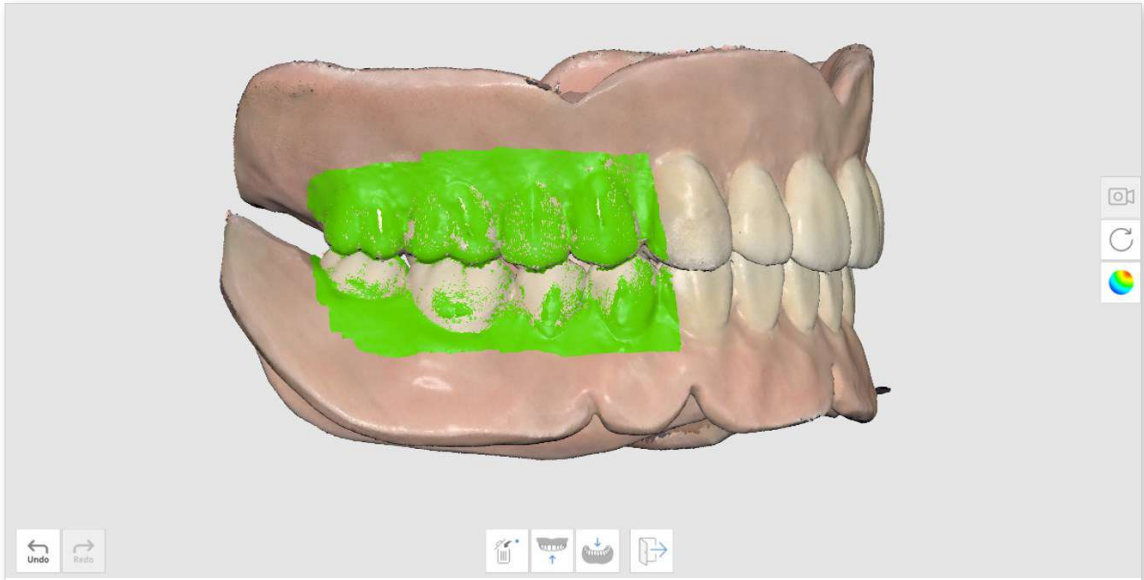

Relined Denture Scan

Scan the denture without acquiring intraoral data from the patient. Scan the fitting surface of the denture at the Edentulous Mandible scan stage and the outer side at the denture stages.

- ① At the Edentulous Mandible scan stage, click "Relined Denture Scan" to scan in reverse mode.

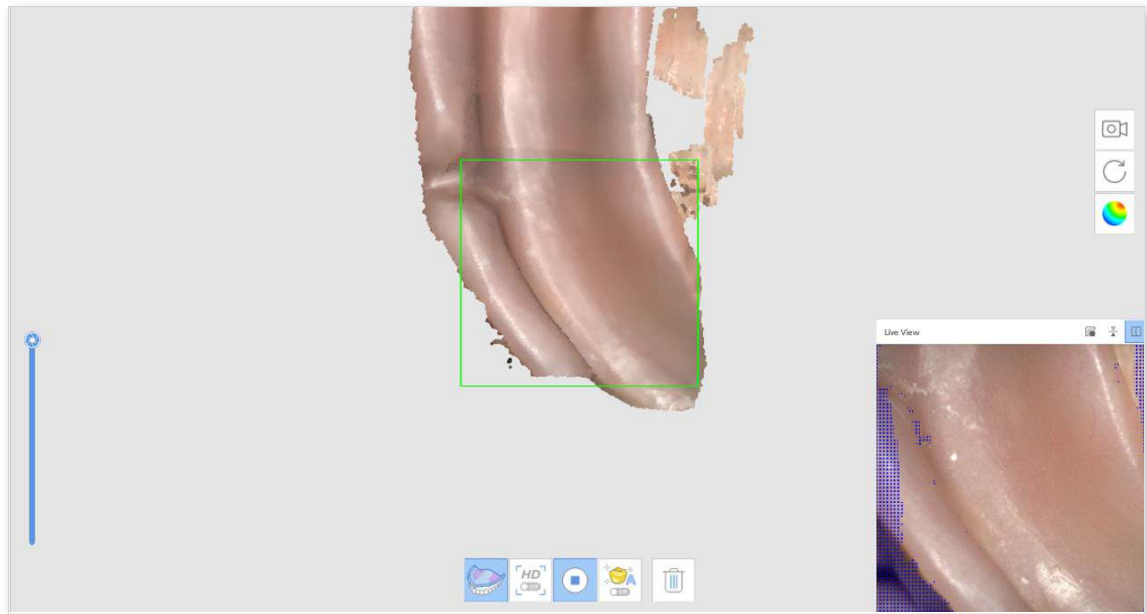

- ② After moving to the next stage, scan the outside of the denture. The data from the previous stage will be copied and reversed since it will be used as the basis for denture alignment.
- ③ Repeat the process for the maxilla.



- ④ Scan the denture occlusion at the Occlusion scan stage. The data can be utilized in CAD.

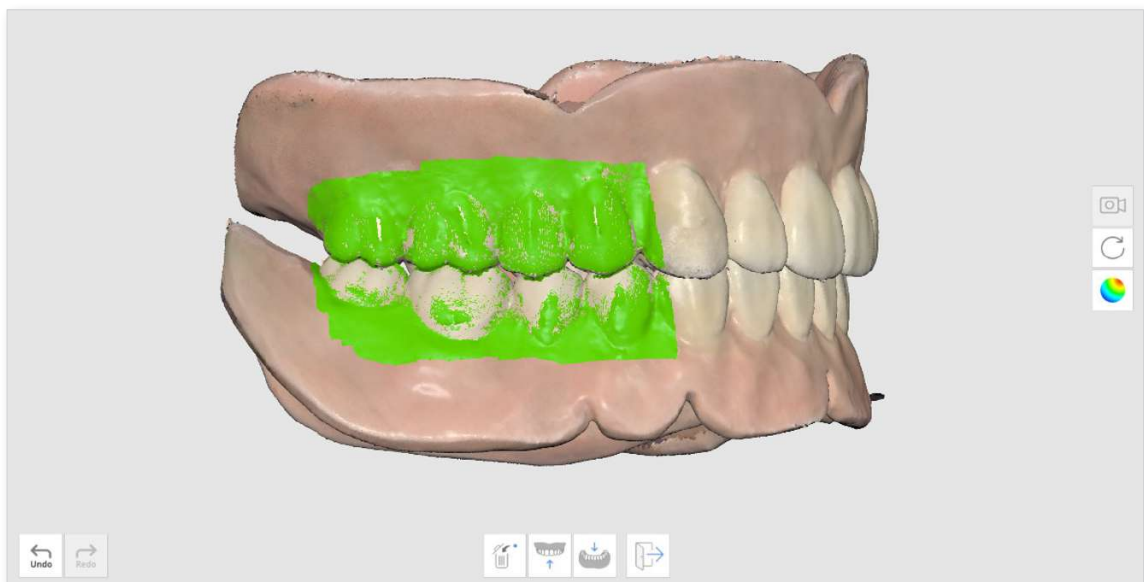

Denture Replica

The following workflow of denture replica appears as Maxillary Denture > Mandibular Denture > Occlusion.



- ① Scan the maxillary denture.



- ② Scan the mandibular denture.



- ③ Scan the denture data in the following order: fitting surface > border > polished surface and artificial teeth.
- ④ Scan the denture occlusion at the Occlusion scan stage. The data can be utilized in CAD.

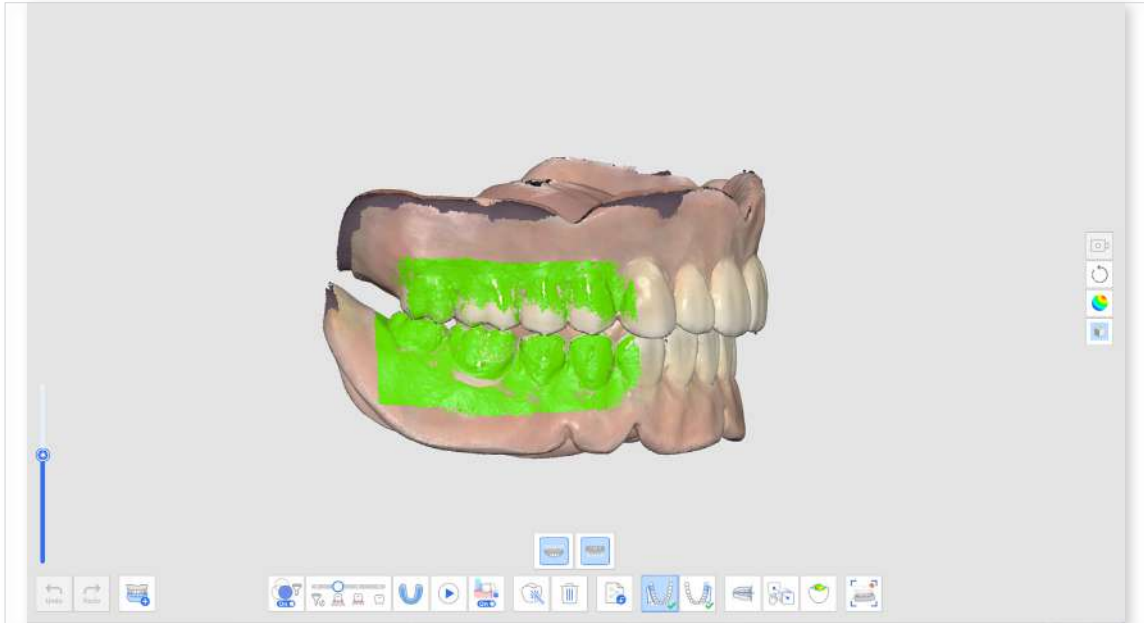

Implant Supported Denture

The following workflow of implant-supported dentures appears as Edentulous Maxilla > Maxillary Denture > Edentulous Mandible > Scan Body > Mandibular Denture > Occlusion.



- ① Acquire the data for the edentulous scan stages.

- ② Scan the scan body at the corresponding scan body scan stage.

Note

Utilize the "Scan Body Library Matching" tool to get precise scan body data from the pre-set library.



- ③ Select a tooth number, find the corresponding scan body data in the library, and click "Confirm."

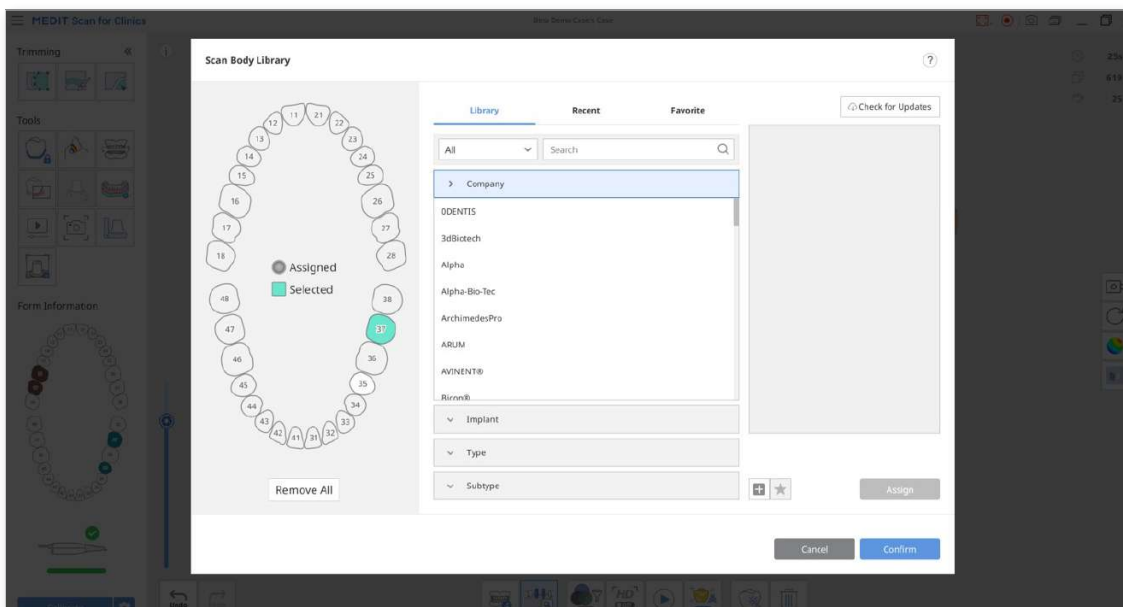

- ④ Scan the denture occlusion at the Occlusion scan stage. The data can be utilized in CAD.

Pre-Op Scan

You can use the pre-op teeth data from the Pre-Op stages as future reference data to create prostheses later.

Once you acquire or import data at the Pre-Op for Maxilla or Pre-Op for Mandible stage, the data is automatically replicated to the Maxilla or Mandible stage when you move on to the next stage.

You can utilize the replicated pre-op data to acquire the prepared data or delete and newly scan the prepared data.

How to Utilize Pre-Op Scan

- ① Scan the mandible (or maxilla) before tooth preparation at the Pre-Op for Mandible (or Pre-Op for Maxilla) scan stage.

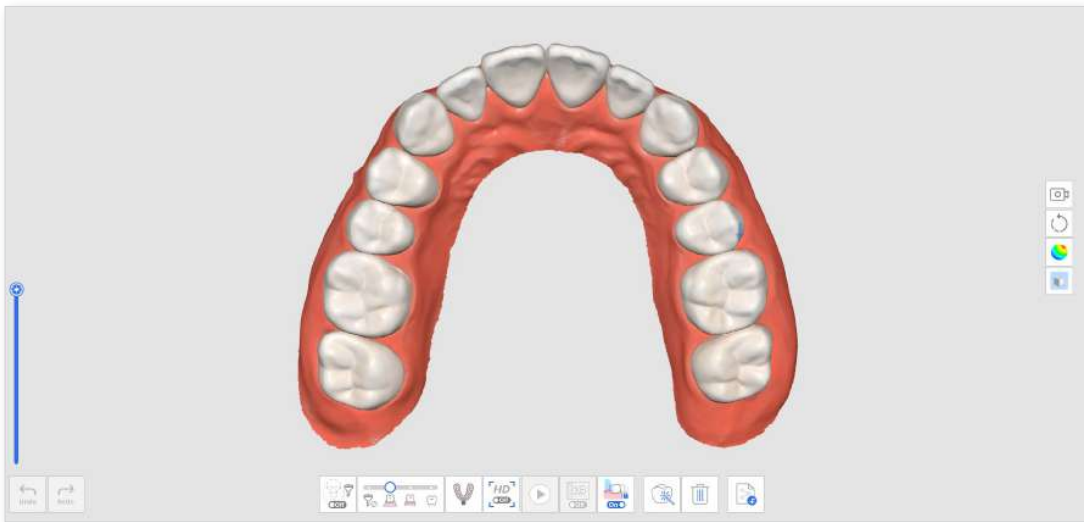

- ② Move to the Mandible (or Maxilla) scan stage. Then the data acquired in the Pre-Op for Mandible (or Pre-Op for Maxilla) stage will be replicated in this stage.

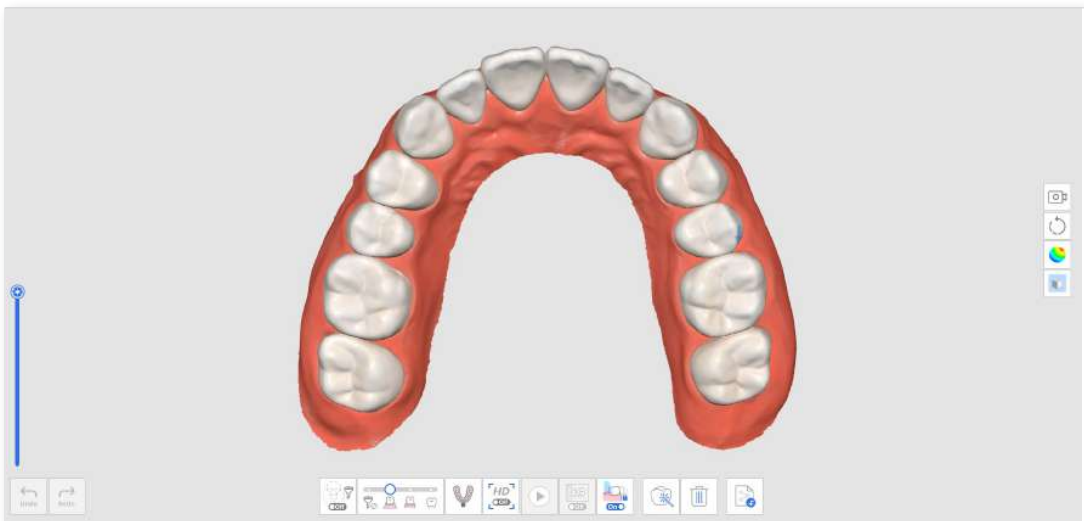

- ③ Scan the mandible after tooth preparation. Start scanning from the area without prepared teeth and continue to scan the prepared teeth to replace the existing data.

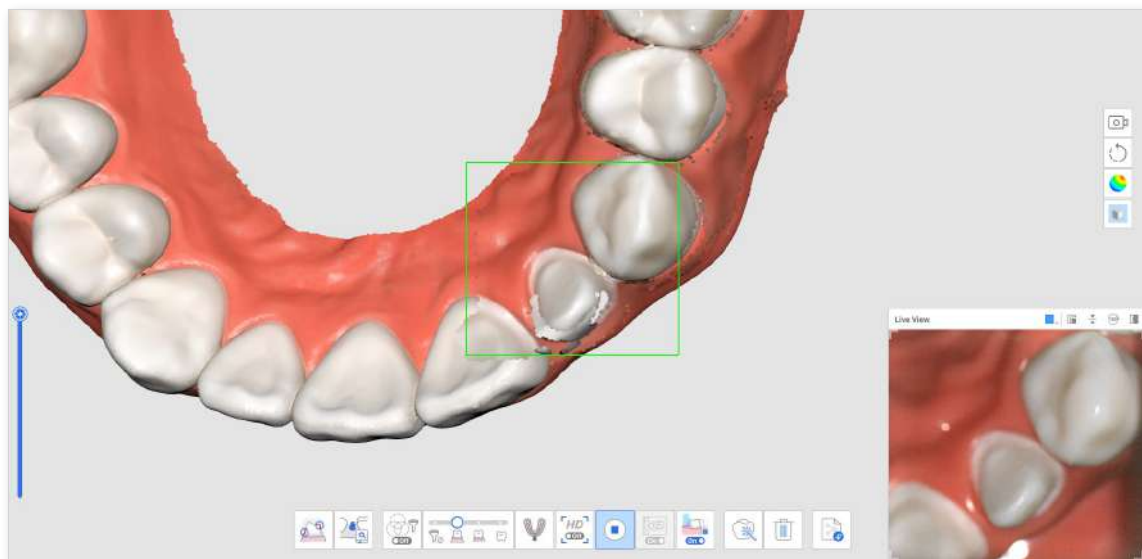

- ④ The image below shows the completed scan.

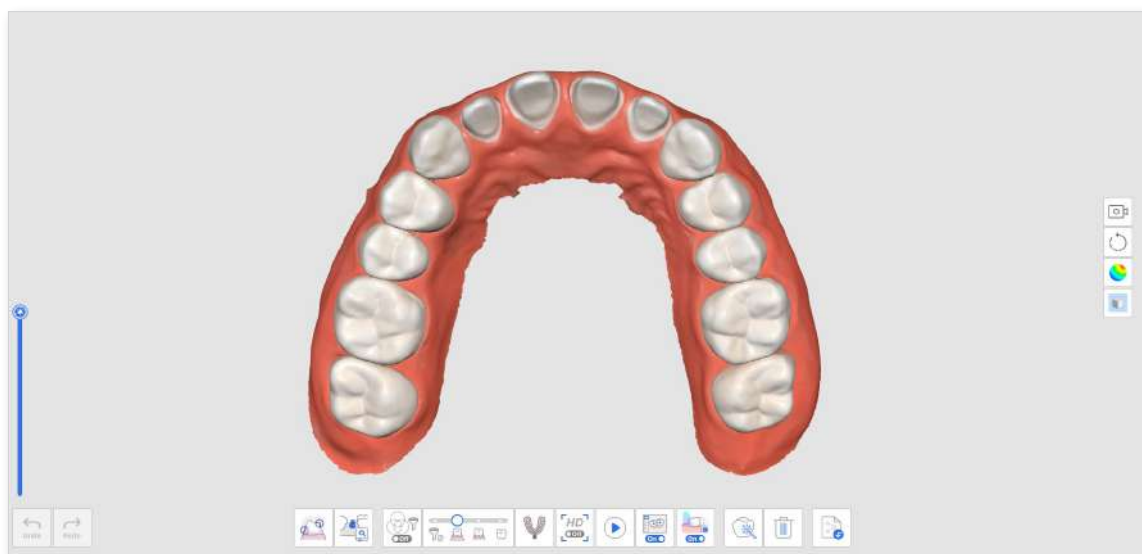

How to Utilize Pre-Op Scan With Trimming Tools

- ① Scan the mandible (or maxilla) before tooth preparation at the Pre-Op for Mandible (or Pre-Op for Maxilla) scan stage.

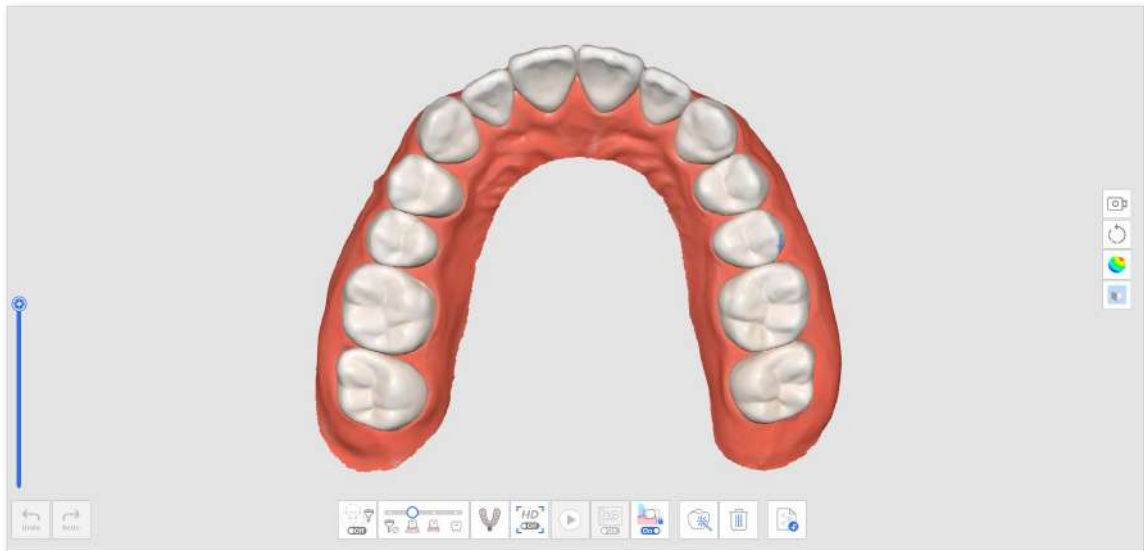

- ② Move to the Mandible (or Maxilla) scan stage. Then, the data acquired in the Pre-Op for Mandible (or Pre-Op for Maxilla) stage will be replicated.

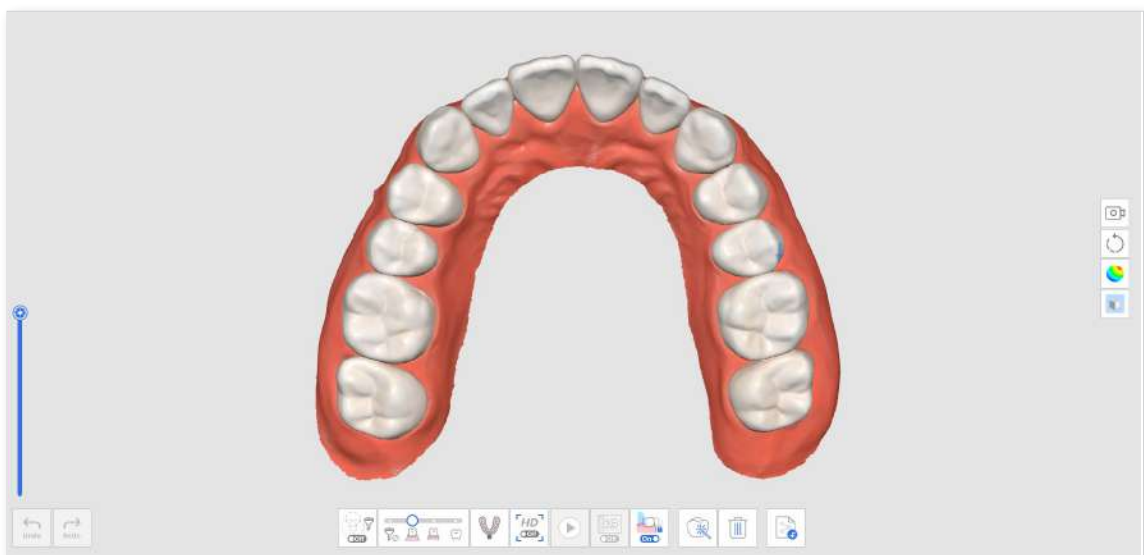

- ③ Use trimming tools to delete the data where prepared teeth are located.



- ④ When you try to exit from Trimming Tools, you will be asked to lock the data. Click "Yes" to lock the existing data to protect them during additional scans.

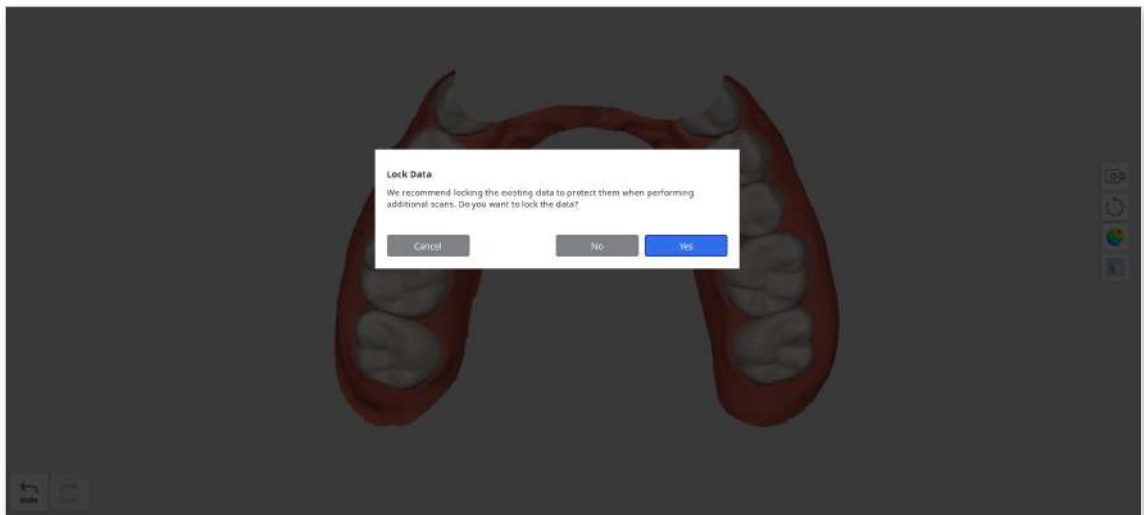

- ⑤ The locked data is presented in a different color, and this will prevent any unwanted changes.

- ⑥ Acquire additional scan data in the prepared teeth area.

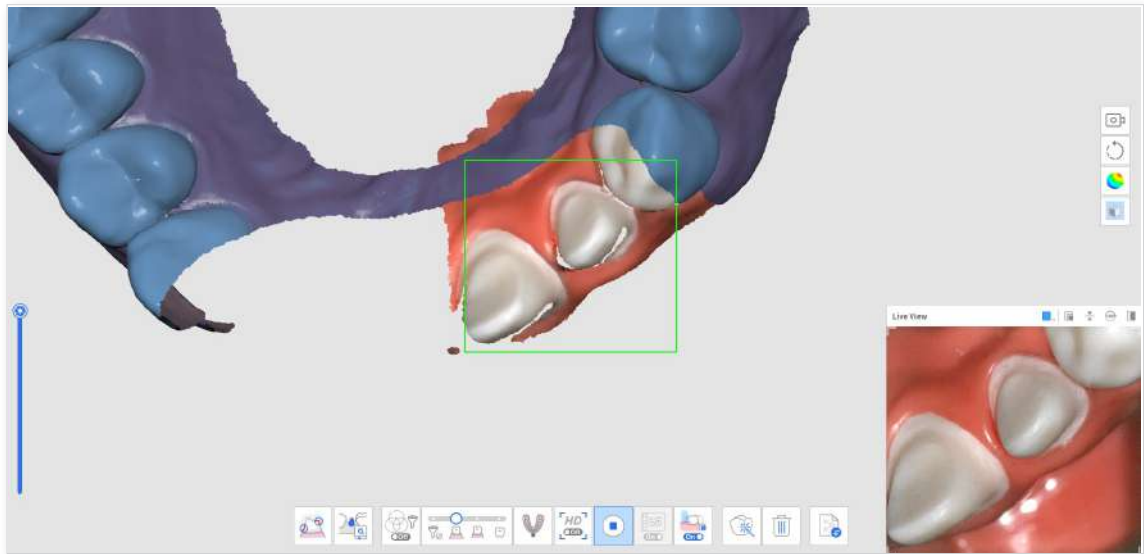

- ⑦ The image below shows the completed scan.

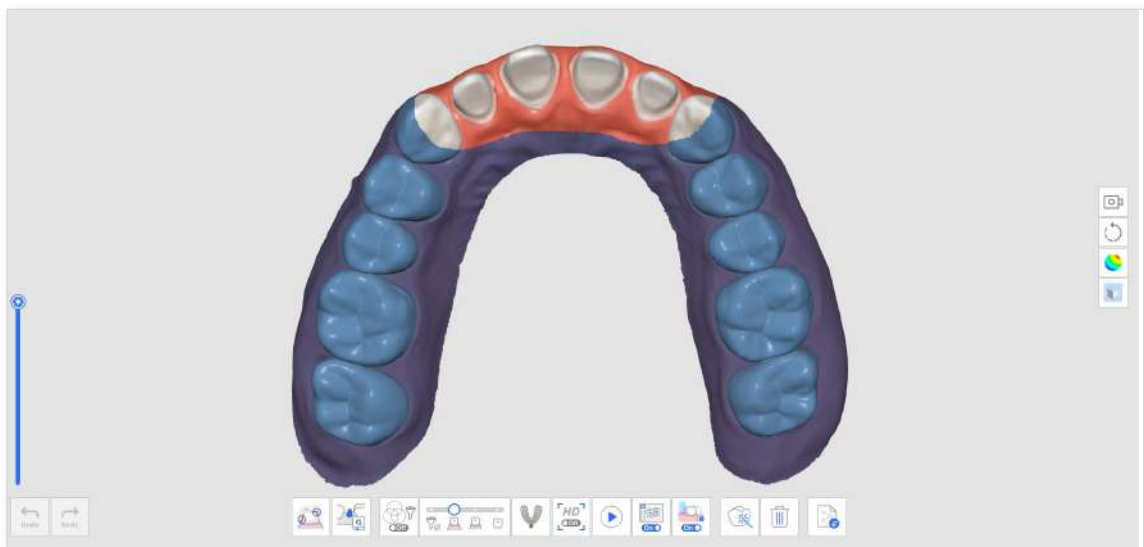

How to Delete Replicated Pre-Op Scan and Scan New Data

- ① Scan the mandible (or maxilla) before tooth preparation at the Pre-Op for Mandible (or Pre-Op for Maxilla) scan stage.

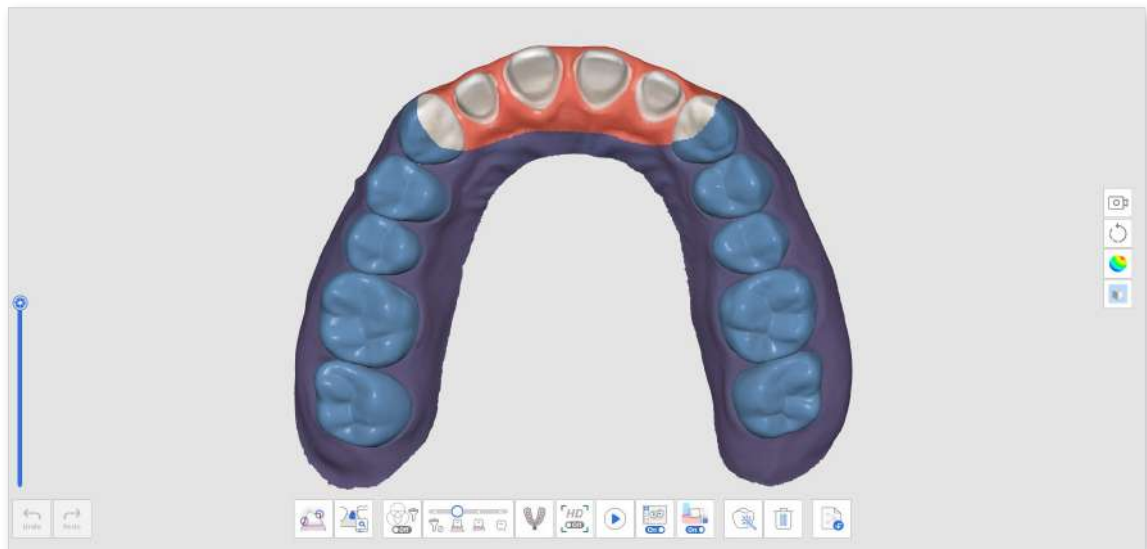

- ② Move to the Mandible (or Maxilla) scan stage. Then, the data acquired in the Pre-Op for Mandible (or Pre-Op for Maxilla) stage will be replicated.

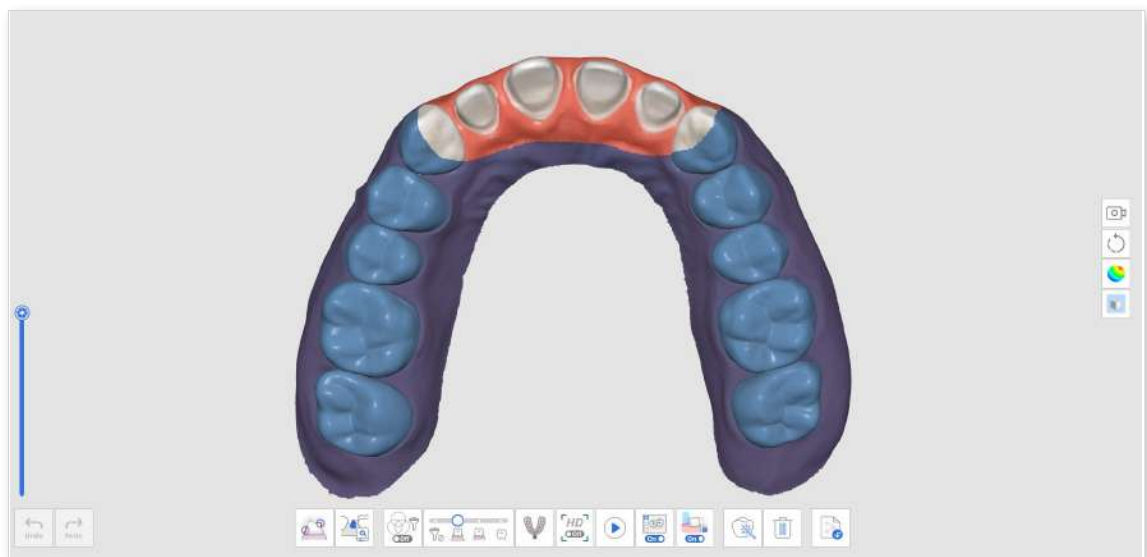

- ③ Click the "Delete" icon at the bottom.



- ④ Click the "Delete and Scan New Data" button.

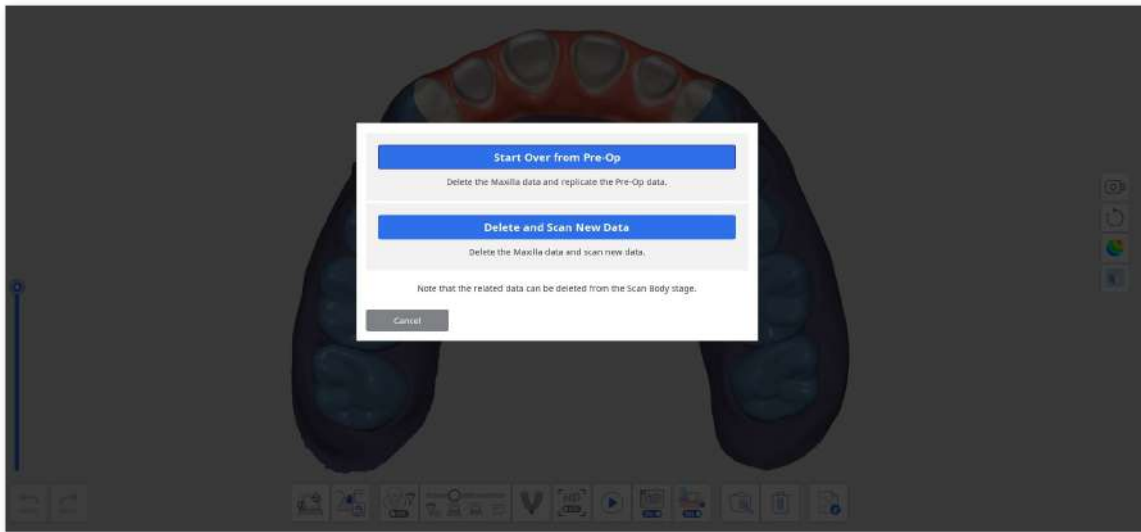

- ⑤ The data will be deleted as below.

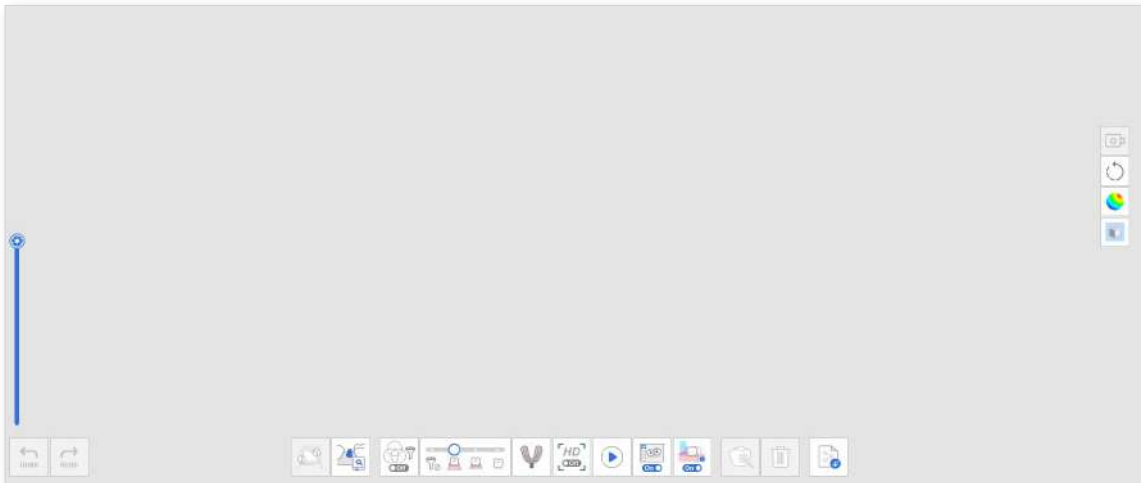

- ⑥ You can now scan the prepped teeth data.

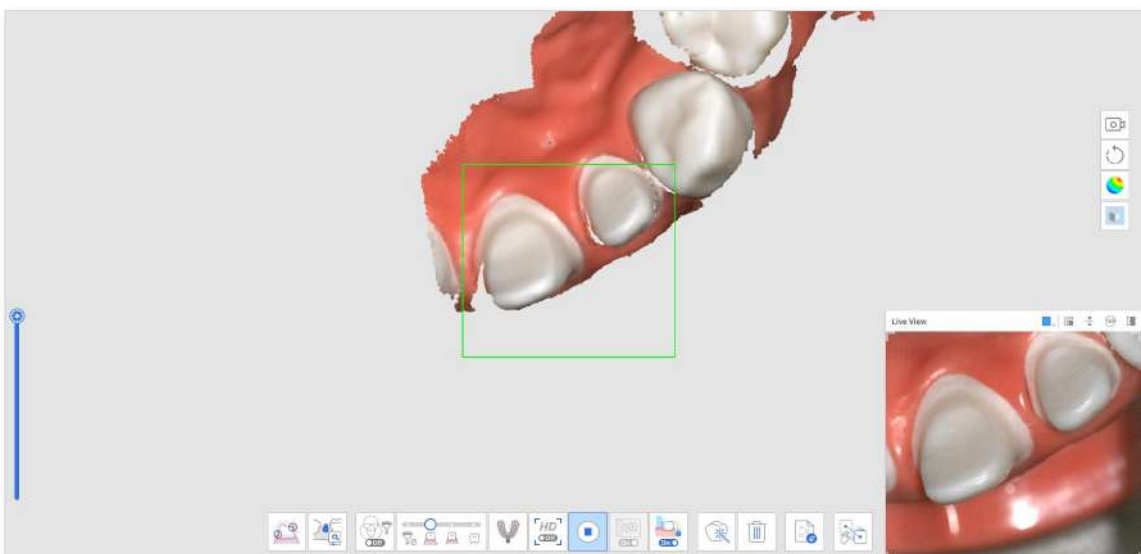

- ⑦ The image below shows the completed scan.

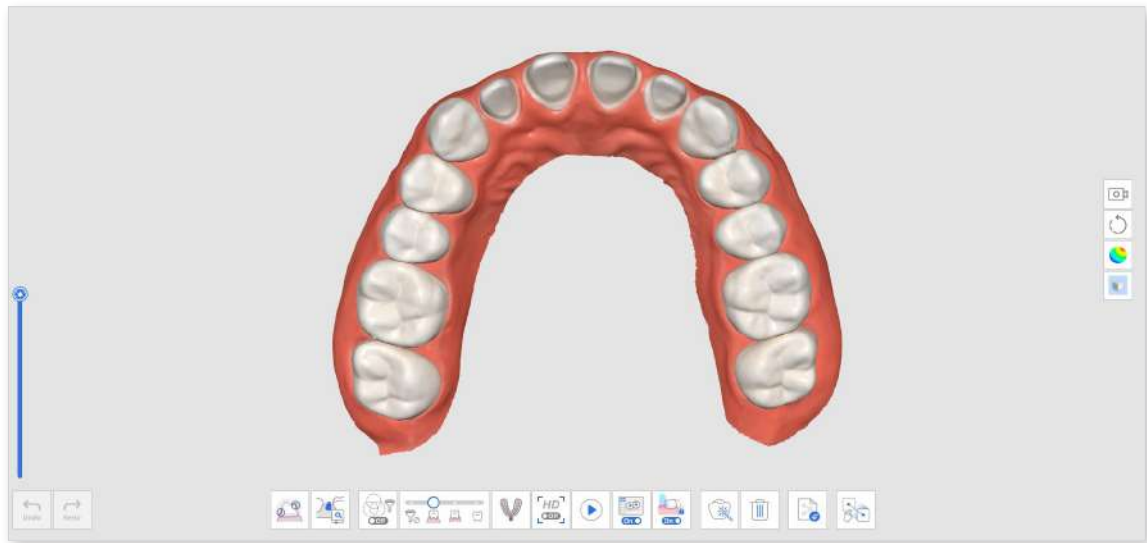

- ⑧ Click the "Manual Alignment" icon at the bottom to manually align the Pre-Op for Mandible (or Pre-Op for Maxilla) data with Mandible (or Maxilla) data.



- ⑨ You will see both pre-op and prepared data in the data display area.

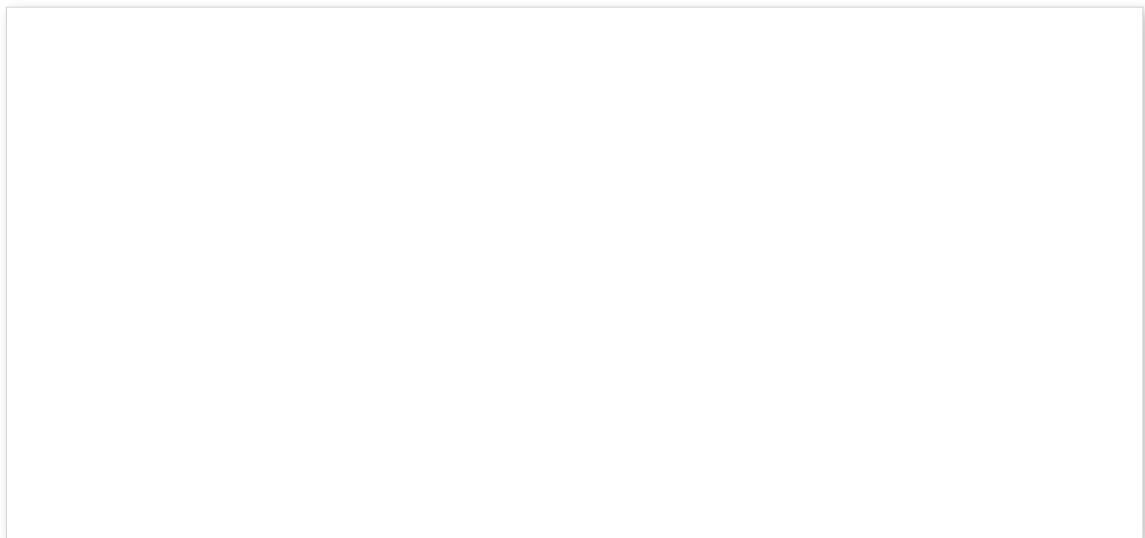

- ⑩ Place up to three points to align the data.

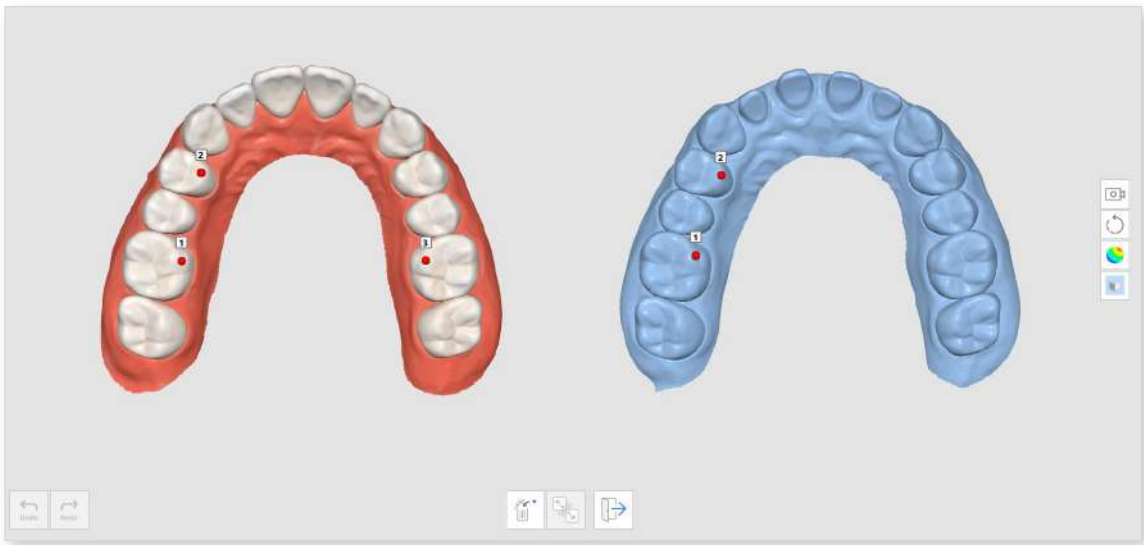

- ⑪ The image below shows the completed scan.



Impression Scan

The Impression Scan provides a seamless scanning process, utilizing both intraoral and impression scans.

You can acquire and merge intraoral and impression scan data in this stage.

How to Acquire Impression Scan

- ① Scan intraoral scan data in the Maxilla or Mandible stage.



- ② Click the "Impression Scan" icon at the bottom.



- ③ Mark the area to replace intraoral data with impression data.

Note

This function is useful to limit the area to be replaced.

If the user skips the marking process, the entire data will be replaced by the impression data.



- ④ Scan the impression model for the marked area. The impression data will be aligned with intraoral data automatically.



- ⑤ With the "Impression Scan" feature turned on, use the trimming tools to display only impression data.



- ⑥ Delete any unnecessary areas in the impression data.



- ⑦ The result will appear as shown below.



How to Utilize Impression Scan for Margins

- ① Scan intraoral scan data in the Maxilla or Mandible stage.

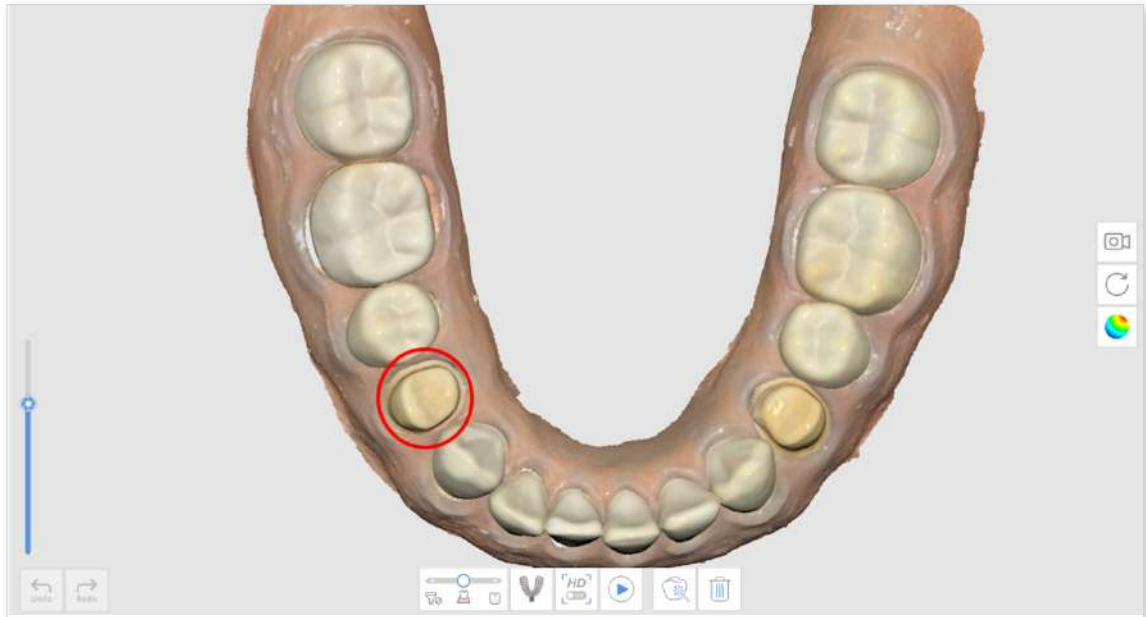

- ② Click the "Impression Scan" icon at the bottom.



- ③ Mark the margin area with a trimming tool.



- ④ Scan the impression.



- ⑤ The result will appear as shown below.

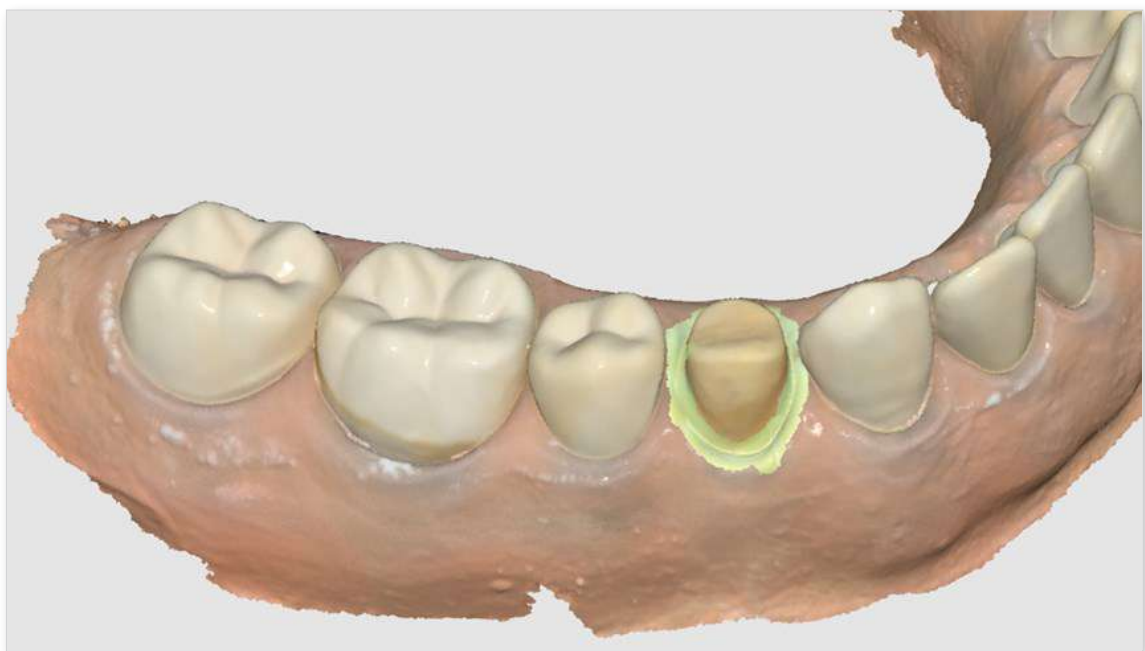

How to Utilize Impression Scan for Post & Core Case

In some cases of Post & Core, it is very difficult to get the data for the post area due to the area being very deep and hard to scan. The "Impression Scan" feature is useful for these cases.

- ① Prepare the base model and impression for the post.

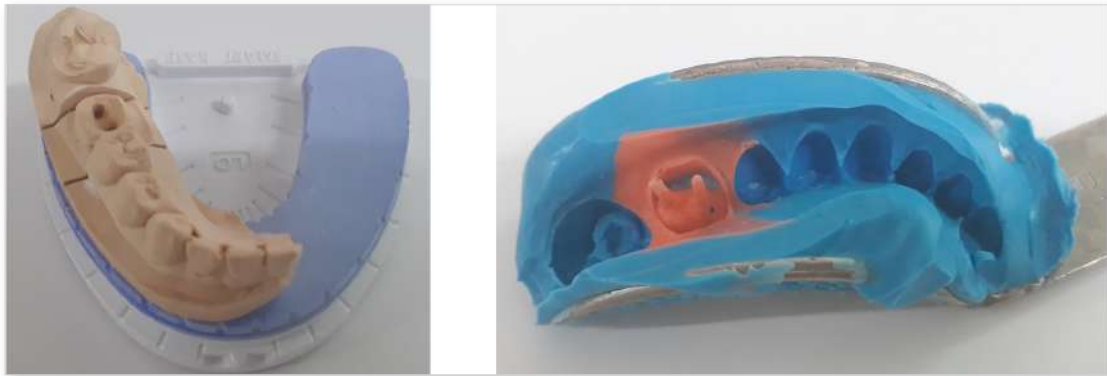

- ② Scan the base model. You can see that the post area is deep and not fully scanned.

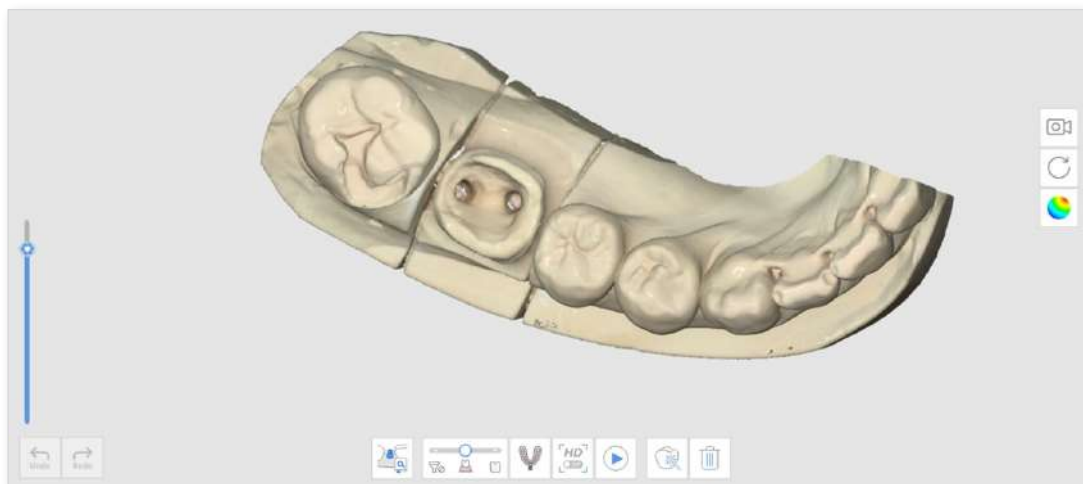

- ③ Click the "Impression Scan" icon and scan the impression model.

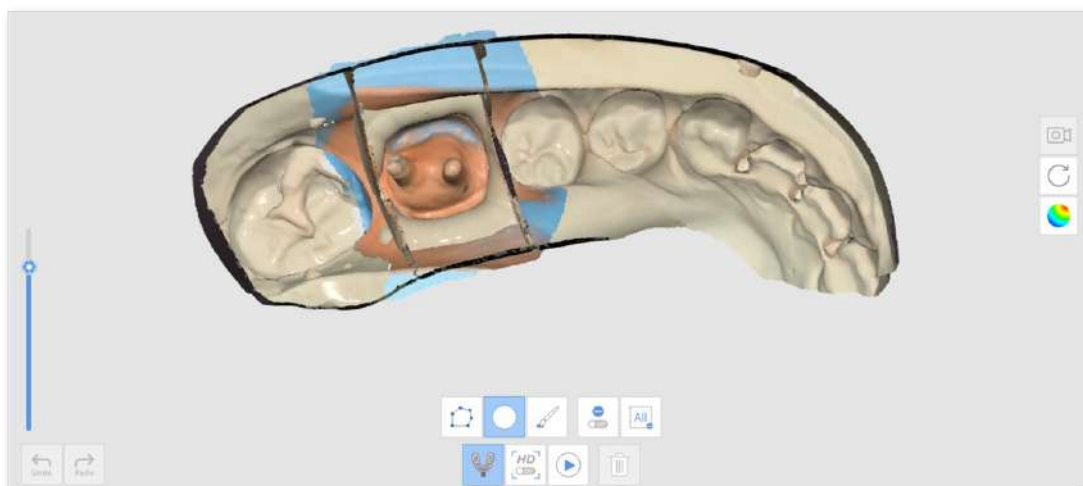

- ④ The result will appear as shown below.

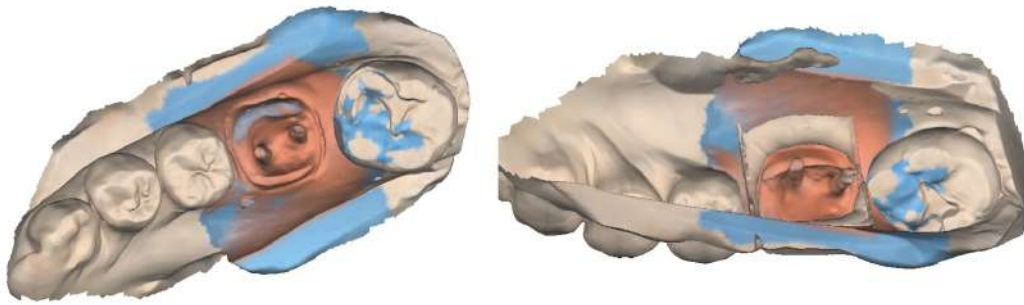

How to Utilize Impression Scan for Occlusion Case

You can use the "Impression Scan" feature for occlusion alignment.

- ① Prepare the impression model.



- ② Scan the maxilla and mandible in the Maxilla and Mandible stages.

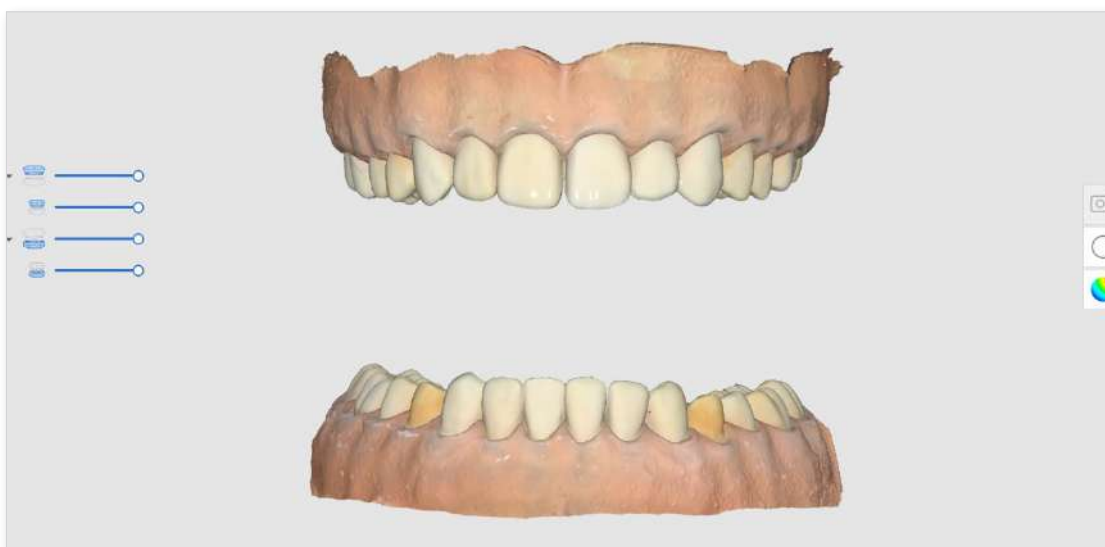

- ③ Click the "Impression Scan" icon at the Occlusion stage.



- ④ Acquire the occlusion data using the impression model. In this case, the impression must be scanned from all angles of 360 degrees for each bite.

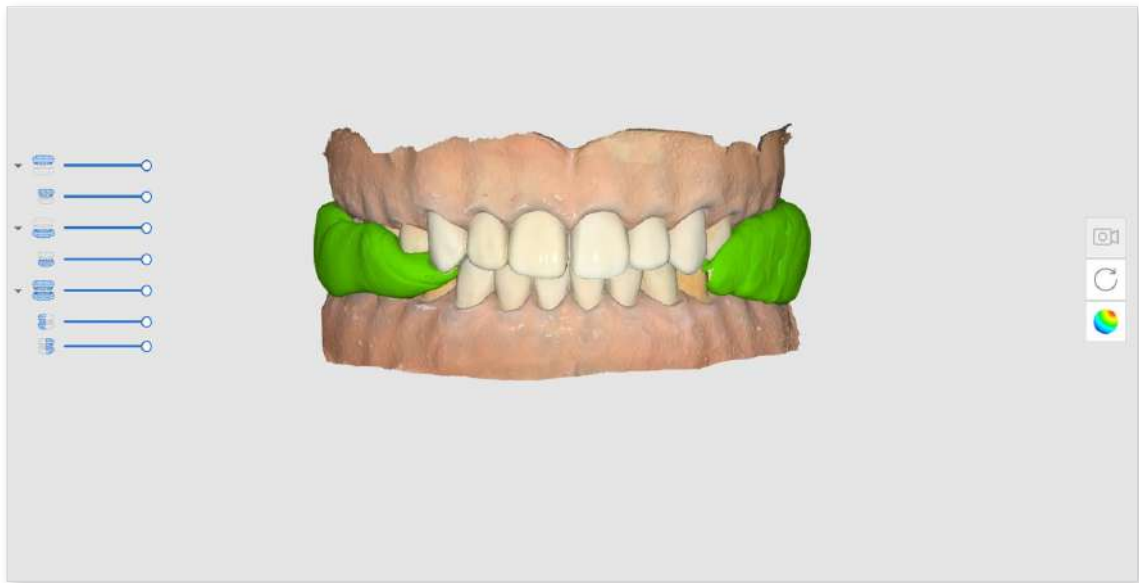

 **Note**

The High Resolution Scan feature is available in Impression Scan.

When impression data is acquired with high resolution, it will be shown in different colors if the Model Display Mode is set to "Texture Off."

Abutment Library Matching

Note



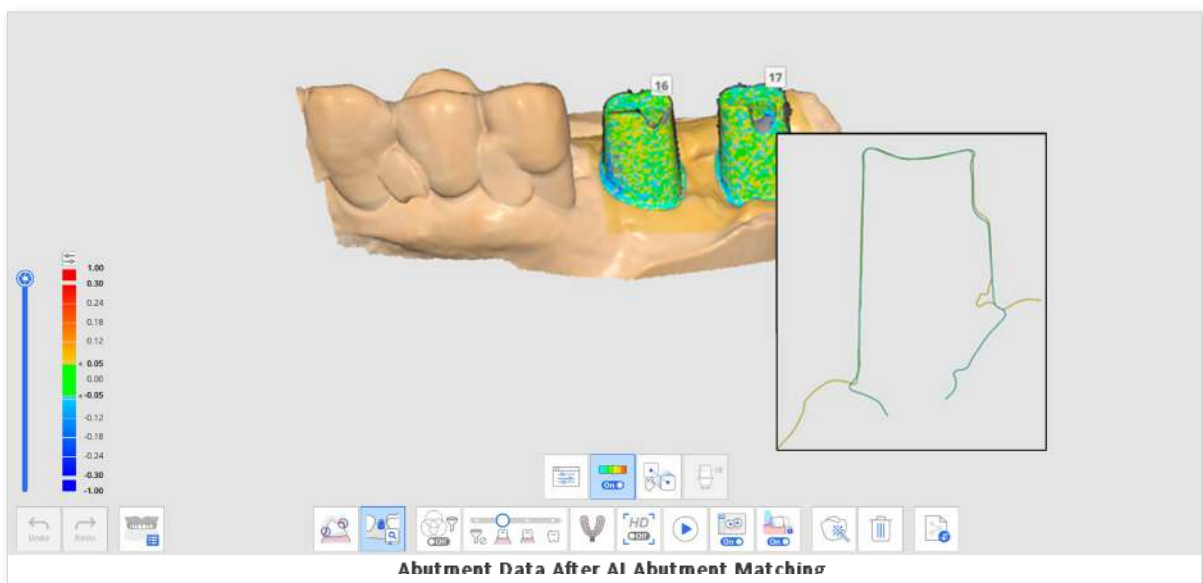
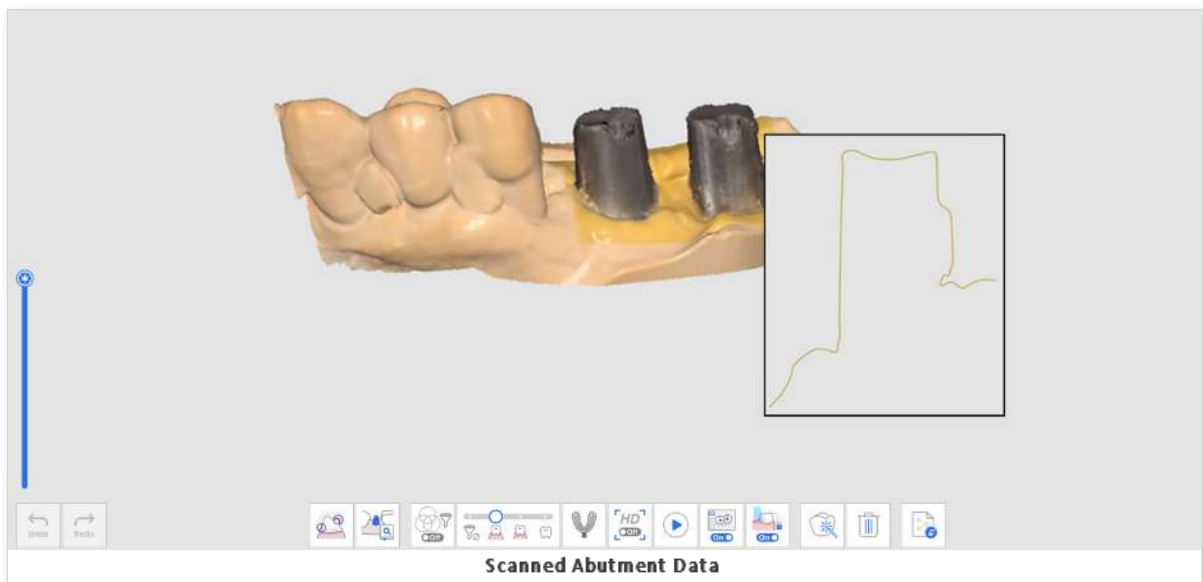

Refer to [Tools and Functions > Main Toolbar Tools > Function Tools > Register Abutments](#) on how to register abutments in the library.

You can register custom or ready-made abutments with adjusted length, angle, etc.

You can use the library to substitute acquiring data for areas that may be difficult to reach, such as abutment margin areas located below the gingiva or areas too close to the adjacent teeth.

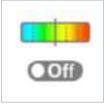

The following tools are provided for the Abutment Library Matching feature.

	Tooth Number	Allow users to select an individual tooth number for the data acquisition target.
	Abutment Library	Assign library data for each tooth and manage the library data.
	Show/Hide Deviation	Show or hide the deviation between aligned data using a color map.
	Manual Alignment	Allow users to align the library data and scan data manually. You can align data with one or three alignment points.
	Cut Abutment Manually	Cut the abutment by adjusting the height manually.

How to Use Abutment Library Matching

Assign Abutment Library

Before you scan the abutment data, you must assign the desired library to each tooth number.

- ① Acquire data in the Maxilla or Mandible stage.



- ② Click the "Abutment Library Matching" tool icon at the bottom of the Maxilla or Mandible stage.



- ③ Click the "Abutment Library" icon.



- ④ The following dialog appears to define the abutment library for each tooth.

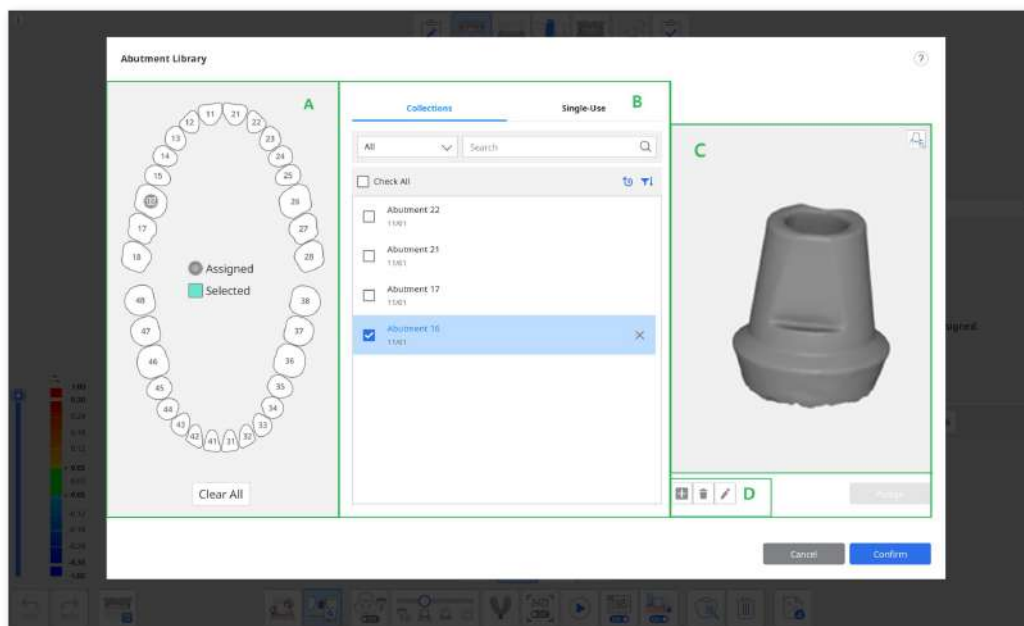

Note

The following two tabs are provided in section B for abutment library selection.

- Collections: The list of abutment libraries registered as collections so that they can continue to be used in multiple cases.
- SingleUse: The list of abutment libraries registered as singleuse so that they can only be used in the case.

- ⑤ Select a tooth or multiple teeth from section A and select a library in section B.
 - You can add a new library by clicking the "+" button below the preview image. Files in STL, OBJ, and PLY formats are supported to register.
 - You can also delete the selected case or edit a case name by clicking the "Delete" or "Edit" button below the image.
- ⑥ Check the selected library in the 3D preview in section C. You can rotate, move, zoom in, and zoom out.

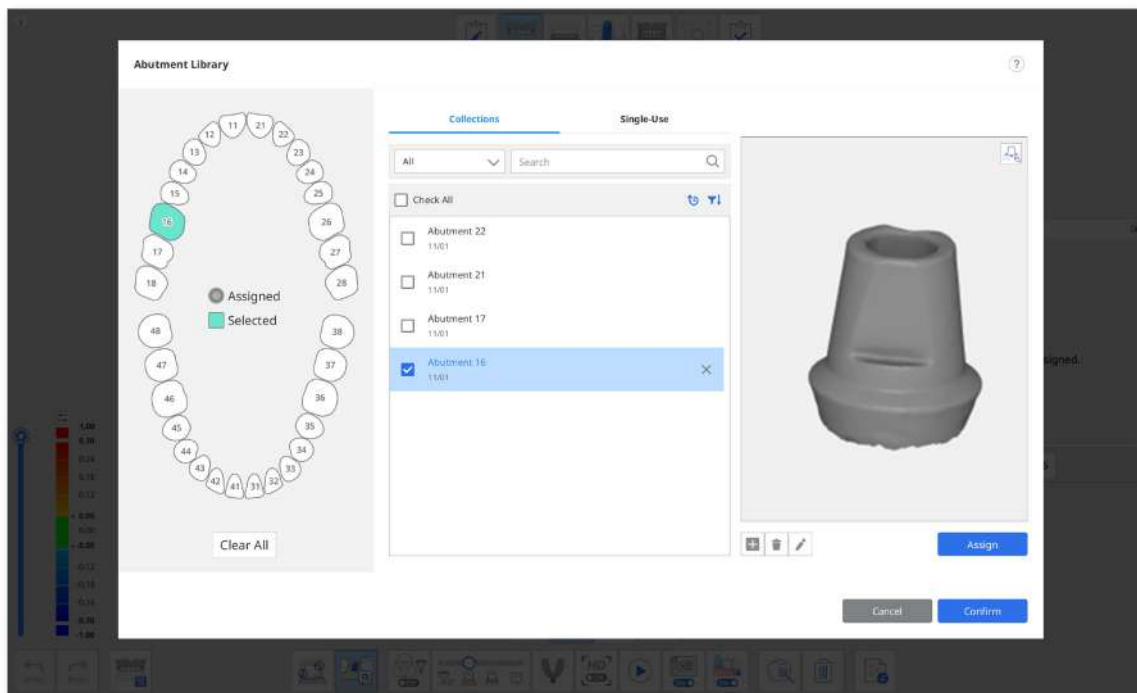

- ⑦ You can also register the abutment with a margin line by clicking the Margin Line icon on the upper right corner of the preview.

Note

Refer to [Tools and Functions > Main Toolbar Tools > Function Tools > Margin Line](#) for detailed information on how to draw a margin.

- ⑧ Click "Assign" to assign the selected abutment to the selected tooth number.
- ⑨ After assigning all required libraries, click "Confirm."

Align Abutment Library

Once you assign a library to a tooth number, the Abutment Library Matching will automatically align the library to the scan data while scanning.

- ① Turn on the "Abutment Library Matching" tool at the bottom of the screen.
- ② While scanning the data, the program automatically attempts to align the library you assigned for the tooth number to the acquired scan data.

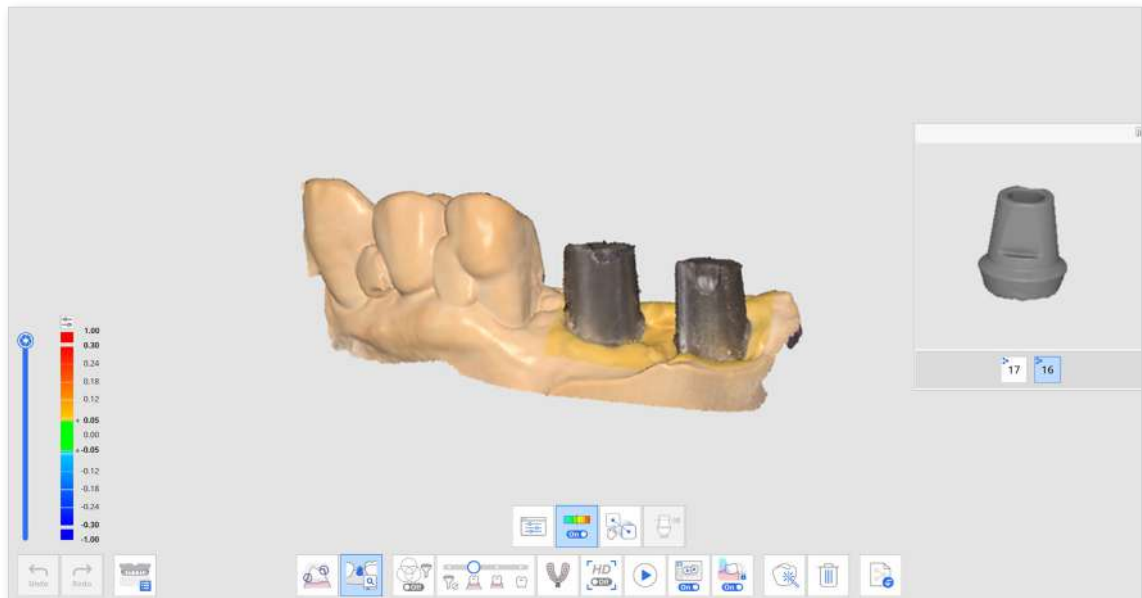

- ③ Once an abutment library is aligned, you can check the scan data and library deviation through the color map.

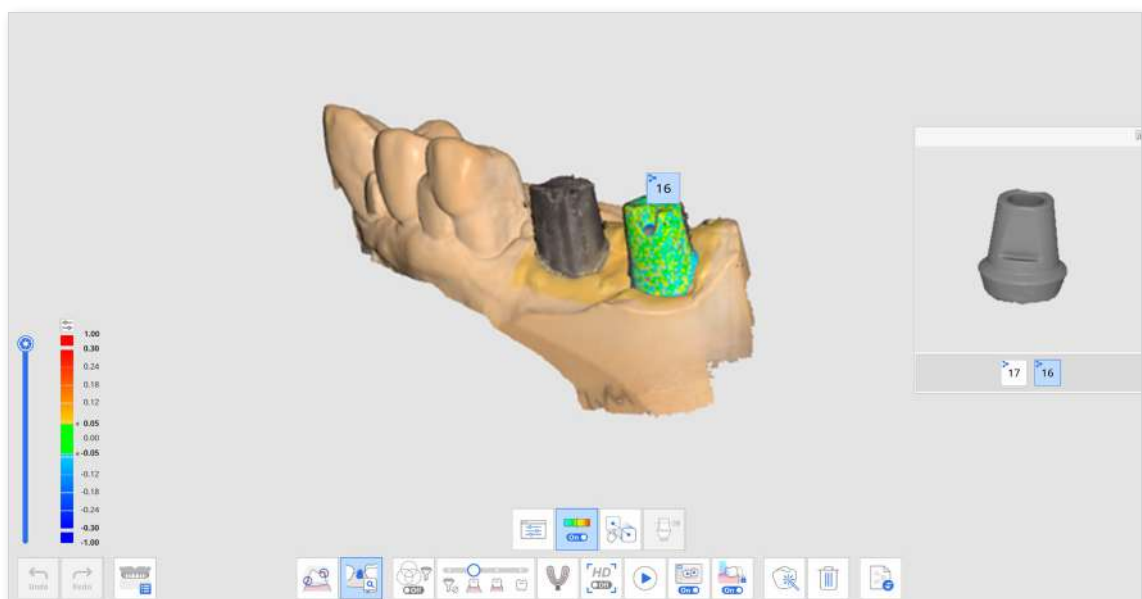

- ④ Repeat to select another tooth number in the preview to align more abutment libraries.

- ⑤ After the scanning, you can manually align any libraries that were not automatically aligned during the scan.
- ⑥ Click the "Manual Alignment" icon.



- ⑦ Click one to three corresponding alignment points on the library data for the selected tooth number in the library preview and the scan data.



- ⑧ After completing manual alignment, click "Exit" to check the aligned libraries.
- ⑨ If abutments are touching each other when fastened together, you can use the "Data Group for Library Alignment" icon at the bottom. With this feature, you can create a new data group to acquire scan data and align the abutment libraries assigned to each tooth number.

Scan Body Library Matching

The Scan Body Library Matching feature is useful when scanning difficult-to-reach areas, such as a narrow implant area or metal scan body materials.

By scanning the scan body fastened to the implanted fixture, you can replace the scan body data with the library data to reproduce the position and angle of the implant.

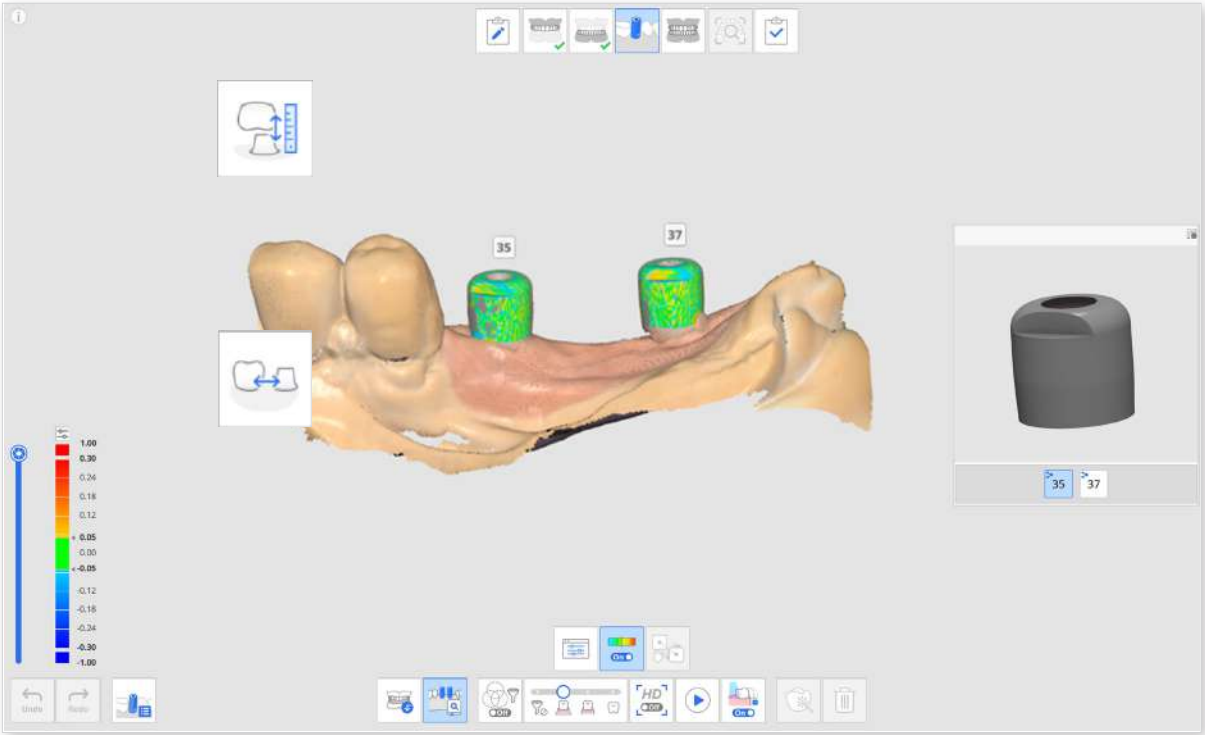

The following tools are provided for the Scan Body Library Matching feature.

	<p>Tooth Number</p>	<p>Allow users to select an individual tooth number for the data acquisition target.</p>
	<p>Scan Body Library</p>	<p>Assign library data for each tooth and manage the library data.</p>
	<p>Show/Hide Deviation</p>	<p>Show or hide the deviation between aligned data using a color map.</p>
	<p>Manual Alignment</p>	<p>Allow users to align the library data and scan data manually. You can align data with one to three alignment points.</p>

How to Use Scan Body Library Matching

Assign Scan Body Library

Before you acquire the scan body data, you must assign the desired library to each tooth number.

- ① Acquire data in the Maxilla or Mandible stage before fastening the scan body.

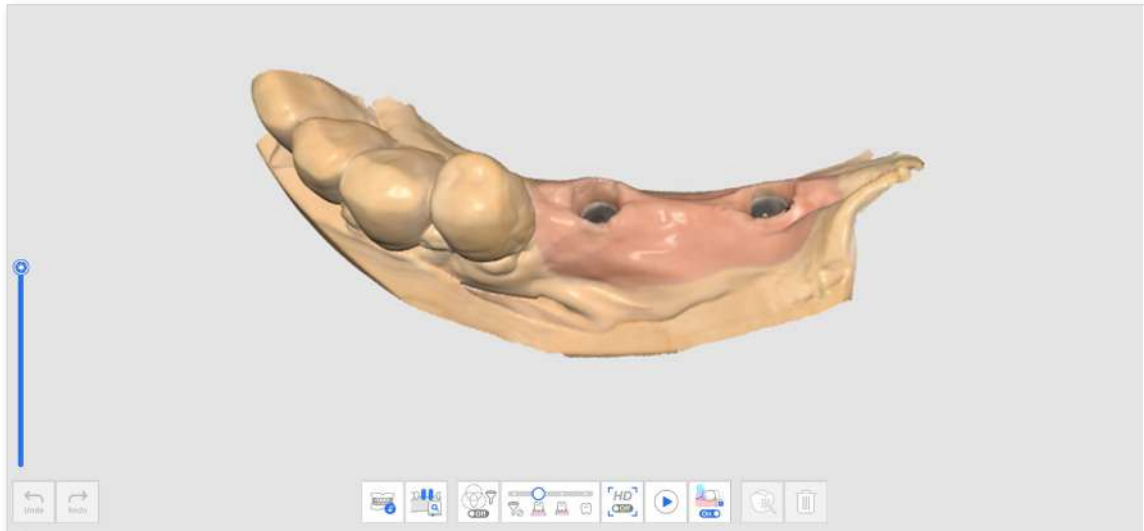

- ② Move to the Scan Body stage and obtain scan data after fastening the scan body.
- ③ Click the "Scan Body Library Matching" tool icon at the bottom of the screen.

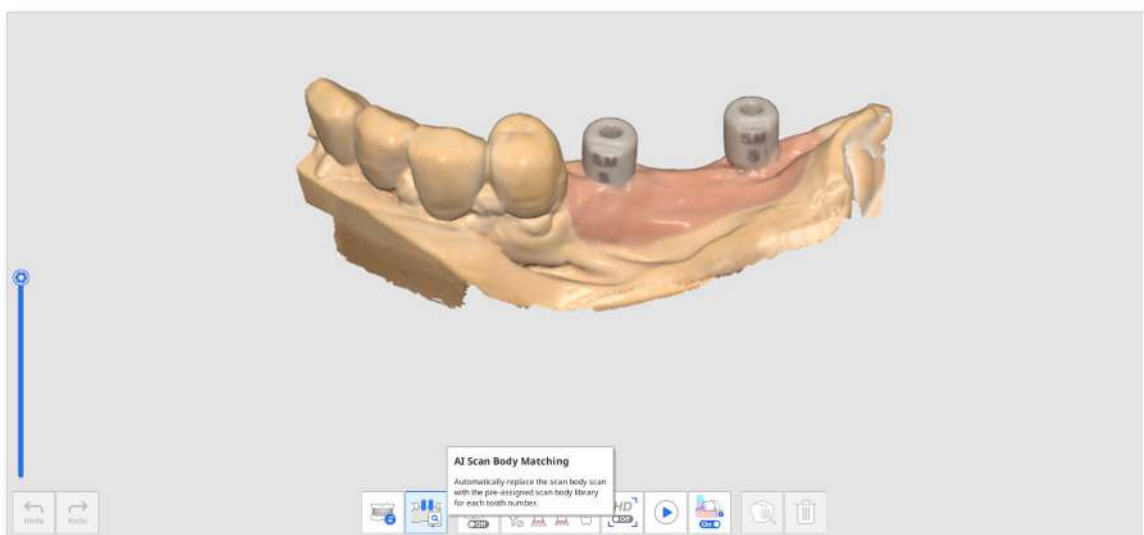

- ④ Click the "Scan Body Library" icon.



- ⑤ The following dialog appears to define the scan body library for each tooth.

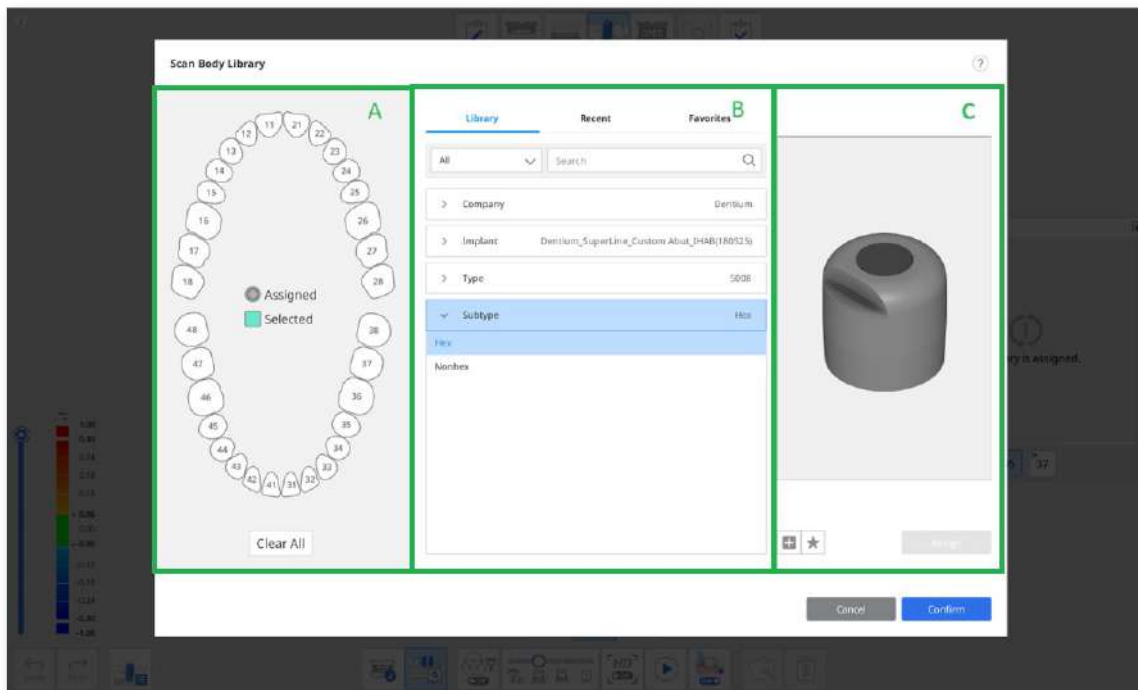

Note

The following three tabs are provided in section B for scan body library selection.

- Library: All registered scan body libraries are listed by Company, Implant, Type, and Subtype. You can search for scan body libraries by entering their name.
- Recent: The most recently used scan body libraries are listed with the date of last use.
- Favorite: The starred scan body libraries are listed. You can add a scan body library to the Favorite tab for easy access by clicking the "Add to Favorite" icon below the preview image.

- ⑥ Select a tooth or multiple teeth from section A and then select a library in section B to assign.

Note

You can add a new library by clicking the "+" button below to preview the image. Files in STL, OBJ, and PLY formats are supported to register.

- ⑦ Check the selected library in the 3D preview. You can rotate, move, zoom in, and zoom out.

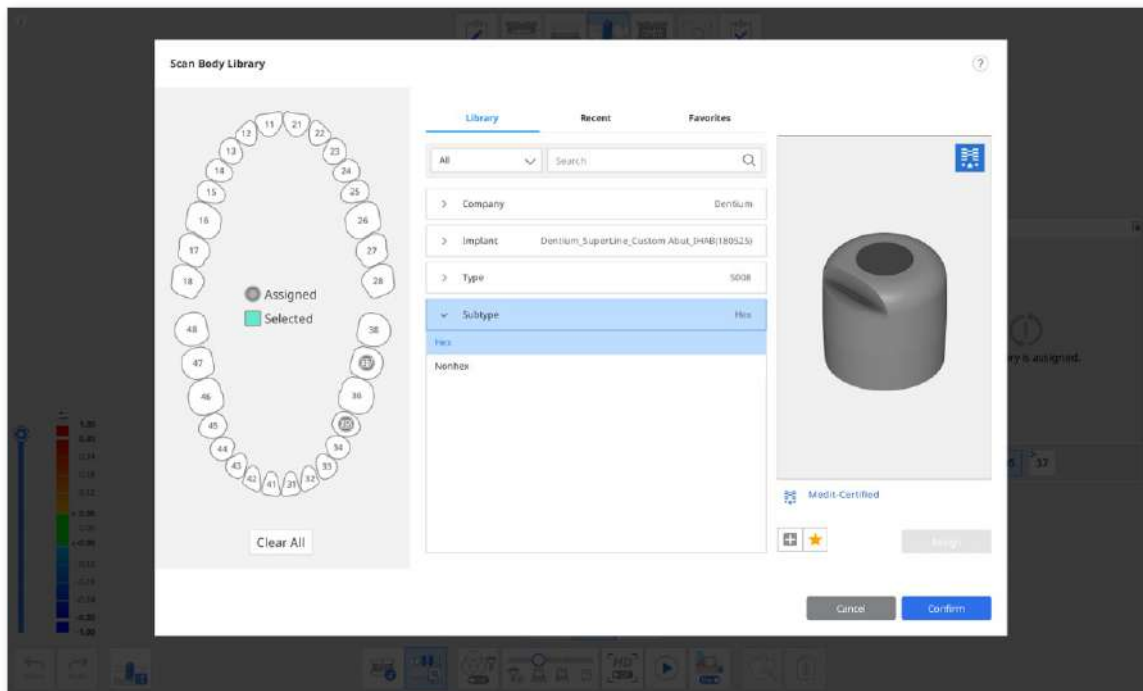

Note

Medit-Certified

The scan body libraries with the Medit logo on the upper right corner apply an algorithm optimized for scan body library alignment to minimize the impact of scan error due to the processing and material of the scan body manufacturer.

- ⑧ Click "Assign" to assign the selected scan body to the tooth number.
- ⑨ After assigning all required libraries, click "Confirm."

Align Scan Body Library

Once you assign a library to a tooth number, the Scan Body Library Matching will automatically align the library to the acquired data while scanning.

- ① Turn on the "Scan Body Library Matching" tool at the bottom of the screen.

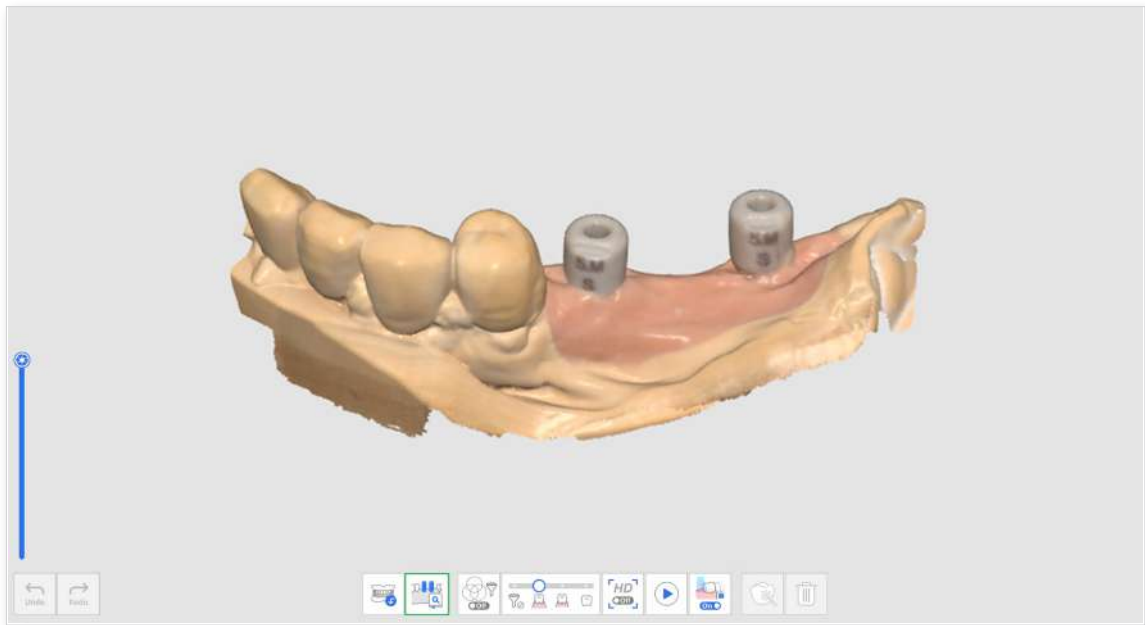

- ② While scanning the scan body data, the program automatically attempts to align the library you assigned for the tooth number to the acquired scan data.
- ③ Once a scan body library is aligned, you can check the scan data and library deviation through the color map.

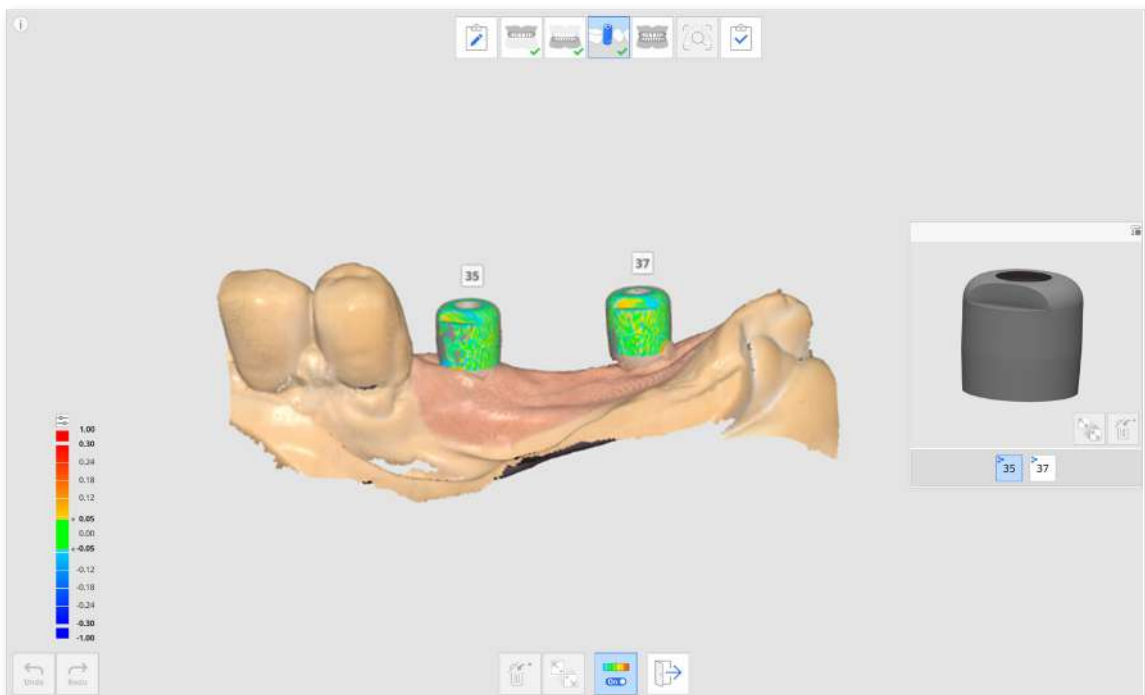

- ④ Repeat to select another tooth number in the preview to align more scan body libraries.
- ⑤ After the scanning, you can manually align any libraries that were not automatically aligned during the scan.
- ⑥ Click the "Manual Alignment" icon.



- ⑦ Click one to three corresponding alignment points on the library data for the selected tooth number in the library preview and the scan data.
- ⑧ After completing manual alignment, click "Exit" to check the aligned libraries.
- ⑨ If scan bodies are too close to each other or touching each other when fastened together, you can use the "Data Group for Library Alignment" icon at the bottom. With this feature, you can create a new data group to acquire scan data and align the scan body libraries assigned to each tooth number.

Preparation Review

The "Preparation Review" icon appears only when the following product has been registered in the Medit Link form.





- Crown
- Pontic
- Post & Core
- Implant Crown
- Post & Core and Crown
- Post & Core and Coping

The Preparation Review icon is located at the bottom of the Maxilla and Mandible stages and is enabled when enough scan images have been acquired in each stage.

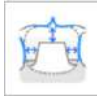

The following tools are available for the Preparation Review feature.

	<p>Preparation Review Settings</p>	<p>Set options for preparation review. This allows users to enter their own values for the criteria to determine if the tooth reduction is insufficient.</p>
	<p>Insertion Path</p>	<p>Calculate the insertion path for the area selected in the prepared data.</p>
	<p>Auto Direction</p>	<p>Automatically calculate and display the insertion path in the direction where the undercut area is minimized.</p>
	<p>Manual Direction</p>	<p>Calculate and display the insertion path in the direction of the user's viewpoint.</p>

	Distances		Mark areas with insufficient tooth reduction compared to the set values.
		Distance to Adjacent	Show the amount of tooth reduction compared to the pre-op data. * Pre-op data must exist and be aligned with prepared data to use this tool.
		Distance to Adjacent	Show the distance between the prepared tooth and its antagonist based on the occlusal alignment data. * Antagonist and occlusion data must exist, and occlusion data must be aligned to use this tool.
		Distance to Adjacent	Show the distance between the prepared tooth and its antagonist. * This tool is available only with prepared data.

How to Use Preparation Review

Preparation Review Settings

Before conducting the Preparation Review, you can set the options and criteria for the feature in the Preparation Review Settings.

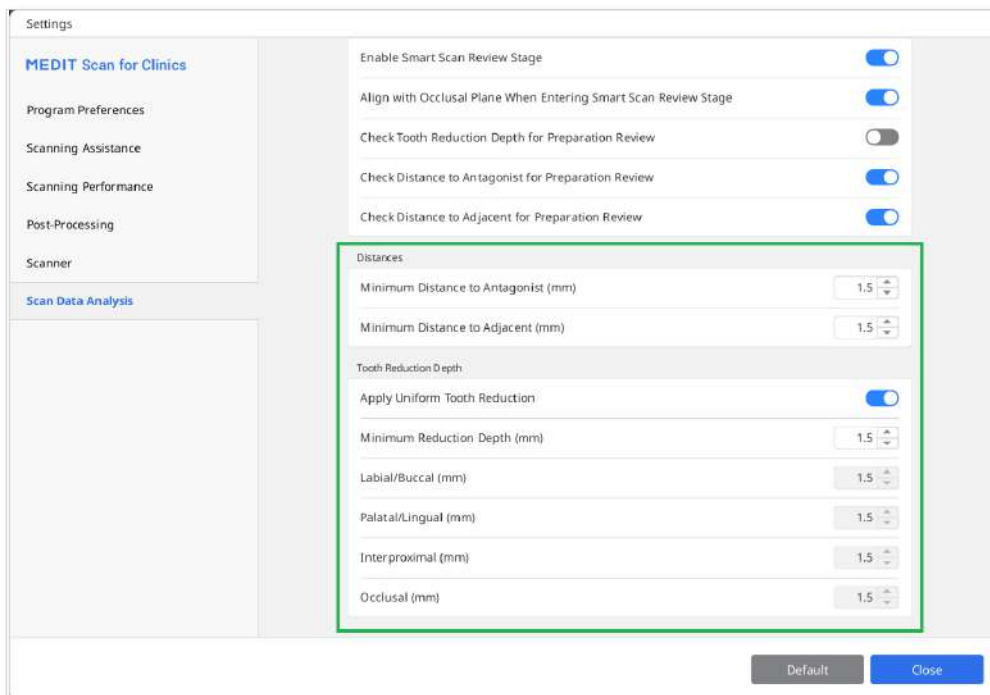

The settings dialog allows users to enter minimum values for distance to the antagonist, distance to the adjacent, and tooth reduction depth to help them establish tooth preparation criteria for treatment and prosthetic fabrication.

Utilizing Preparation Review Tools

- ① Acquired scan data in the Maxilla or Mandible stage and click the Preparation Review tool icon.

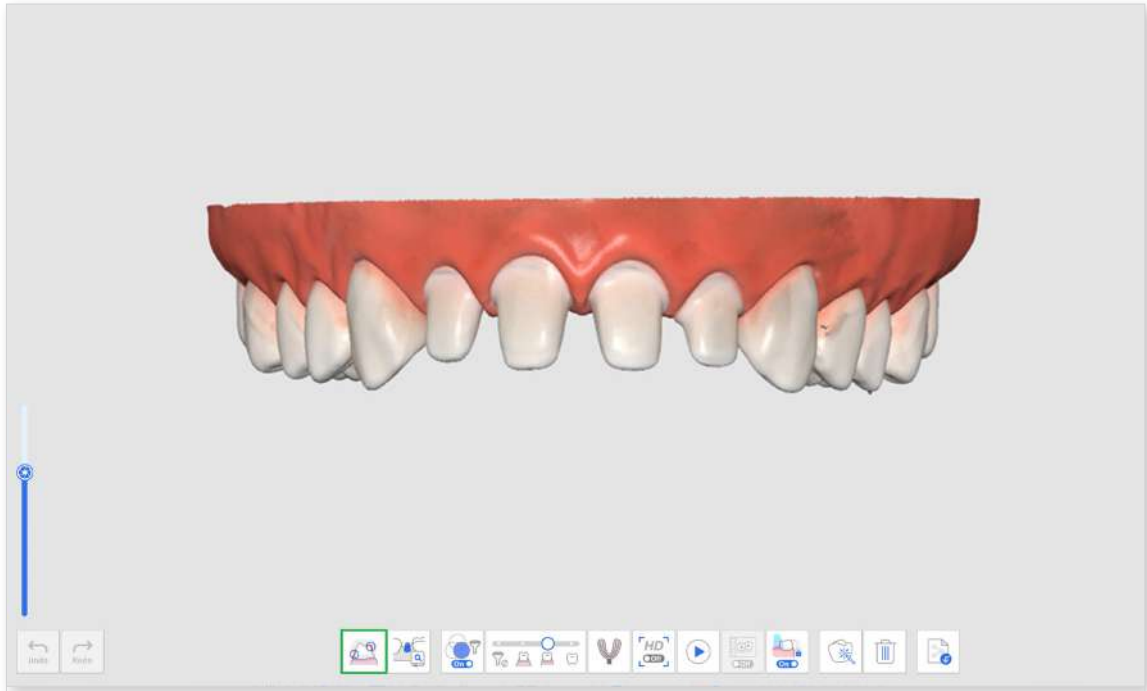

- ② Select an area on the prepared teeth data using the area selection tools.

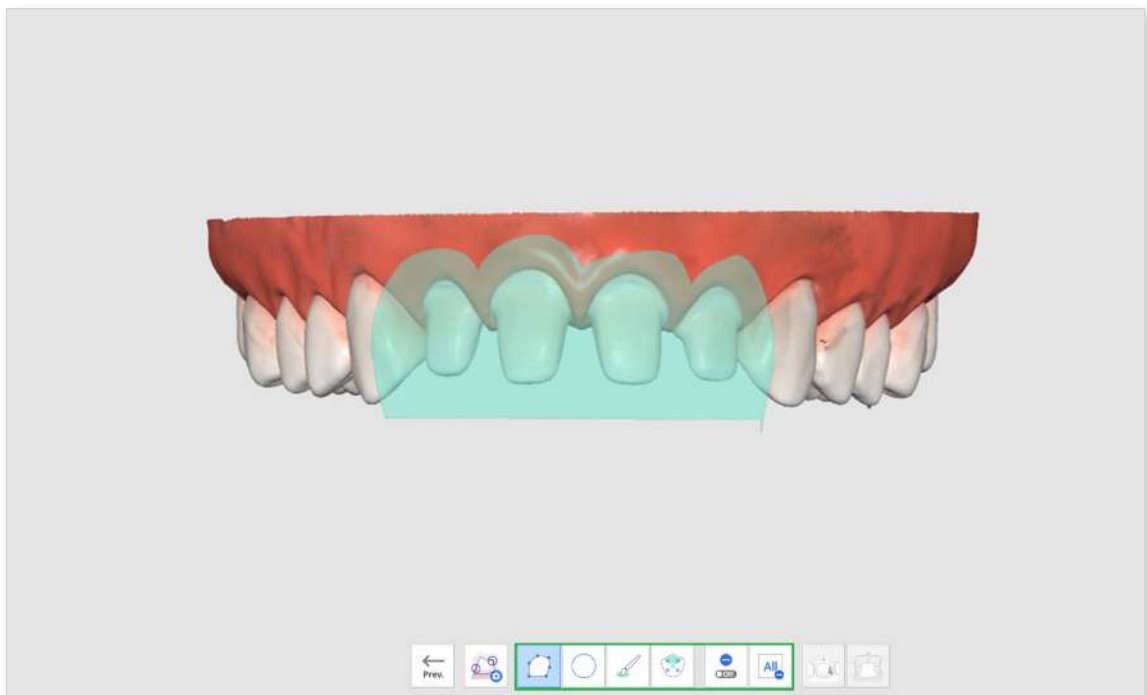

- ③ If you click the Insertion Path icon, an insertion path is automatically created in a direction where undercut areas are minimized.

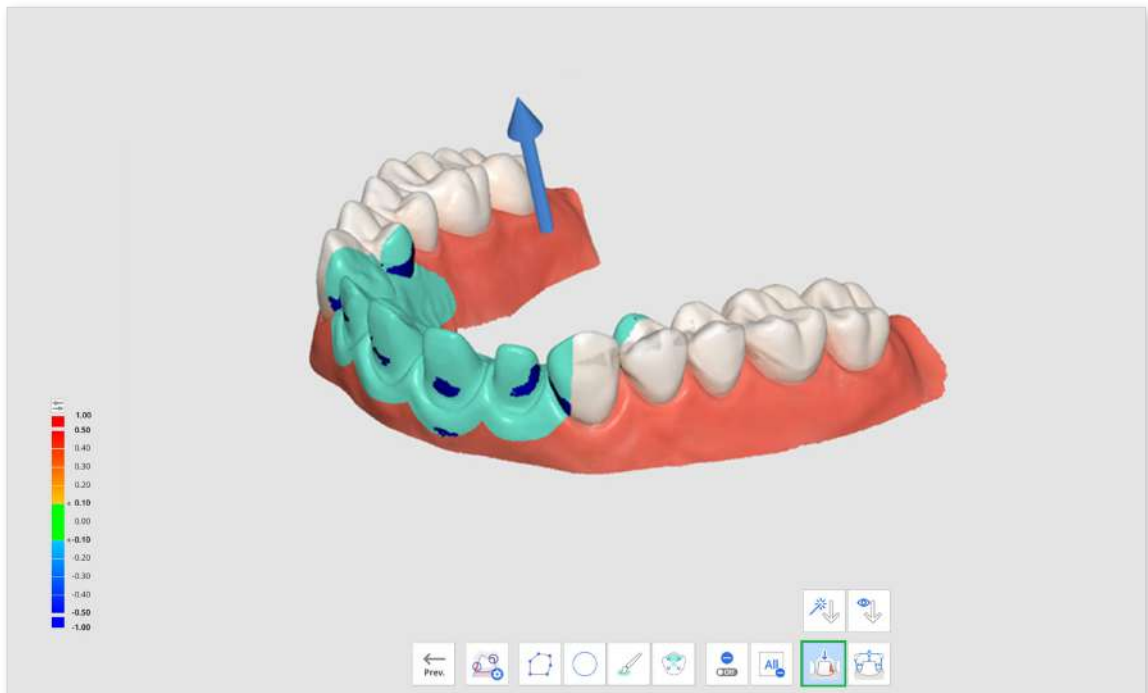

- ④ You can change the insertion direction by clicking and dragging the arrow or using the Manual Direction tool. Based on the insertion path, undercut areas are displayed on the data.
- ⑤ Click the Distances icon and select one of the following tools.
- Tooth Reduction Depth
 - Distance to Antagonist
 - Distance to Adjacent

- ⑥ The areas with insufficient tooth reduction in the scan data are shown in red.

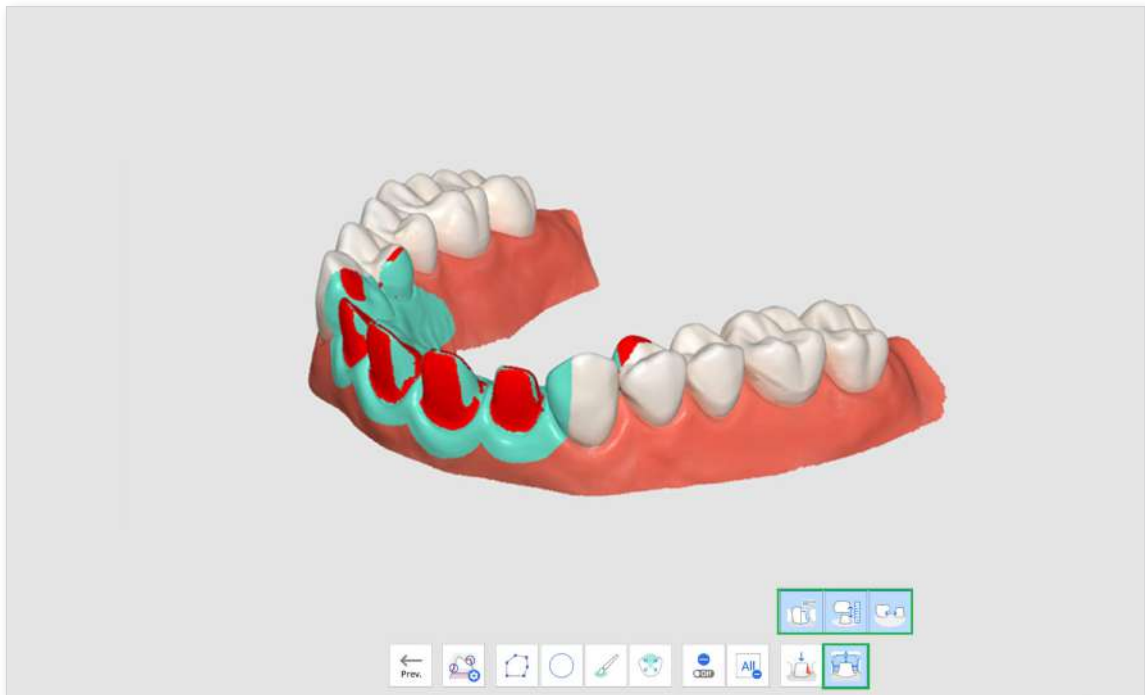

- ⑦ When hovering the mouse over the red area, an image of the insufficient item and its value will be displayed.

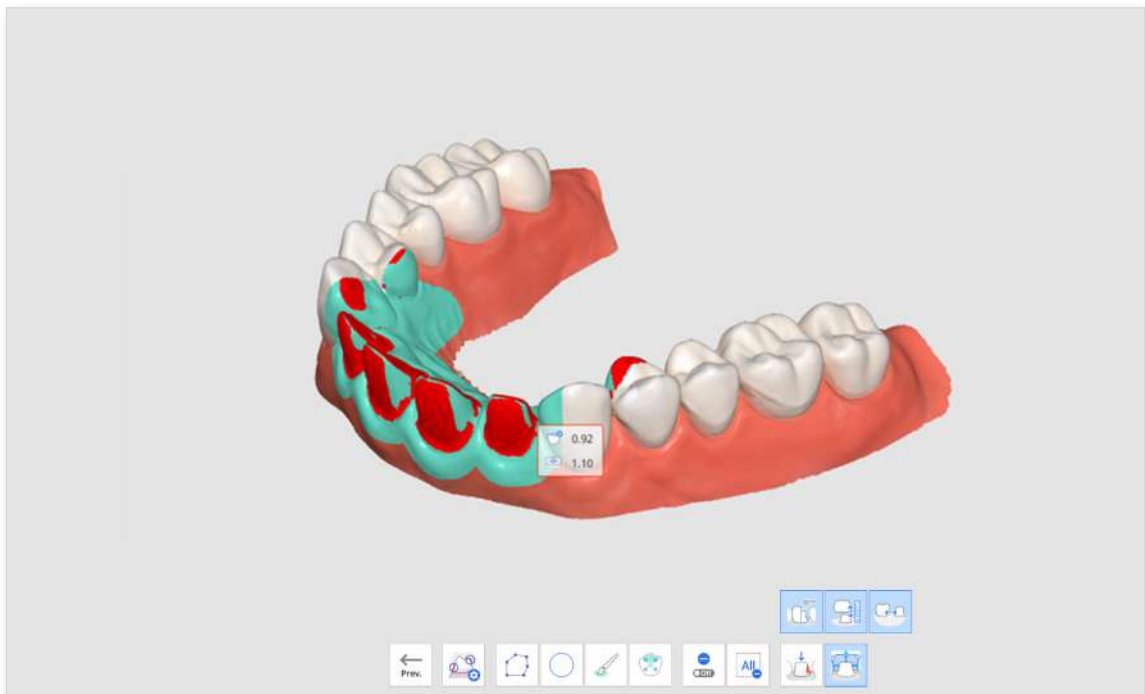

- ⑧ With the displayed values, the user can plan whether additional tooth preparation is needed and how much more to remove.
- ⑨ After additional tooth preparation, you can trim the area and acquire additional scan data. Then, you can go through the Preparation Review again for final confirmation.

